

# Thermal-Magnetic / Magnetic Only Molded Case Circuit Breakers

Catalog  
**2004**

Class 601



## CONTENTS

Description . . . . .	Page
INTRODUCTION . . . . .	6
100 AMPERE FRAME . . . . .	29
225 / 250 AMPERE FRAME . . . . .	54
400 AMPERE FRAME . . . . .	78
600 AMPERE FRAME . . . . .	86
800 / 1000 AMPERE FRAME . . . . .	99
1200 AMPERE FRAME . . . . .	113
2000 / 2500 AMPERE FRAME . . . . .	121
MAGNETIC ONLY MOLDED CASE CIRCUIT BREAKERS . . . . .	139
MOLDED CASE SWITCHES . . . . .	145
ACCESSORIES . . . . .	148



# Thermal-Magnetic / Magnetic Only Molded Case Circuit Breakers



# Thermal-Magnetic / Magnetic Only Molded Case Circuit Breakers

## Table of Contents

<b>INTRODUCTION</b> .....	<b>6</b>
Molded Case Circuit Breaker Types .....	7
Internal Operating Mechanisms .....	9
Circuit Breaker Tripping Characteristics .....	11
Construction .....	13
UL 489 Test Procedures .....	14
Ratings for Molded Case Circuit Breakers .....	16
Return and Exchange Policy .....	22
Catalog Numbers .....	23
<b>100 AMPERE FRAME</b> .....	<b>29</b>
Description .....	29
Applications .....	29
Selection Data .....	30
Powerpact® Selection Data .....	34
Dimensions .....	35
Tripping Curves .....	37
Powerpact® Tripping Curves .....	47
Let-through Curves .....	51
Powerpact® Let-through Curves .....	53
<b>225 / 250 AMPERE FRAME</b> .....	<b>54</b>
Description .....	54
Applications .....	54
Selection Data .....	55
Powerpact® Selection Data .....	57
Dimensions .....	58
Tripping Curves .....	59
Powerpact® Tripping Curves .....	67
Let-through Curves .....	75
Powerpact® Let-through Curves .....	77
<b>400 AMPERE FRAME</b> .....	<b>78</b>
Description .....	78
Applications .....	78
Selection Data .....	78
Dimensions .....	81
Tripping Curves .....	82
<b>600 AMPERE FRAME</b> .....	<b>86</b>
Description .....	86
Applications .....	86
Selection Data .....	86
Dimensions .....	87
Tripping Curves .....	88
Let-through Curves .....	97
<b>800 / 1000 AMPERE FRAME</b> .....	<b>99</b>
Description .....	99
Applications .....	99
Selection Data .....	100
Powerpact® Selection Data .....	101
Dimensions .....	102

# Thermal-Magnetic / Magnetic Only Molded Case Circuit Breakers

## Table of Contents

Tripping Curves . . . . .	103
Powerpact® Tripping Curves . . . . .	111
<b>1200 AMPERE FRAME . . . . .</b>	<b>113</b>
Description . . . . .	113
Applications . . . . .	113
Selection Data . . . . .	113
Dimensions . . . . .	115
Tripping Curves . . . . .	116
<b>2000 / 2500 AMPERE FRAME . . . . .</b>	<b>121</b>
Description . . . . .	121
Applications . . . . .	121
Selection Data . . . . .	121
Dimensions . . . . .	123
Tripping Curves . . . . .	126
<b>MAGNETIC ONLY MOLDED CASE CIRCUIT BREAKERS . . . . .</b>	<b>139</b>
Description . . . . .	139
Characteristics . . . . .	139
Ampere Rating . . . . .	139
Magnetic Adjustment . . . . .	139
Selection Data . . . . .	140
Adjustable Instantaneous-trip Circuit Breakers for Single Motor Circuit Protection . . . . .	141
<b>MOLDED CASE SWITCHES . . . . .</b>	<b>145</b>
Description . . . . .	145
Reverse Connection . . . . .	145
Selection Data . . . . .	145
Powerpact® Selection Data . . . . .	146
Dimensions . . . . .	147
<b>ACCESSORIES . . . . .</b>	<b>148</b>
Factory and Field Installation Types . . . . .	148
Shunt Trip . . . . .	151
Ground Fault Shunt Trip . . . . .	151
Undervoltage Trip . . . . .	152
Undervoltage Trip Time-delay Unit . . . . .	154
Auxiliary Switch . . . . .	155
Alarm Switch . . . . .	156
Micrologic® Ground Fault Module . . . . .	157
Electrical Operators . . . . .	158
Circuit Breaker Handle Accessories . . . . .	163
Circuit Breaker Cylinder Locks . . . . .	163
Walking Beam Mechanical Interlock . . . . .	163
Operating Mechanisms . . . . .	166
UL Listed Terminations . . . . .	167
Control Wire Terminations . . . . .	167
Lug Delete . . . . .	167
Power Distribution Connectors . . . . .	170
Rear Connecting Studs . . . . .	170
I-Line® Accessories . . . . .	171
KA Insert Kit . . . . .	171

# Thermal-Magnetic / Magnetic Only Molded Case Circuit Breakers

## Table of Contents

LC, LI, LE, LX and LXI Circuit Breaker Termination Clip Kit .....	172
Replacement Handles .....	172
Mechanical Key Interlock Adaptor Plate .....	172
Visi-blade® Circuit Breakers .....	173
Sub-feed Lugs .....	173

# Thermal-Magnetic / Magnetic Only Molded Case Circuit Breakers

## Introduction

### INTRODUCTION

This section of the catalog introduces low voltage thermal-magnetic circuit breakers, magnetic only circuit breakers, and molded case switches. It provides an overview which covers:

- Construction standards
- Ratings and tripping characteristics
- Catalog numbers used when ordering (to specify the circuit breakers and accessories used with it)
- Return and exchange policies

The frame size sections contain application information on thermal-magnetic and magnetic only circuit breakers and molded case switches. They are presented in subsections based on their amperage ratings as shown below.

- 100 Ampere Frame
- 225 / 250 Ampere Frame
- 400 Ampere Frame
- 600 Ampere Frame
- 800 Ampere Frame
- 1000 Ampere Frame
- 1200 Ampere Frame
- 2000 / 2500 Ampere Frame
- Magnetic Only
- Molded Case Switches

The section, Accessories, contains the accessories used with thermal-magnetic circuit breakers, magnetic only circuit breakers and molded case switches. Ordering information for the accessories is also provided.

Circuit breakers are designed to protect electrical systems from damage caused by overloads, short circuits, and ground faults. A molded case circuit breaker is defined by the National Electrical Manufacturers Association (NEMA) as, "... a device assembled as an integral unit in supporting and enclosing housing of insulated material, designed to open and close a circuit by non-automatic means, and to open the circuit automatically on a predetermined overcurrent, without injury to itself when properly applied within its rating."

Square D manufactures thermal-magnetic, magnetic only, and electronic trip molded circuit breakers. Thermal-magnetic and magnetic only circuit breakers, along with the molded case switches available from Square D, are described in this catalog. Electronic trip circuit breakers are described in catalog Class 602 *Electronic Trip Molded Case Circuit Breakers* (a separate publication available from Square D). Also, see Class 611, 612, 613, and 734 catalogs for other Powerpact® and Masterpact® circuit breakers.

# Thermal-Magnetic / Magnetic Only Molded Case Circuit Breakers Introduction

## Molded Case Circuit Breaker Types

This catalog discusses the following types of molded case circuit breakers:

- Thermal-magnetic, including current limiting circuit breakers
- Magnetic only (Mag-Gard®) circuit breakers
- Molded case switches



### ■ Thermal-Magnetic Molded Case Circuit Breakers

Thermal-magnetic molded case circuit breakers are the most common overcurrent protection devices. Their primary functions are to provide a means to manually open a circuit and automatically open a circuit under overload or short circuit conditions. Thermal-magnetic circuit breakers use bimetals and electromagnetic assemblies to provide overcurrent protection. Their characteristic inverse time tripping under overload conditions is ideally suited for many applications varying from residential to heavy industrial loads. For higher level (short circuit) overcurrents, instantaneous trip characteristics allow molded case circuit breakers to interrupt with no intentional delay.

#### □ Current Limiting Circuit Breakers

Current limiting circuit breakers are used for overcurrent protection and switching on ac systems where high fault currents may be encountered. They have permanent trip units containing individual thermal and magnetic trip elements in each pole like thermal-magnetic circuit breakers. But they go one step further by limiting the amount of current that normally passes through a circuit breaker during a severe fault on the circuit being protected. Square D® current limiting circuit breakers are designed to take advantage of the electromagnetic repulsion created by closely spaced, parallel contact arms carrying current in opposite directions. This repulsion, intensified by an “O” shaped magnet surrounding the contact arms, causes the contacts to blow open in less than one millisecond under fault conditions above 10 to 15 times the handle rating of the circuit breaker. This high speed contact separation enhances the ability of the I-Limiter® circuit breakers to limit both peak current and  $I^2t$  let-through energy. UL requires that peak current and  $I^2t$  let-through curves be available for current limiting circuit breakers.

The following steps describe the short circuit interrupting process of current limiting circuit breakers at fault levels within the current limiting range:

1. **Contacts Part**—The electromagnetic repulsion between the contact arms exceeds the spring force that holds the contact arms together. The repulsion blows the contact open.
2. **Limited Peak Current Reached**—The intense magnetic field inside the “O” shaped magnet forces the arc (between the opening contacts) into the stack plates.
3. **Limiter Latch Holds Contacts Open**—After  $I_p$  has been reached, the current must then be driven to zero. At the same time this occurs, a specially designed limiter latch holds the contacts open until interruption is complete.
4. **Interruption Complete**—To complete interruption, the arc voltage is sustained at a high enough level to overcome source voltage and thereby drive the current to zero (complete interruption). This requires a rapid rise in arc resistance and is accomplished by maintaining arc length while



**FIL**  
Current Limiting  
Circuit Breaker

# Thermal-Magnetic / Magnetic Only Molded Case Circuit Breakers

## Introduction

quickly cooling the arc. Cooling the arc causes a loss of ionization which increases arc resistance.

### ■ Magnetic Only Circuit Breakers

Mag-Gard® magnetic only circuit breakers comply with National Electrical Code (NEC) requirements for providing motor circuit protection when installed as part of a listed combination controller having motor overload protection.

Mag-Gard instantaneous trip circuit breakers (often referred to as motor circuit protectors) are similar in construction to thermal-magnetic circuit breakers. They are designed as disconnect devices for use in combination with motor starters. Mag-Gard circuit breakers are built without thermal detection elements (bimetals), therefore, they provide short circuit protection only. Mag-Gard circuit breakers have an adjustable amperage pick up so they can be set to open instantaneously at current values slightly above the motor starting inrush current. This setting coordinates the pick-up time-current response of the Mag-Gard with the overload relay of the starter to give the best possible motor protection. According to the 2002 NEC, “Where the setting specified in Table 430.52 is not sufficient for the starting current of the motor, the setting of an instantaneous trip circuit breaker shall be permitted to be increased but shall in no case exceed 1300 percent of the motor full-load current for other than Design E motors or Design B energy efficient motors and no more than 1700 percent of full-load motor current for Design E motors or Design B energy efficient motors. Trip settings above 800 percent for other than Design E motors or Design B energy efficient motors and above 1100 percent for Design E motors or Design B energy efficient motors shall be permitted where the need has been demonstrated by engineering evaluation. In such cases, it shall not be necessary to first apply an instantaneous-trip circuit breaker at 800 percent or 1100 percent.” Current interrupting ratings for these UL recognized components are established in combination with motor starters and properly sized overload relays and contactors. Mag-Gard circuit breakers are tested in combination with Square D® starters per UL Standard 845.

### ■ Molded Case Switches

Molded case switches are intended for use as disconnect devices only. UL Standard 489 requires molded case switches to be protected by a thermal-magnetic circuit breaker (or fuse) of equivalent rating. Molded case switches are labeled with their appropriate withstand ratings. Withstand rating is defined as the maximum current, at rated voltage, that the molded case switch will withstand, without damage, when protected by a circuit breaker (or fuse) with an equal continuous current rating.

Automatic molded case switches are similar in construction to thermal-magnetic circuit breakers, except that the thermal detection element is not present. These switches open instantaneously at a non-adjustable, factory preset, magnetic trip point calibrated to protect only the molded case construction, they are more compact than conventional disconnect switches and accept electrical accessories for added flexibility.

The following molded case switches are available from Square D:

**Table 1: Molded Case Switches**

FH	100 Ampere Frame
HD, HG, HJ, HL★	15–150 Ampere Frame
QB, QD, QG, QJ★	70–250 Ampere Frame
KH	250 Ampere Frame
JD, JG, JJ, JL★	150–250 Ampere Frame
LH	400 Ampere Frame
M-frame★	300–800 Ampere Frame
MH	600-1000 Ampere Frame
NC	1200 Ampere Frame
PH	2000 Ampere Frame
PC	2500 Ampere Frame

★ See Powerpack® H- and J-frame catalog, Class 611, for more information. Also, see Class 612, 613, and 734 catalogs for other Powerpack and Masterpack® circuit breakers.



FAL  
Magnetic Only  
Circuit Breaker



KHL  
Automatic Molded  
Case Switch

# Thermal-Magnetic / Magnetic Only Molded Case Circuit Breakers

## Introduction

### Internal Operating Mechanisms

The following mechanisms allow the circuit breaker to operate:

- Thermal trip
- Magnetic trip
- Push-to-trip button
- Shunt trip
- Undervoltage trip

*NOTE: Shunt trip and undervoltage trip are described in the Accessories section.*

#### ■ Tripping Mechanism

The tripping mechanism is an assembly within the circuit breaker frame that causes the circuit breaker to open automatically under sustained overload, short circuit, or high level ground fault conditions.

The tripping mechanisms in 2- and 3-pole circuit breakers operate such that an overcurrent on any given pole of the circuit breaker will cause all poles of the circuit breaker to open simultaneously. A thermal and magnetic factory calibration test (with current) is performed on each pole of every circuit breaker manufactured by Square D®.

The sensing system of a thermal-magnetic circuit breaker is an integral part of the circuit breaker that continually monitors the current flowing through the circuit breaker. It detects abnormal current conditions and, depending on the magnitude of the current, initiates an inverse-time or an instantaneous tripping response. This action causes the tripping mechanism to open the circuit breaker contacts and interrupt current flow. The speed of the tripping process must be controllable and inversely matched to the severity of the overcurrent. The ability of a particular circuit breaker to interrupt a given level of overcurrent depends on the sensitivity of the circuit breaker.

Thermal-magnetic circuit breakers have two tripping elements.

#### □ Thermal Trip

The molded case circuit breaker thermal trip element is a root means squared (RMS) sensing device. The bimetal thermal element is constructed from metals of dissimilar rates of expansion bonded together. The thermal portion responds to overloads by reacting to the heat generated both by the current flowing through the circuit breaker and by the heat contribution from the ambient conditions. The bending force of the bimetal causes the circuit breaker to trip. The deflection of the bimetal is predictable as a function of current and time. This is the inverse time tripping characteristics of the thermal element (i.e., the tripping time decreases as the magnitude of the current increases).

Square D calibrates the thermal elements for a specific amperage rating, and they are not field adjustable. The thermal trip elements are calibrated for 40° C ambient temperature per UL Standard 489.

**Figure 1: Thermal Trip Condition**

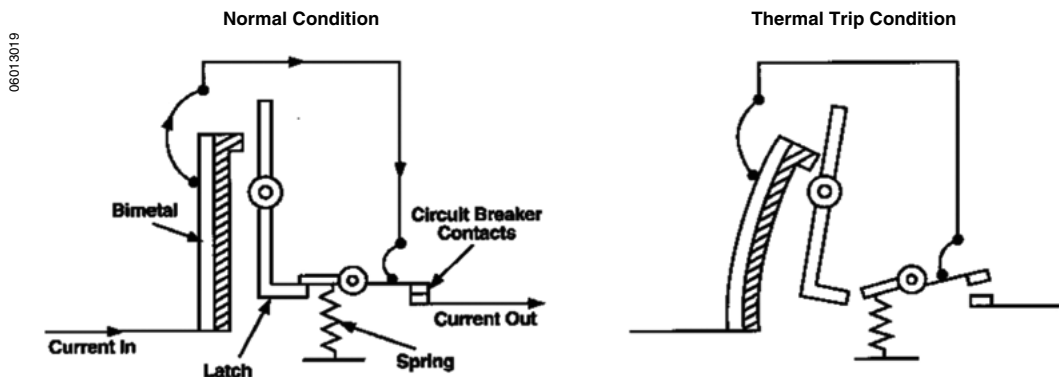

# Thermal-Magnetic / Magnetic Only Molded Case Circuit Breakers

## Introduction

### □ Magnetic Trip

The magnetic (instantaneous) trip element uses an electromagnetic assembly, in series with the load current, to trip the circuit breaker instantaneously (with no intentional delay) at or above a predetermined current value. During a short circuit of significant magnitude, the high level current passing through the conductor rapidly increases the magnetic field of the electromagnet which attracts the armature. As the armature is drawn toward the electromagnet, it initiates an unlatching action and opens the circuit breaker contacts.

Figure 2: Magnetic Trip Condition

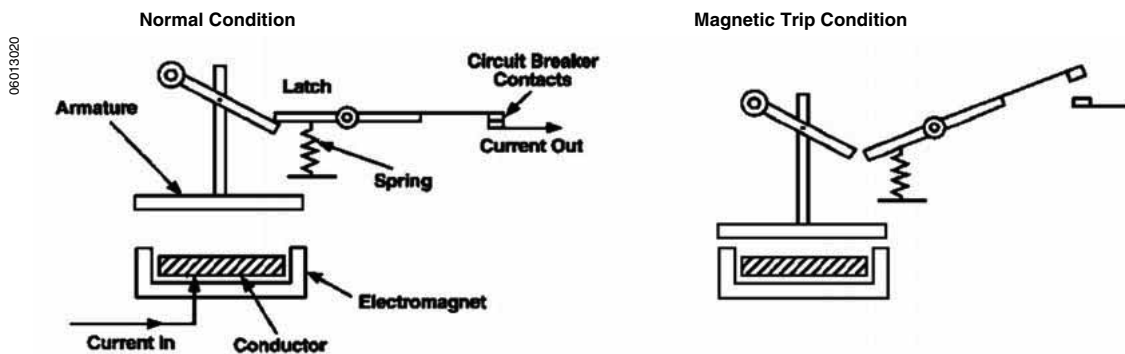

### ■ Line and Load Connections

Thermal-magnetic circuit breakers, magnetic only circuit breakers, and molded case switches are provided with factory installed UL Listed mechanical-type aluminum alloy lugs suitable for either aluminum or copper wire. In addition to mechanical lugs, Square D can supply copper mechanical lugs, aluminum or copper Versa-Crimp® compression lugs, and power distribution connectors. Circuit breakers can be ordered without lugs to accept bus connections.

Figure 3: Mechanical and Versa-Crimp Lugs



Square D also offers I-Line® circuit breakers, which feature plug-on connectors. They are designed for easy installation and removal of the circuit breakers in our exclusive I-Line panelboards. I-Line circuit breakers use “blow-on” type connectors. In case of a short circuit, in the circuit being protected, the increased magnetic flux causes the plug-on connectors to grasp the panelboard bus bars even tighter. These connectors are an integral part of the I-Line circuit breakers, as is the breaker mounting bracket.

### ■ Push-To-Trip Button

Push-To-Trip is a standard feature of Square D® molded case circuit breakers that allows the circuit breaker to be manually tripped without exposure to live parts. The Push-To-Trip button is located on the face of each molded case circuit breaker for ease of periodic operation.

International I/O (ON/OFF) markings appear on the face of each Square D molded case circuit breaker and molded case switch in addition to the standard ON/OFF markings to indicate handle position. When tripped, the handle assumes a center position. To reset the breaker, the handle is moved to the

# Thermal-Magnetic / Magnetic Only Molded Case Circuit Breakers

## Introduction

OFF position and then to the ON position. During normal on/off operation, the handle opens and closes the circuit breaker contacts but does not exercise the tripping mechanism. Square D suggests that the circuit breaker's tripping mechanism be exercised at least annually. Use of the Push-To-Trip system will also check:

- Alarm circuits
- Emergency circuits
- Motor sequencing operations

For maintenance information, application, and field testing guides contact your local Square D sales office 1-888 Square D.

### Circuit Breaker Tripping Characteristics

The tripping characteristics of thermal-magnetic molded case circuit breakers can be represented by a characteristic tripping curve that plots tripping time versus current level. The curve shows the amount of time required for a circuit breaker to trip for currents ranging from minor overloads to maximum interrupting capacity.

#### ■ Thermal Tripping Characteristics

The left-hand portion of a tripping curve displays the circuit breaker's thermal response. On low level overcurrents, up to the magnetic tripping level, thermal tripping occurs when a bimetal in the circuit breaker responds to heat associated with overcurrent. The bimetal deflects, unlatching the mechanism, which causes the circuit breaker contacts to open. The larger the overcurrent, the faster the circuit breaker operates to open the circuit (inverse time).

#### ■ Magnetic Tripping Characteristics

Figure 4: FI Characteristic Tripping Curve

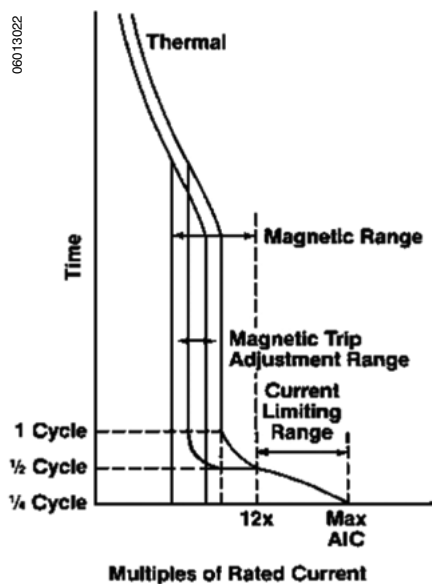

The right hand portion of a tripping curve displays the magnetic tripping response of the circuit breaker. This takes place when overcurrents of sufficient magnitude operate an internal magnetic armature that unlatches the tripping mechanism. Magnetic tripping occurs with no intentional delay.

For example, the FI circuit breaker time current characteristic tripping curve shows the tripping response of the circuit breaker for currents ranging from minor overloads to maximum interrupting capacity.

#### ■ Circuit Breaker Coordination

To determine what level of coordination exists between molded case circuit breakers, a comparison of circuit breaker characteristic tripping curves is necessary.

A coordination study is an organized effort to achieve optimum electrical distribution system protection by determining the appropriate frame sizes, ampere ratings, and settings of overcurrent protective devices. When an overcurrent within the coordination limits occurs in a distribution system, only the protective device nearest the overload or fault opens. Lack of coordination between overcurrent devices can result in upstream devices opening and interrupting electrical distribution in other parts of the system.

# Thermal-Magnetic / Magnetic Only Molded Case Circuit Breakers

## Introduction

■ Let-through Current Curves

Figure 5: Maximum Instantaneous Let-through Current

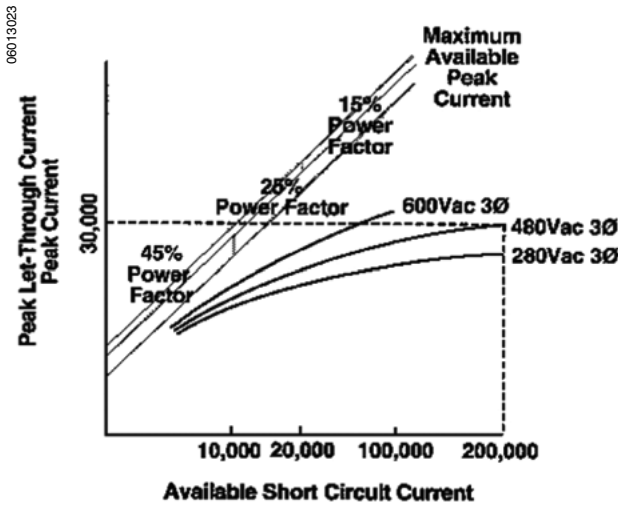

Let-through current curves show the extent to which a current limiting circuit breaker limits the peak current that could flow during a short circuit. On these curves, the slanting straight lines marked 15%, 25% and 45% power factor show the maximum theoretical peak currents that could flow in a faulted circuit having that particular short circuit power factory—with NO current limiting device in the circuit.

Short circuits which produce high fault currents typically are associated with low short circuit power factors; that is, high X/R ratios. Since different portions of a system will exhibit various available fault levels and power factors associated with those levels, UL has established that the following power factors be used in short circuit testing:

Table 2: Power Factors in Short Circuit Testing

Test Current RMS Symmetrical (Amperes)	Power Factor (%)
10,000 or Less	45-50
10,000-20,000	25-30
Over 20,000	15-20

Since the peak current let-through curves for the I-Limiter<sup>®</sup> current limiting circuit breakers were derived from tests at the current levels and power factors indicated, the degree of current limitation is expressed by the differential between the maximum available peak current and the actual test let-through peak current.

The curves extend from the threshold of current limitation through the maximum interrupting rating of the current limiting circuit breaker.

# Thermal-Magnetic / Magnetic Only Molded Case Circuit Breakers

## Introduction

Figure 6: Maximum Let-through  $I^2t$  Energy

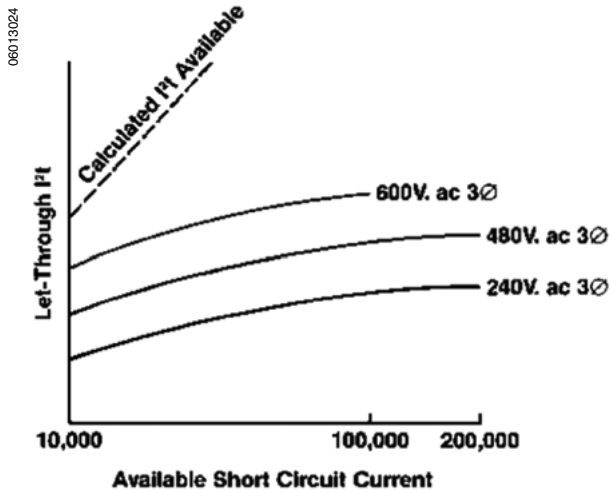

Let-through  $I^2t$  curves show the extent to which the current limiting circuit breaker limits energy let-through under short circuit conditions. The theoretical  $I^2t$  let-through of symmetrical sinusoidal current can be calculated. At 100,000 amperes rms, this would be  $83 \times 10^6$  ampere<sup>2</sup> seconds for  $\frac{1}{2}$  cycle if NO CURRENT LIMITING DEVICE WERE IN THE CIRCUIT. In contrast, the curves show that with the same level of 100,000 rms symmetrical short circuit amperes available, the 100 ampere current limiting circuit breaker would limit the energy flow  $0.62 \times 10^6$  ampere<sup>2</sup> seconds at 480 volts or  $0.27 \times 10^6$  ampere<sup>2</sup> seconds at 240 volts.

### Construction

Thermal-magnetic circuit breakers are manufactured and tested according to the following standards and files:

- Underwriters Laboratories Inc. (UL) Listed to UL489 Standard, File E10027,
- National Electrical Manufacturers Association (NEMA) AB-1 Standard,
- Canadian Standards Association (CSA) Certified to CSA C22.2 No. 5-02 Standard, File LR7551,
- International Electrotechnical Commission (IEC) 60947-2 Standard,
- Federal Specification W-C-375B/GEN as Class 11a, 11b; 12a, 12b; and 13a, 13b.

Magnetic only circuit breakers are manufactured and tested according to the following standards and files:

- Underwriters Laboratories Inc. (UL) Recognized to UL489 Standard, File E10027,
- Canadian Standards Association (CSA) Certified to CSA C22.2 No. 5-02 Standard, File LR32390.

Molded case switches are manufactured and tested according to the following standards and files:

- Underwriters Laboratories Inc. (UL) Listed to UL489 Standard, File E33117 or E87159,
- Canadian Standards Association (CSA) Certified to CSA C22.2 No. 5-02 Standard, File LR32390 or LR40970.

*NOTE: Circuit breakers are to be applied by guidelines detailed in the NEC and other local electrical codes.*

#### ■ Specifications

Cases for molded case circuit breakers are constructed of a glass-reinforced insulating material that provides high dielectric strength. Current carrying components are isolated from the handle and accessory mounting area. The handle position indicates whether the circuit breaker is OFF, ON or tripped.

Square D<sup>®</sup> molded case circuit breakers:

- have common tripping of all poles,
- are equipped with a Push-To-Trip button to manually trip the circuit breaker,
- can be mounted and operated in any position,
- are fully tested, UL listed, CSA certified, and IEC rated for reverse connection without restrictive "LINE" or "LOAD" markings.

# Thermal-Magnetic / Magnetic Only Molded Case Circuit Breakers

## Introduction

### ■ Tripping System

Square D® thermal-magnetic molded case circuit breakers have a permanent trip unit that contains a factory preset thermal trip element and a magnetic trip element in each pole. The thermal trip element is rms sensing. In circuit breakers with frame sizes greater than 100 ampere, the magnetic trip element is field adjustable. A single adjustment simultaneously adjusts the instantaneous trip point in each pole.

### ■ Terminations

All factory installed mechanical type lugs are UL Listed to accept solid or stranded conductors and can be used with wire rated at 60° C, 75° C, and 90° C (sized according to the NEC 75° C temperature rating). Most molded case circuit breakers are UL Listed to accept field installable mechanical type and compression type lugs.

### ■ UL Requirements.

A UL label on a Square D molded case circuit breaker indicates that the circuit breaker meets the requirements of UL Standard 489 for circuit breakers.

A UL label also means the production procedure is monitored by UL inspectors for continuing conformance to UL performance requirements. These requirements are based on sound engineering principles, research, records of test and field experience, and information gathered from users and inspection authorities. These requirements are subject to revision as necessary.

### ■ UL HACR Type

All UL 489 listed molded case circuit breakers are HACR type.

## UL 489 Test Procedures

### ■ Limited Available Fault Current Tests

UL requires a series of tests on a single set of sample circuit breakers for compliance with UL Standard 489. The tests for thermal-magnetic breakers are described below.

Since molded case switches are derivatives of molded case circuit breakers, some testing of switches is identical to that for circuit breakers. These tests include a 600% overload performance test.

#### ❑ 200% Thermal Calibration

Each pole of the circuit breaker must trip within a specified time limit when carrying 200% of its continuous current rating.

#### ❑ 135% Thermal Calibration

With all poles connected in series, the circuit breaker must trip within a specified time limit when carrying 135% of its continuous current rating.

#### ❑ Magnetic Calibration

If the circuit breaker has an adjustable magnetic tripping means, then it must trip within a specified percentage of the marked tripping current.

#### ❑ Overload

The circuit breaker is operated making and breaking 600% of its continuous current rating, but not less than 150 ampere.

For circuit breakers through 1600 ampere, the number of 600% operations is 50. For larger circuit breakers to 4000 ampere, the number of operations is 25.

#### ❑ Temperature Rise

While carrying 100% of rated current at a 40° C ambient temperature and mounted in open air, the circuit breaker is checked for temperature rise on a wiring terminal. The temperature on the terminal shall not exceed a 50° C rise above ambient temperature and must be within specified limits.

#### ❑ Endurance

The circuit breaker must successfully complete the following number of switching operations:

# Thermal-Magnetic / Magnetic Only Molded Case Circuit Breakers Introduction

**Table 3: Circuit Breaker Endurance**

Frame Size Amperes	Full Load Operations	No Load Operations
0-100	6,000	4,000
101-225	4,000	4,000
226-600	1,000	5,000
601-800	500	3,000
801-2500	500	2,000
2501-4000	400	1,100

Calibration Retest

Both the 200% and 135% thermal calibration tests are repeated.

Short Circuit

For circuit breakers rated 240 Vac and higher, two short circuit tests per pole and one test with all poles connected in series is performed. For example, a 3-pole circuit breaker receives seven short circuit tests.

For circuit breakers rated 120/240 Vac, three tests are made with all poles connected in series.

The circuit breaker is connected to the test circuit using wire correctly sized for the rating of the circuit breakers. The line leads are not more than four feet in length and the load leads are not more than 10 inches in length.

*NOTE: Successful testing requires that the current be interrupted while monitoring the integrity of the line-end load connection.*

Trip Out

The 200% thermal calibration test is repeated following the short circuit tests.

Dielectric

The circuit breaker must withstand, for one minute, twice its rated voltage plus 1000 Vac:

- between line and load terminals with the circuit breaker open, that is, with the circuit breaker in the tripped and off positions,
- between terminals of opposite polarity with the circuit breaker closed, and
- between live parts and the overall enclosure with the circuit breaker both open and closed.

No conditioning of the circuit breaker can take place during or between these tests. There also can be no failure of functional parts at the conclusion of the sequences.

High Available Fault Current Tests

After qualifying a set of circuit breakers to the standard tests, a manufacturer can have additional circuit breaker samples tested on higher than standard available fault currents.

The following performance requirements apply:

200% Thermal Calibration

Each pole of the circuit breaker must trip within a specified time limit when carrying 200% of its continuous current rating.

Short Circuit

With the load side terminals connected by 10-inch lengths of specified cable, the circuit breaker is exposed to a short circuit current for a set time interval. After safe interruption, the circuit breaker is reset and closed again on the short circuit.

250% Thermal Calibration

Each pole of the circuit breaker must trip within a specified time limit when carrying 250% of its continuous current rating.

# Thermal-Magnetic / Magnetic Only Molded Case Circuit Breakers

## Introduction

### ❑ Dielectric Withstand

The circuit breaker is subjected to twice its rated voltage, but not less than 900 Vac.

When the sample circuit breaker passes these tests, breakers of the same construction can be marked or labeled with the higher current interrupting rating.

### ■ Switching Duty

The switching duty (SWD) listing applies only to 15 ampere and 20 ampere circuit breakers rated at 277 Vac or less. The circuit breakers are subjected to specified temperature rise tests at predetermined periods during the endurance operations.

### ■ Performance Requirements for Magnetic Trip Only Circuit Breakers

Design performance verification is tested as follows:

1. Verification of calibration
2. Overload
3. Temperature rise
4. Mechanical and electrical endurance
5. Limited fault current
6. Re-verification of calibration
7. Dielectric

## Ratings for Molded Case Circuit Breakers

Molded case circuit breakers are selected by their ratings. The ratings must meet or exceed the parameters of the electrical system on which they are used.

### ■ Voltage Rating

A circuit breaker may be rated either for alternating current (ac) or direct current (dc) system applications. The established voltage rating of a circuit breaker is based on design parameters such as clearance of current carrying parts and dielectric withstand tests both through air and over surfaces. Voltage ratings indicate the maximum voltage for the electrical system on which the circuit breaker can be applied. UL Standard 489 recognizes the following ratings:

**Table 4: UL Standard 489 Recognized Voltage Ratings**

Volts for Alternating Current (ac)	Volts for Direct Current (dc)
120	125
120/240	125/250
240	250
277	600
480Y/277	
480	
600	

A circuit breaker can be rated for either ac or dc system applications or both. Circuit breaker voltage ratings must be equal to or greater than the nominal voltage of the electrical system on which they are used.

Paragraph 240.85 of the 2002 NEC states that a circuit breaker must be applied in the following manner:

**240.85**—A circuit breaker with a straight voltage rating, such as 240 V or 480 V, shall be permitted to be applied in a circuit in which the nominal voltage between any two conductors does not exceed the circuit breaker's voltage rating. A two-pole circuit breaker shall not be used for protecting a 3-phase, corner-grounded delta circuit unless the circuit breaker is marked 1Ø-3Ø to indicate such suitability.

# Thermal-Magnetic / Magnetic Only Molded Case Circuit Breakers

## Introduction

A circuit breaker with a slash rating, such as 120/240 V or 480Y/277 V, shall be permitted to be applied in a solidly grounded circuit where the nominal voltage of any conductor to ground does not exceed the lower of the two values of the circuit breaker's voltage rating and the nominal voltage between any two conductors does not exceed the higher value of the circuit breaker's voltage rating.

FPN: Proper application of molded case circuit breakers on 3-phase systems, other than solidly grounded wye, particularly on corner grounded delta systems, considers the circuit breakers' individual pole-interrupting capability.

### ■ Continuous Current Rating

The continuous current rating (or handle rating) of a circuit breaker is defined by NEMA as: "The maximum direct current or rms current, in amperes, at rated frequency which a device or assembly will carry continuously without exceeding the specified limits of observable temperature rise." Continuous current amperage ratings established by the 2002 NEC, paragraph 240.6 are: 15 A, 20 A, 25 A, 30 A, 35 A, 40 A, 45 A, 50 A, 60 A, 70 A, 80 A, 90 A, 100 A, 110 A, 125 A, 150 A, 175 A, 200 A, 225 A, 250 A, 300 A, 350 A, 400 A, 450 A, 500 A, 600 A, 700 A, 800 A, 1000 A, 1200 A, 1600 A, 2000 A, 2500 A, 3000 A, 4000 A, 5000 A, 6000 A.

Paragraph 210.20 (A) and 215.3 of the 2002 NEC states:

**210.20 (A)**—Where a branch circuit supplies continuous loads or any combination of continuous and noncontinuous loads, the rating of the overcurrent device shall not be less than the noncontinuous load plus 125 percent of the continuous load.

*Exception: Where the assembly, including the overcurrent devices protecting the branch circuit(s), is listed for operation at 100 percent of its rating, the ampere rating of the overcurrent device shall be permitted to be not less than the sum of the continuous load plus the noncontinuous load.*

**215.3**—Feeders shall be protected against overcurrent in accordance with the provisions of Part I of Article 240. Where a feeder supplies continuous loads or any combination of continuous and noncontinuous loads, the rating of the overcurrent device shall not be less than the noncontinuous load plus 125 percent of the continuous load.

*Exception No. 1: Where the assembly, including the overcurrent devices protecting the feeder(s), is listed for operation at 100 percent of its rating, the ampere rating of the overcurrent device shall be permitted to be not less than the sum of the continuous load plus the noncontinuous load.*

*Exception No. 2: Overcurrent protection for feeders over 600 volts, nominal, shall comply with Part IX of Article 240.*

NEC defines a continuous load as: "A load where the maximum current is expected to continue for three hours or more."

UL Standard 489 states that circuit breakers must carry 100% of their continuous current rating indefinitely (without tripping) at 40° C in free air. Thermal-magnetic circuit breakers are sized per the NEC for 80% continuous current ratings in the intended enclosure. The continuous current rating is indicated on the front of each circuit breaker.

### ■ Interrupting Ratings

Square D® thermal-magnetic molded case circuit breakers can be standard interrupting, high interrupting, extra high interrupting, and time current limiting in construction and are UL Listed for the interrupting ratings as shown below.

UL recognizes component combinations (circuit breaker / circuit breaker and fuse / circuit breaker) for series connected interrupting ratings. All series rated combinations are marked on the end use equipment along with the statement, "Caution—Series Rated System."

For 100% rated applications, see Class 602, 611, 612, and 613 catalogs for more information.

# Thermal-Magnetic / Magnetic Only Molded Case Circuit Breakers

## Introduction

**Table 5: UL Listed Interrupting Ratings in kA (RMS Symmetrical Amperes)**

Ampacity	Catalog Prefix	Maximum Voltage	UL Listed Interrupting ratings (in kA)					
			240 Vac	480 Vac	600 Vac	125 Vdc	250 Vdc	500 Vdc
<b>Standard Interrupting</b>								
15–100	FA	600 Vac	25	18	14	10	10	—
		480 Vac	25	18	—	10	10	—
		240 Vac	10	—	—	5	5	—
70–250	KA	600 Vac	42	25	22	10	10	—
125–600	LA	600 Vac	42	30	22	10	10	—
300–1000	MA	600 Vac	42	30	22	10	10	—
600–1200	NA	600 Vac	100	50	25	—	—	—
600–2000	PA	600 Vac	65	50	42	—	—	—
<b>High Interrupting</b>								
15–100	FH	600 Vac	65	25	18	50	50	—
70–250	KH	600 Vac	65	35	25	50	50	—
125–400	LH	600 Vac	65	35	25	50	50	—
300–1000	MH	600 Vac	65	65	25	50	50	—
600–2000	PH	600 Vac	125	100	65	—	—	—
15–100	FH-DC	500 Vdc	—	—	—	—	—	20
70–250	KH-DC	500 Vdc	—	—	—	—	—	20
125–400	LH-DC	500 Vdc	—	—	—	—	—	20
300–1000	MH-DC	500 Vdc	—	—	—	—	—	20
600–2500	PA-DC	500 Vdc	—	—	—	—	—	25
<b>Extra High Interrupting</b>								
15–100	FC	480 Vac	100	65	—	—	—	—
110–250	KC	480 Vac	100	65	—	—	—	—
300–600	LC	600 Vac	100	65	35	—	—	—
600–1200	NC	600 Vac	125	100	65	—	—	—
1600–2500	PC	600 Vac	125	100	65	—	—	—
<b>Current Limiting</b>								
20–100	FI	600 Vac	200	200	100	—	—	—
110–250	KI	600 Vac	200	200	100	—	—	—
300–600	LI	600 Vac	200	200	100	—	—	—

*NOTE: These ratings apply to I-Line<sup>®</sup> circuit breakers and circuit breakers with or without lugs.*

# Thermal-Magnetic / Magnetic Only Molded Case Circuit Breakers Introduction

**Table 6: Powerpact® UL Listed Interrupting Ratings in kA (RMS Symmetrical Amperes)**

Ampacity	Catalog Prefix	Maximum Voltage	UL Listed Interrupting ratings (in kA)					
			240 Vac	480 Vac	600 Vac	125 Vdc	250 Vdc	500 Vdc
15–150	HD	600 Vac	25	18	14	20	20	TBD
	HG		65	35	18			
	HJ		100	65	25			
	HL		125	100	50			
70–250	QB	240 Vac	10	—	—	—	—	—
	QD	240 Vac	25	—	—	—	—	—
	QG	600 Vac	65	—	—	—	—	—
	QJ	240 Vac	100	—	—	—	—	—
150–250	JD	600Vac	25	18	14	20	20	TBD
	JG		65	35	18			
	JJ		100	65	25			
	JL		125	100	50			
300–800	MG	600 Vac	65	35	18	—	—	—
	MJ		100	65	25	—	—	—

The ampere interrupting rating (AIR) of a circuit breaker is the highest current at rated voltage that the circuit breaker is intended to interrupt under standard test conditions. The interrupting rating is shown on the faceplate of the circuit breaker for each voltage level that the circuit breaker can use. Circuit breakers are selected with interrupting ratings equal to or greater than the available short circuit current at the point where the circuit breaker is applied in the system. Circuit breaker interrupting ratings are commonly expressed in rms symmetrical amperes. The industry standardization on rms symmetrical ampere ratings takes into account asymmetrical current conditions by specifying a power factor in the test circuit.

**Figure 7: Circuit Breaker Faceplate Label**

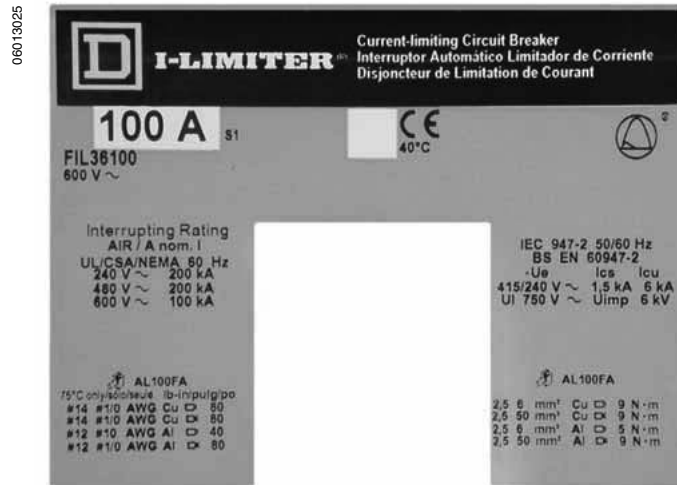

■ **Ambient Temperature Rating**

To meet the requirements of UL Standard 489, CSA, and IEC, molded case circuit breakers are designed, built and calibrated for use on 50/60 Hertz (Hz) ac systems in a 40° C ambient temperature.

The ambient temperature is the temperature of the air surrounding a circuit breaker. Thermal-magnetic circuit breakers are temperature sensitive devices, and their rated continuous current carrying capacity is based on a UL specified 40° C calibration temperature. The ambient temperature can affect the thermal (overload) tripping characteristics of thermal-magnetic circuit breakers. When applying the

# Thermal-Magnetic / Magnetic Only Molded Case Circuit Breakers

## Introduction

circuit breaker at a temperature other than 40° C, it may be necessary to rerate the circuit breaker to compensate for ambient conditions. Conductors are sized using the ampacity rerating factors shown in NEC Table 310-16 when designating systems for ambient temperatures other than 40° C.

Thermal-magnetic circuit breakers use bimetal strips that bend in response to temperature changes. Current flowing through the circuit breaker creates most of the heat that causes the tripping action. The ambient temperature surrounding the circuit breaker either adds to or subtracts from this available heat.

### ■ Rerating of Thermal-Magnetic Circuit Breakers for Ambient Conditions

Square D® thermal-magnetic circuit breakers are to be applied in ambient temperatures within a range of -10° C to +60° C. These rerating guidelines should be followed:

1. At ambient temperatures between 25° C and 40° C, no rerating is necessary.
2. At ambient temperatures between -10° C and 24° C, thermal-magnetic circuit breakers carry more than their continuous current rating without tripping. Wire and equipment damage can result if they are not in the same low ambient environment as the circuit breaker.

If closer protection of the equipment and wire is required, the increased current carrying capacity of the circuit breaker at the lower ambient temperature should be taken into consideration.

3. At ambient temperatures between 41° C and 60° C thermal-magnetic circuit breakers carry less than their continuous current rating and must be carefully selected to prevent nuisance tripping.

The following procedure is used to determine the continuous current carrying capacity of a thermal-magnetic circuit breaker at ambient temperature other than 40° C (see data bulletin *Determining Current Carrying Capacity in Special Applications* for more information):

1. Refer to the ambient rerating curves for the circuit breaker type.
2. Select the curve for the specific amperage rating of the circuit breaker involved. Note in the figure, below, that the curve crosses the 40° C ambient temperature line at the circuit breaker's UL Listed continuous current rating (handle rating).
3. Follow this curve to the ambient temperature in which the circuit breaker is to be installed.
4. Read the continuous current carrying capacity at this left axis point.
5. Apply any other applicable factors, such as 80% loading per the NEC.

Figure 8: LA Circuit Breaker Ambient Rerating Curves

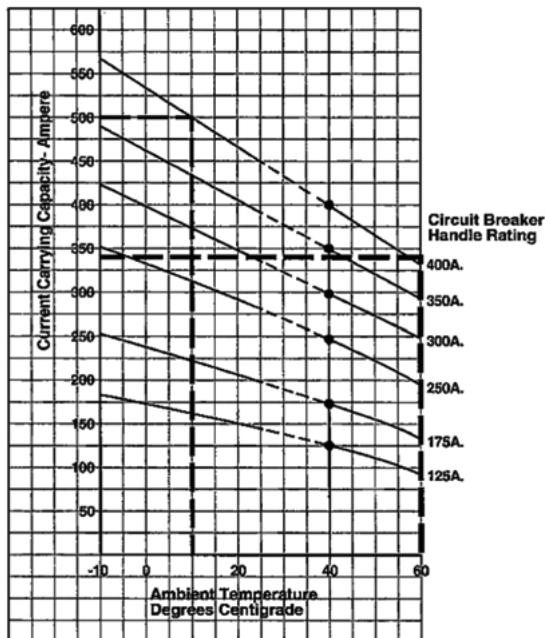

For example, this figure shows the ambient rerating curves for the LA thermal-magnetic circuit breaker. Determine the continuous current carrying capacity of a 400 ampere LA circuit breaker applied at 40° C by finding 40 on the horizontal axis and reading up to the 400 ampere curve. The circuit breaker carries 400A, which is its rated capacity. If the circuit breaker is used on a continuous load (3 hours or more), Paragraph 220-10b of the NEC requires that loading not exceed 80% of the rating (400 ampere x .80 = 320 ampere).

# Thermal-Magnetic / Magnetic Only Molded Case Circuit Breakers Introduction

## ■ Frequency Rating

The standard rated frequency for circuit breakers is 60 Hz, but Square D® circuit breakers can be applied on 50 Hz systems without thermal or magnetic rerating. Other frequencies can affect the thermal, magnetic and short circuit tripping characteristics of circuit breakers.

Applying thermal-magnetic circuit breakers at frequencies above 50/60 Hz requires special consideration of the effects of high frequency on circuit breaker tripping characteristics. Thermal and magnetic operations must be treated separately.

## ■ Thermal Tripping Performance

At frequencies below 60 Hz, the thermal rerating of thermal-magnetic circuit breakers is negligible. However, at frequencies above 60 Hz, thermal rerating is required. High frequency operation causes abnormal heat rise in the current carrying parts because of the skin effect. One of the most common frequency applications is at 400 Hz.

For example, when applying a 200 ampere KA circuit breaker on a 400 Hz system, the circuit breaker's current carrying capacity is as follows:

- Non-continuous loads (less than three hours): The KA circuit breaker may be applied at .92 of its rating, or 184 ampere.
- Continuous loads (3 hours or more): Paragraph 220-10b of the NEC requires that circuit breaker's loading does not exceed 80% of its rating when used for continuous loads. (Unless the circuit breaker is rated for operation at 100% of its rating). Therefore, the current carrying capacity of a 200 ampere KA circuit breaker operating under continuous load at 400 Hz would be  $200 \times .92 \times .80 = 147$  ampere.

**Figure 9: 400 Hz Thermal Rerating Multiplier**

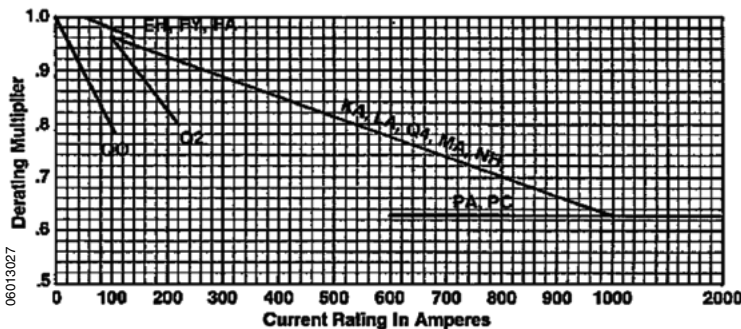

At frequencies above 60 Hz, the interrupting capacity of thermal-magnetic circuit breakers is less than the 60 Hz interrupting capacity. Unless specifically marked on 400 Hz systems, the interrupting capacity of Square D® circuit breakers is reduced to 1/10th of the 60 Hz interrupting capacity.

## ■ Magnetic Tripping Performance

**Figure 10: 60 Hz Current Multipliers**

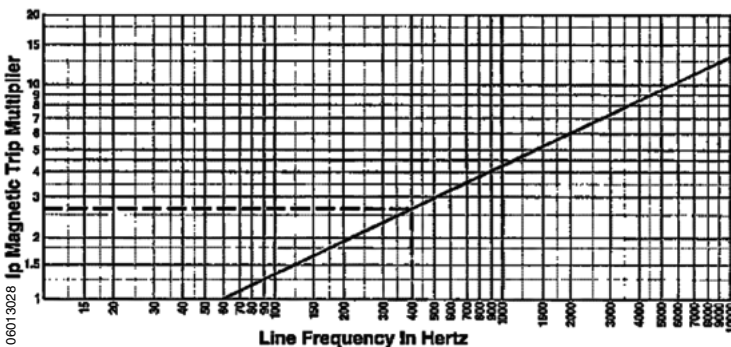

At frequencies above 60 Hz, more current is necessary to magnetically trip a circuit breaker than at 60 Hz. The figure below shows the multipliers of 60 Hz current that it takes to magnetically trip a circuit breaker when applied at various frequencies. For example, at 60 Hz it takes 1000 amperes to magnetically trip a 200 ampere KA circuit breaker at its low setting. At 400 Hz it takes 2600 amperes (2.6 multiplier) to magnetically trip the same circuit breaker.

# Thermal-Magnetic / Magnetic Only Molded Case Circuit Breakers

## Introduction

### ■ Rerating for Direct Current

Trip curves provide complete time-current characteristics of circuit breakers when applied on ac systems only. Thermal-magnetic circuit breakers (1000 ampere frame or less) on dc systems retain their thermal tripping characteristics, but a multiplier must be applied to the ac magnetic trip level to determine an equivalent dc trip level.

Below is a list of multipliers for the dc magnetic trip level of each type of thermal-magnetic circuit breaker:

**Table 7: Rerating Multipliers for Direct Current**

Circuit Breaker	Magnetic Trip Level Multiplier
FA/FH/FC	1.15
KA/KH/KC	Hi Setting 1.15 Lo Setting 1.3
LA/LH	Hi Setting 1.2 Lo Setting 1.3
MA/MH	Hi Setting 1.1 Lo Setting 1.2

For example, the equivalent dc magnetic trip levels for a 200 ampere KA circuit breaker would be:

ac Hi Setting = 2000 ampere + 20%

dc Hi Setting = 2000 ampere x 1.15 = 2300 ampere + 20%

ac Lo Setting = 1000 ampere + 25%

dc Lo Setting = 1000 ampere x 1.3 = 1300 ampere + 25%

### ■ UL Listed 500 Vdc Rated Circuit Breakers

Square D has UL listed dc thermal-magnetic circuit breakers specifically designed for use on ungrounded dc systems having a maximum short circuit (loaded) voltage of 500 Vdc or a maximum floating (unloaded) voltage of 600 Vdc.

This UL Listed dc rating is available on FH, KH, LH, MH and PA molded case circuit breakers. Specific time current characteristic tripping curves are available for these applications.

## Return and Exchange Policy

Molded case circuit breakers are factory sealed and no internal inspection or maintenance is required under normal conditions. **Important: DO NOT OPEN THE SEALED CASE.** Opening of the sealed case voids the UL label and the Square D® warranty.

All damaged or used circuit breakers should be replaced as a unit and returned to the factory for inspection. Upon receipt of the circuit breaker, Square D performs a thorough inspection of the circuit breaker and issues a test report (on request). Unused circuit breakers and circuit breakers returned for inspection must be returned as instructed by the local Square D sales office.

Circuit breakers sent to the factory for inspection or testing are not returned. Square D offers a new circuit breaker and allows a credit for the circuit breaker that was returned. Price and credit allowances for all replacements of molded case circuit breakers and trip units are determined by Class, as follows.

### ■ Class I

New circuit breakers that have been broken by handling or assembling, by other than Square D, or in transit and have not been in service.

#### □ Allowance

A replacement circuit breaker is furnished and billed at list price minus the regular discount. When the circuit breaker in need of repair is returned, a credit allowance (42% of the billing price minus any transportation paid by Square D®) is issued against the invoice of the replacing order.

# Thermal-Magnetic / Magnetic Only Molded Case Circuit Breakers

## Introduction

### ■ Class II

New circuit breakers that meet factory inspection standards and are interchangeable electrically and physically with standard units of current manufacture.

#### □ Allowance

A replacement circuit breaker is furnished at the list price minus the regular discount. When the unused circuit breaker is returned, a credit (in the amount of the billing price minus 20% restocking charge and any transportation paid by Square D) is issued.

### ■ Class III

Inoperative circuit breakers.

#### □ Allowance

A replacement circuit breaker is furnished at the list price minus the regular discount. Upon return of the circuit breaker claimed inoperative, full credit is issued on the basis of the replacement cost plus any transportation costs paid by the customer.

Examination by Square D must substantiate the claimed inoperative nature of the material returned.

### ■ Class IV

Exchange of permanent trip circuit breakers (KA, LA, MA or NA) furnished in lieu of circuit breakers specified with interchangeable trip. These circuit breakers can be identified by a label stating they are subject to this exchange policy.

#### □ Allowance

A replacement circuit breaker within the same frame size, but of a different trip rating than that exchanged, is furnished at the lowest recognized competitive list price for a trip unit of the same frame size and trip rating minus the regular discount. This exchange arrangement requires that the replaced circuit breaker be returned to Square D.

## Catalog Numbers

Square D circuit breakers are ordered by a catalog number that includes the breaker family, description, poles, voltage rating, amperage rating and suffix.

The table below shows a typical catalog number broken down by components. For example, FAL36050V2100, can be broken down as follows:

FA	100 ampere frame circuit breaker
L	Circuit breaker with lugs on both ends
3	Number of poles
6	Voltage rating
050	Continuous current amperage rating (handle rating)
V and 2100	V indicates the Visi-Blade® feature and the 2100 indicates a factory installed contact alarm. These two components are the suffix

# Thermal-Magnetic / Magnetic Only Molded Case Circuit Breakers

## Introduction

**Table 8: Breakdown of Typical Catalog Number**

	FA	L	3	6	050	V	2100
<p><b>Breaker Family</b></p> <p>FY - 30 Ampere Frame</p> <p>FA - 100 Ampere Frame</p> <p>KA - 250 Ampere Frame</p> <p>LA - 400 Ampere Frame</p> <p>MA 1000 Ampere Frame</p> <p>NA - 1200 Ampere Frame</p>							
<p><b>NOTE:</b></p> <p>"A" is replaced by letter "H" for High Interrupting</p> <p>"A" is replaced by letter "C" for Extra High Interrupting</p> <p>"A" is replaced by letter "I" for Current Limiting. (FA, KA, LA circuit breakers only)</p>							
<p><b>Description</b></p> <p>NO LETTER - (I-Line<sup>®</sup>) Plug-on Breaker</p> <p>B - (I-Line) Bolt-on Breaker (400 ampere frame maximum)</p> <p>F - Terminal Pads Only (No Lugs)</p> <p>L - Lugs on Both Ends (Merchandised - Universal Breaker)</p> <p>P - Lugs OFF End Only</p> <p>R - Plug-on Breaker (I-Line Type DO with Plug-on Line and Load connectors)</p>							
<p><b>Poles</b></p> <p>1 - 1-Pole</p> <p>2 - 2-Pole</p> <p>3 - 3-Pole</p>							
<p><b>Voltage Rating</b></p> <p>2 - 240 Vac</p> <p>4 - 480 Vac</p> <p>6 - 600 Vac</p>							
<p><b>Ampere Rating</b></p> <p>015-090 - 15-90 Ampere Rating</p> <p>100-900 - 100-900 Ampere Rating</p> <p>1000-1200 - 1000-1200 Ampere Rating</p> <p>000 or 0000 - Molded Case Switch</p> <p>000X or 000XX - Molded Case Switch</p>							
<p><b>Suffix</b></p> <p>The suffix indicates a special feature of the circuit breaker.</p> <p>A, B, C - indicated I-Line Phase Connections</p> <p>CV - Indicates Visi-Blade<sup>®</sup></p> <p>M - Indicates Automatic Molded Case Switch</p> <p>XXM - Indicated Instantaneous Trip Only (Mag-Gard<sup>®</sup>) (i.e., 18M is 300-1100 ampere adjustable trip range)</p> <p>XXT - Indicates adjustable magnetic trip with responsive thermal (mining breakers)</p> <p>G - Indicates Ground Fault Shunt Trip accessory</p> <p>XXXX - i.e., 2100 Indicates a factory installed accessory</p>							

# Thermal-Magnetic / Magnetic Only Molded Case Circuit Breakers Introduction

**Table 9: Powerpack® Q-frame Catalog Numbering System\***

Number Segment	Character	Description	Q	B	L	3	2	250	4▲	L W■	
Circuit Breaker Family	Q										
Circuit Breaker Type (Interrupting Rating)	B	10 kA									
	D	25 kA									
	G	65 kA									
	J	100 kA									
Connection Type	A	I-Line®									
	E	Bolt-on I-Line									
	F	No lugs (Bus Connection)									
	L	Lugs on both ends									
	M	Lugs on ON (I) end only									
	P	Lugs on OFF (O) end only									
Poles	2	2-pole									
	3	3-pole									
240 Volts Only	2										
Continuous Current Rating (Amperes)	70										
	80										
	90										
	100										
	110										
	125										
	150										
	175										
	200										
	225										
	250										
		000 S 22 = Switch (QB only)									
	I-Line Phasing	2-pole	1 = AB								
2 = AC											
3 = BA											
4 = BC											
5 = CA											
6 = CB											
3-pole		None = ABC									
		6 = CBA									
Special Ambient		C	A = 50 C								
Control Taps		L	U = Control taps applied to ON (I) end								
	V = Control taps applied to OFF (O) end										
	W = Control taps applied to both ends										
Termination Options	T	M = Lugs applied to OFF (O) end; studs with nuts and washers threaded onto ON (I) end									
		N = Lugs applied to ON (I) end; studs applied to OFF (O) end (nuts/washers in bag, supplied)									
		P = Studs applied to ON (I) end; Lugs applied to OFF (O) end (nuts/washers in bag, supplied)									
		S = Studs on BOTH ends (nuts/ washers in bag, supplied)									
Special Features	Y	D = Calibration test report supplied									
		F = Fungus treatment									
		P = Handle Padlock Attachment, ON (I) or OFF (O) position									
		Q = Handle Padlock Attachment, OFF (O) position only									

\* See Class 611, 612, 613, and 734 catalogs for other Powerpack and Masterpack® circuit breakers.

▲ May be collapsed if none.

■ May be collapsed if none. May be multiple options.

# Thermal-Magnetic / Magnetic Only Molded Case Circuit Breakers

## Introduction

**Table 10: Powerpact® H-frame Catalog Numbering System\***

Number Segment	Character	Description	H	L	L	3	6	150	T <sup>▲</sup>	■
Circuit Breaker Family	H									
Circuit Breaker Type (Interrupting Rating)	D	25 kA								
	G	65 kA								
	J	100 kA								
	L	125 kA								
Connection Type	A	I-Line®								
	D	Drawout								
	F	Bus Bar								
	K	Reverse I-Line								
	L	Lugs (Line/Load Side)								
	M	Lugs (Line Side)								
	N	Plug-in								
	P	Lugs (Load Side)								
	S	Rear Connected								
Poles	2	2-pole								
	3	3-pole								
Voltage	6	600 Vac								
	150	15–150 ampere								
Continuous Current Rating (Amperes)	000	Switch								
	—	Standard Fixed Trip Unit (suitable for reverse connection)								
Trip Unit	F06	60 Ampere H-frame Only (no trip unit)								
	F15	150 Ampere H-frame Only (no trip unit)								
	T	Complete Circuit Breaker (frame and removable trip unit)								
	S15	Molded Case Switch 150 Ampere H-frame Automatic Switch								
	C	100% Continuous Current Rating								
<b>Accessory Suffix Codes★</b>										

★ See Powerpact H- and J-frame catalog, Class 611, for more information. Also, see Class 612, 613, and 734 catalogs for other Powerpact and Masterpact® circuit breakers.

▲ May be collapsed if none.

■ May be collapsed if none. May be multiple options.

# Thermal-Magnetic / Magnetic Only Molded Case Circuit Breakers Introduction

**Table 11: Powerpact® J-frame Catalog Numbering System★**

Number Segment	Character	Description	J	L	L	3	6	250	T▲	■
Circuit Breaker Family	J									
Circuit Breaker Type (Interrupting Rating)	D	25 kA								
	G	65 kA								
	J	100 kA								
	L	125 kA								
Connection Type	A	I-Line®								
	D	Drawout								
	F	Bus Bar								
	K	Reverse I-Line								
	L	Lugs (Line/Load Side)								
	M	Lugs (Line Side)								
	N	Plug-in								
	P	Lugs (Load Side)								
	S	Rear Connected								
Poles	2	2-pole								
	3	3-pole								
Voltage	6	600 Vac								
Continuous Current Rating (Amperes)	150	150–250 ampere								
	000	Switch								
Trip Unit	—	Standard Fixed Trip Unit (suitable for reverse connection)								
	F25	250 Ampere J-frame Only (no trip unit)								
	T	Complete Circuit Breaker (frame and removable trip unit)								
	S17	Molded Case Switch 175 Ampere J-frame Automatic Switch								
	S25	Molded Case Switch 250 Ampere J-frame Automatic Switch								
	C	100% Continuous Current Rating								
Accessory Suffix Codes★										

★ See Powerpact H- and J-frame catalog, Class 611, for more information. Also, see Class 612, 613, and 734 catalogs for other Powerpact and Masterpact® circuit breakers.

▲ May be collapsed if none.

■ May be collapsed if none. May be multiple options.

# Thermal-Magnetic / Magnetic Only Molded Case Circuit Breakers

## Introduction

**Table 12: Powerpact® M-frame Catalog Numbering System\***

Number Segment	Character	Description	M	G	A	3	6	800	6 <sup>▲</sup>	AB <sup>■</sup>
Circuit Breaker Family	M									
Circuit Breaker Type (Interrupting Rating)	G	35 kA @ 480 Volts								
	J	65 kA @ 480 Volts								
Connection Type	A	I-Line®								
	F	No lugs (Bus Connection)								
	L	Lugs on both ends								
	M	Lugs on ON (I) end only								
	P	Lugs on OFF (O) end only								
Poles	2	2-pole								
	3	3-pole								
Voltage	6	600 Vac								
Continuous Current Rating (Amperes)	300									
	350									
	400									
	450									
	500									
	600									
	700									
	800									
I-Line Phasing	2-pole	1 = AB								
		2 = AC								
		3 = BA								
		4 = BC								
		5 = CA								
		6 = CB								
	3-pole	None = ABC								
		6 = CBA								
Accessory Suffix Codes*										

\* See *M-frame, P-frame, R-frame and NS630b-NS3200 Electronic Trip Circuit Breakers Catalog* for more information. Also, see Class 611, 612, 613, and 734 catalogs for other Powerpact and Masterpact® circuit breakers.

▲ May be collapsed if none.

■ May be collapsed if none. May be multiple options.

# Thermal-Magnetic / Magnetic Only Molded Case Circuit Breakers 100 Ampere Frame

## 100 AMPERE FRAME

This section provides specific information on Square D® 100 ampere frame thermal-magnetic molded case circuit breakers. For more information, see the Introduction in this catalog.

### Description

**Table 13: Description of 100 Ampere Frame Circuit Breakers**

Circuit Breaker	Description
HD, HG, HJ, HL	15-150 ampere, 600 Vac, 50/60 Hz 250 Vdc, 2-, 3-pole.
FA/FH	15-100 ampere, 600 Vac, 50/60 Hz, 250 Vdc, 1-, 2- and 3-pole.
FC	15-100 ampere, 480 Vac, 50/60 Hz, 2- and 3-pole
FI	20-100 ampere, 600 Vac 50/60 Hz, 2- and 3-pole
FY	15-30 ampere, 277 Vac, 50/60 Hz, 1-pole

### Applications

- FI current limiting circuit breakers are used for electrical systems where high fault currents can occur.
- FA/FH, FC, and FI circuit breakers are used in industrial enclosures, panelboards, switchboards, busway plug-in units, combination starters, or motor control centers.
- FY thermal-magnetic circuit breakers are used in I-Line® panelboards and switchboards.

**Table 14: 100 Ampere Frame Interrupting Ratings**

Catalog Number Prefix		No. of Poles	Cont. Ampere Rating	UL Listed Interrupting Rating (kA)									Federal Specs. W-C-375B/GEN	IEC 60947-2 Icu/Ics (kA) AC Voltage
				AC Volts - RMS Symmetrical Amperes					DC Volts					
Unit Mount	I-Line			120	240	480Y/277	480	600	125	250	500		415/240	
	FY	1	15-30	18	14	14	—	—	—	—	—	11a, 13b	10/2.5	
FAL 240 Vac	FA 240 Vac	1	15-100	10	—	—	—	—	5	—	—	11a	10/2.5	
		2	15-100	10	10	—	—	—	5	5	—	11b, 12b		
		3	15-100	10	10	—	—	—	5	5	—	11b, 12b		
FAL 480 Vac	FA 480 Vac	1	15-100	25	18	18	—	—	10	—	—	11a, 12a, 13a	10/2.5	
		2	15-100	25	25	18	18	—	10	10	—	13b		
		3	15-100	25	25	18	18	—	10	10	—	13b		
FAL 600 Vac	FA 600 Vac	2	15-100	25	25	18	18	14	10	10	—	18a	10/2.5	
		3	15-100	25	25	18	18	14	10	10	—	18a		
FHL*	FH*	1	15-30	65	65	65	—	—	10	—	—	13a	10/2.5	
		1	35-100	65	25	25	—	—	10	10	—	13a		
		2, 3	15-100	65	65	25	25	18	50	50	—	22a		
FHL-DC <sup>▲</sup>	—	3	—	—	—	—	—	—	—	—	20K	—	—	
FCL	FC	2, 3	20-100	100	100	65	65	—	—	—	—	22a	10/2.5	
FIL	FI	2, 3	20-100	200	200	200	200	100	—	—	—	16a	6/1.5	

\* Separate UL rating available for 240 Vac and 480 Vac grounded B single phase systems. Breakers must be ordered with 5861 suffix.

▲ UL Listed 500 Vdc rating for use on ungrounded systems. Must be connected 3 poles in series. Consult your local Square D sales office for additional information 1-888-Square D.

*NOTE: For IEC 60947-2 rated S-line ratings, not UL listed, see Supplemental Digest.*

# Thermal-Magnetic / Magnetic Only Molded Case Circuit Breakers 100 Ampere Frame

Table 15: 150 Ampere Powerpack® H-frame Molded Case Circuit Breakers\*

Catalog Number Prefix		No. of Poles	Cont. Ampere Rating	UL Listed Interrupting Rating (kA)								Federal Specs. W-C-375B/GEN	IEC 60947-2 Icu/Ics (kA) AC Voltage	
				AC Volts - RMS Symmetrical Amperes					DC Volts				415	240
Unit Mount	I-Line®			120	240	480Y/277	480	600	125	250	500			
HD	HDA	2, 3	15-150	25	25	18	18	14	20	20	TBD	19a	18/4	25/6
HG	HGA			65	65	35	35	18	20	20	TBD	22a	35/8	65/16
HJ	HJA			100	100	65	65	25	20	20	TBD	23a	65/16	100/25
HL	HLA			125	125	100	100	50	20	20	TBD	25a	100/25	125/31

\* See Powerpack H- and J-frame catalog, Class 611, for more information. Also, see Class 612, 613, and 734 catalogs for other Powerpack and Masterpack® circuit breakers.

## Selection Data

Table 16: 100 Ampere Frame Unit Mount Circuit Breakers

Ampere Rating	AC Magnetic Trip Settings Amperes	One Pole Catalog No.	Two Pole Catalog No.	Three Pole Catalog No.	Standard Lug Kit Wire Range
---------------	-----------------------------------	----------------------	----------------------	------------------------	-----------------------------

### FAL Standard Interrupting

	Hold	Trip	120 Vac	240 Vac	240 Vac	
15	275	600	FAL12015	FAL22015	FAL32015	AL50FA #14-#4 Cu or #12-#4 Al
20	275	600	FAL12020	FAL22020	FAL33020	
25	275	600	FAL12025	FAL22025	FAL32025	
30	275	600	FAL12030	FAL22030	FAL32030	
35	400	850	FAL12035	FAL22035	FAL32035	
40	400	850	FAL12040	FAL22040	FAL32040	AL100FA #14-#1/0 Cu or #12-#1/0 Al
45	400	850	FAL12045	FAL22045	FAL32045	
50	400	850	FAL12050	FAL22050	FAL32050	
60	830	1450	FAL12060	FAL22060	FAL32060	
70	800	1450	FAL12070	FAL22070	FAL32070	
80	800	1450	FAL12080	FAL22080	FAL32080	
90	900	1700	FAL12090	FAL22090	FAL32090	
100	900	1700	FAL12100	FAL22100	FAL32100	

### FAL Standard Interrupting

	Hold	Trip	277 Vac/125 Vdc	480 Vac/250 Vdc	480 Vac/250 Vdc	
15	275	600	FAL14015	FAL24015	FAL34015	AL50FA #14-#4 Cu or #12-#4 Al
20	275	600	FAL14020	FAL24020	FAL34020	
25	275	600	FAL14025	FAL24025	FAL34025	
30	275	600	FAL14030	FAL24030	FAL34030	
35	400	850	FAL14035	FAL24035	FAL34035	AL100FA #14-#1/0 Cu or #12-#1/0 Al
40	400	850	FAL14040	FAL24040	FAL34040	
45	400	850	FAL14045	FAL24045	FAL34045	
50	400	850	FAL14050	FAL24050	FAL34050	
60	800	1450	FAL14060	FAL24060	FAL34060	
70	800	1450	FAL14070	FAL24070	FAL34070	
80	800	1450	FAL14080	FAL24080	FAL34080	
90	900	1700	FAL14090	FAL24090	FAL34090	
100	900	1700	FAL14100	FAL24100	FAL34100	

Continued on next page

06013029



FAL One-pole  
15-100 Ampere

06013030



FAL/FHL Two-pole  
15-100 Ampere

# Thermal-Magnetic / Magnetic Only Molded Case Circuit Breakers 100 Ampere Frame

**Table 16: 100 Ampere Frame Unit Mount Circuit Breakers** (continued)

Ampere Rating	AC Magnetic Trip Settings Amperes	One Pole Catalog No.	Two Pole Catalog No.	Three Pole Catalog No.	Standard Lug Kit Wire Range
<b>FAL Standard Interrupting</b>					
	Hold	Trip		600 Vac/250 Vdc	600 Vac/250 Vdc
15	275	600	—	FAL26015	FAL36015
20	275	600	—	FAL26020	FAL36020
25	275	600	—	FAL26025	FAL36025
30	275	600	—	FAL26030	FAL36030
35	400	850	—	FAL26035	FAL36035
40	400	850	—	FAL26040	FAL36040
45	400	850	—	FAL26045	FAL36045
50	400	850	—	FAL26050	FAL36050
60	800	1450	—	FAL26060	FAL36060
70	800	1450	—	FAL26070	FAL36070
80	800	1450	—	FAL26080	FAL36080
90	900	1700	—	FAL26090	FAL36090
100	900	1700	—	FAL26100	FAL36100
<b>FHL High Interrupting</b>					
	Hold	Trip	277 Vac/125 Vdc	600 Vac/250 Vdc	600 Vac/250 Vdc
15	275	600	FHL16015	FHL26015	FHL36015
20	275	600	FHL16020	FHL26020	FHL36020
25	275	600	FHL16025	FHL26025	FHL36025
30	275	600	FHL16030	FHL26030	FHL36030
35	400	850	FHL16035	FHL26035	FHL36035
40	400	850	FHL16040	FHL26040	FHL36040
45	400	850	FHL16045	FHL26045	FHL36045
50	400	850	FHL16050	FHL26050	FHL36050
60	800	1450	FHL16060	FHL26060	FHL36060
70	800	1450	FHL16070	FHL26070	FHL36070
80	800	1450	FHL16080	FHL26080	FHL36080
90	900	1700	FHL16090	FHL26090	FHL36090
100	900	1700	FHL16100	FHL26100	FHL36100
<b>FCL Extra High Interrupting</b>					
	Hold	Trip		480 Vac*	480 Vac
15	275	600	—	FCL24015	FCL34015
20	275	600	—	FCL24020	FCL34020
25	275	600	—	FCL24025	FCL34025
30	275	600	—	FCL24030	FCL34030
35	400	850	—	FCL24035	FCL34035
40	400	850	—	FCL24040	FCL34040
45	400	850	—	FCL24045	FCL34045
50	400	850	—	FCL24050	FCL34050
60	800	1450	—	FCL24060	FCL34060
70	800	1450	—	FCL24070	FCL34070
80	800	1450	—	FCL24080	FCL34080
90	900	1700	—	FCL24090	FCL34090
100	900	1700	—	FCL24100	FCL34100
<b>FIL I-Limiter® Current Limiting</b>					
	Hold	Trip		600 Vac	600 Vac
20	275	600	—	FIL26020	FIL36020
30	275	600	—	FIL26030	FIL36030



**FAL/FHL/FCL Three-pole  
15–100 Ampere**



**FIL Two- and Three-pole  
20–100 Ampere**

Continued on next page

# Thermal-Magnetic / Magnetic Only Molded Case Circuit Breakers 100 Ampere Frame

**Table 16: 100 Ampere Frame Unit Mount Circuit Breakers (continued)**

Ampere Rating	AC Magnetic Trip Settings Amperes		One Pole Catalog No.	Two Pole Catalog No.	Three Pole Catalog No.	Standard Lug Kit Wire Range
40	400	850	—	FIL26040	FIL36040	AL100FA 1-#14-#1/0 Cu or 1-#12-#1/0 Al
50	400	850	—	FIL26050	FIL36050	
60	800	1700	—	FIL26060	FIL36060	
70	800	1700	—	FIL26070	FIL36070	
80	800	1700	—	FIL26080	FIL36080	
90	800	1700	—	FIL26090	FIL36090	
100	800	1700	—	FIL26100	FIL36100	

★ FCL 2-pole circuit breaker built using 3-pole module.

**Table 17: 100 Ampere Frame I-Line® Circuit Breakers**

Ampere Rating	AC Magnetic Trip Settings Amperes		One Pole★ Catalog No.	Two Pole★ Catalog No.	Three Pole Catalog No.	Standard Lug Kit Wire Range
---------------	-----------------------------------	--	-----------------------	-----------------------	------------------------	-----------------------------

**FA Standard Interrupting**

	Hold	Trip		240 Vac	240 Vac	
15	275	600	—	FA22015( )	FA32015	AL50FA 1-#14-#4 Cu or 1-#12-#4 Al
20	275	600	—	FA22020( )	FA33020	
25	275	600	—	FA22025( )	FA32025	
30	275	600	—	FA22030( )	FA32030	
35	400	850	—	FA22035( )	FA32035	AL100FA 1-#14-#1/0 Cu or 1-#12-#1/0 Al
40	400	850	—	FA22040( )	FA32040	
45	400	850	—	FA22045( )	FA32045	
50	400	850	—	FA22050( )	FA32050	
60	830	1450	—	FA22060( )	FA32060	
70	800	1450	—	FA22070( )	FA32070	
80	800	1450	—	FA22080( )	FA32080	
90	900	1700	—	FA22090( )	FA32090	
100	900	1700	—	FA22100( )	FA32100	

**FA Standard Interrupting**

	Hold	Trip	277 Vac/125 Vdc	480 Vac/250 Vdc	480 Vac/250 Vdc	
15	275	600	FY14015( )▲	FA24015( )	FA34015	AL50FA 1-#14-#4 Cu or 1-#12-#4 Al
20	275	600	FY14020( )▲	FA24020( )	FA34020	
25	275	600	FY14025( )▲	FA24025( )	FA34025	
30	275	600	FY14030( )▲	FA24030( )	FA34030	
35	400	850	FA14035( )■	FA24035( )	FA34035	AL100FA 1-#14-#1/0 Cu or 1-#12-#1/0 Al
40	400	850	FA14040( )■	FA24040( )	FA34040	
45	400	850	FA14045( )■	FA24045( )	FA34045	
50	400	850	FA14050( )■	FA24050( )	FA34050	
60	800	1450	FA14060( )■	FA24060( )	FA34060	
70	800	1450	FA14070( )■	FA24070( )	FA34070	
80	800	1450	FA14080( )■	FA24080( )	FA34080	
90	900	1700	FA14090( )■	FA24090( )	FA34090	
100	900	1700	FA14100( )■	FA24100( )	FA34100	

**FA Standard Interrupting**

	Hold	Trip		600 Vac/250 Vdc	600 Vac/250 Vdc	
15	275	600	—	FA26015( )	FA36015	AL50FA 1-#14-#4 Cu or 1-#12-#4 Al
20	275	600	—	FA26020( )	FA36020	
25	275	600	—	FA26025( )	FA36025	
30	275	600	—	FA26030( )	FA36030	

Continued on next page



FY/ FA/FH One-pole  
1-1/2" Mounting Height



FA/FH Two-pole  
3" Mounting Height

# Thermal-Magnetic / Magnetic Only Molded Case Circuit Breakers 100 Ampere Frame

**Table 17: 100 Ampere Frame I-Line® Circuit Breakers (continued)**

Ampere Rating	AC Magnetic Trip Settings Amperes		One Pole* Catalog No.	Two Pole* Catalog No.	Three Pole Catalog No.	Standard Lug Kit Wire Range
35	400	850	—	FA26035( )	FA36035	AL100FA 1-#14-#1/0 Cu or 1-#12-#1/0 Al
40	400	850	—	FA26040( )	FA36040	
45	400	850	—	FA26045( )	FA36045	
50	400	850	—	FA26050( )	FA36050	
60	800	1450	—	FA26060( )	FA36060	
70	800	1450	—	FA26070( )	FA36070	
80	800	1450	—	FA26080( )	FA36080	
90	900	1700	—	FA26090( )	FA36090	
100	900	1700	—	FA26100( )	FA36100	

**FH High Interrupting**

	Hold	Trip	277 Vac/125 Vdc	600 Vac/250 Vdc	600 Vac/250 Vdc	
15	275	600	FH16015( )	FH26015( )	FH36015	AL50FA 1-#14-#4 Cu or 1-#12-#4 Al
20	275	600	FH16020( )	FH26020( )	FH36020	
25	275	600	FH16025( )	FH26025( )	FH36025	
30	275	600	FH16030( )	FH26030( )	FH36030	
35	400	850	FH16035( )	FH26035( )	FH36035	AL100FA 1-#14-#1/0 Cu or 1-#12-#1/0 Al
40	400	850	FH16040( )	FH26040( )	FH36040	
45	400	850	FH16045( )	FH26045( )	FH36045	
50	400	850	FH16050( )	FH26050( )	FH36050	
60	800	1450	FH16060( )	FH26060( )	FH36060	
70	800	1450	FH16070( )	FH26070( )	FH36070	
80	800	1450	FH16080( )	FH26080( )	FH36080	
90	900	1700	FH16090( )	FH26090( )	FH36090	
100	900	1700	FH16100( )	FH26100( )	FH36100	

**FC Extra High Interrupting**

	Hold	Trip		480 Vac	480 Vac	
15	275	600	—	FC24015( )	FC34015	CU30FA4 1-#14-#10 Cu
20	275	600	—	FC24020( )	FC34020	
25	275	600	—	FC24025( )	FC34025	
30	275	600	—	FC24030( )	FC34030	
35	400	850	—	FC24035( )	FC34035	AL100FA4 1-#14-#3 Cu or 1-#12-#1 Al
40	400	850	—	FC24040( )	FC34040	
45	400	850	—	FC24045( )	FC34045	
50	400	850	—	FC24050( )	FC34050	
60	800	1450	—	FC24060( )	FC34060	
70	800	1450	—	FC24070( )	FC34070	
80	800	1450	—	FC24080( )	FC34080	
90	900	1700	—	FC24090( )	FC34090	
100	900	1700	—	FC24100( )	FC34100	

**FI I-Limiter® Current Limiting**

	Hold	Trip		600 Vac	600 Vac	
20	275	600	—	FI26020( )	FI36020	AL50FA 1-#14-#4 Cu or 1-#12-#4 Al
30	275	600	—	FI26030( )	FI36030	

Continued on next page



**FA/FH Three-pole  
FC Two- and Three-pole  
4-1/2" Mounting Height**



**FI Two- and Three-pole  
4-1/2" Mounting Height**

# Thermal-Magnetic / Magnetic Only Molded Case Circuit Breakers

## 100 Ampere Frame

**Table 17: 100 Ampere Frame I-Line® Circuit Breakers (continued)**

Ampere Rating	AC Magnetic Trip Settings Amperes		One Pole★ Catalog No.	Two Pole★ Catalog No.	Three Pole Catalog No.	Standard Lug Kit Wire Range
40	400	850	—	FI26040( )	FI36040	AL100FA 1-#14-#1/0 Cu or 1-#12-#1/0 Al
50	400	850	—	FI26050( )	FI36050	
60	800	1700	—	FI26060( )	FI36060	
70	800	1700	—	FI26070( )	FI36070	
80	800	1700	—	FI26080( )	FI36080	
90	800	1700	—	FI26090( )	FI36090	
100	800	1700	—	FI26100( )	FI36100	

★ 1- and 2-pole circuit breaker catalog numbers are completed by adding the required phase connection letters as a suffix to the catalog number.

▲ Rated 277 Vac 15 and 20 ampere FY breakers are rated for switching duty (SWD). 15, 20, 25, and 30 ampere FA I-Line® breakers are also available (no SWD rating).

■ Rated 277 Vac, 125 Vdc except FY, which has no dc rating. 15–30 ampere breakers suitable for use with 60°C or 75°C conductors. 35-100 ampere breakers are suitable for use with 75°C conductors.

### Powerpact® Selection Data

For Powerpact selection information see Class 611, 612, 613, and 734 catalogs.



H-frame: Class 611

# Thermal-Magnetic / Magnetic Only Molded Case Circuit Breakers 100 Ampere Frame

## Dimensions

Figure 11: FAL, FHL, FCL 100 Ampere Frame

06013035

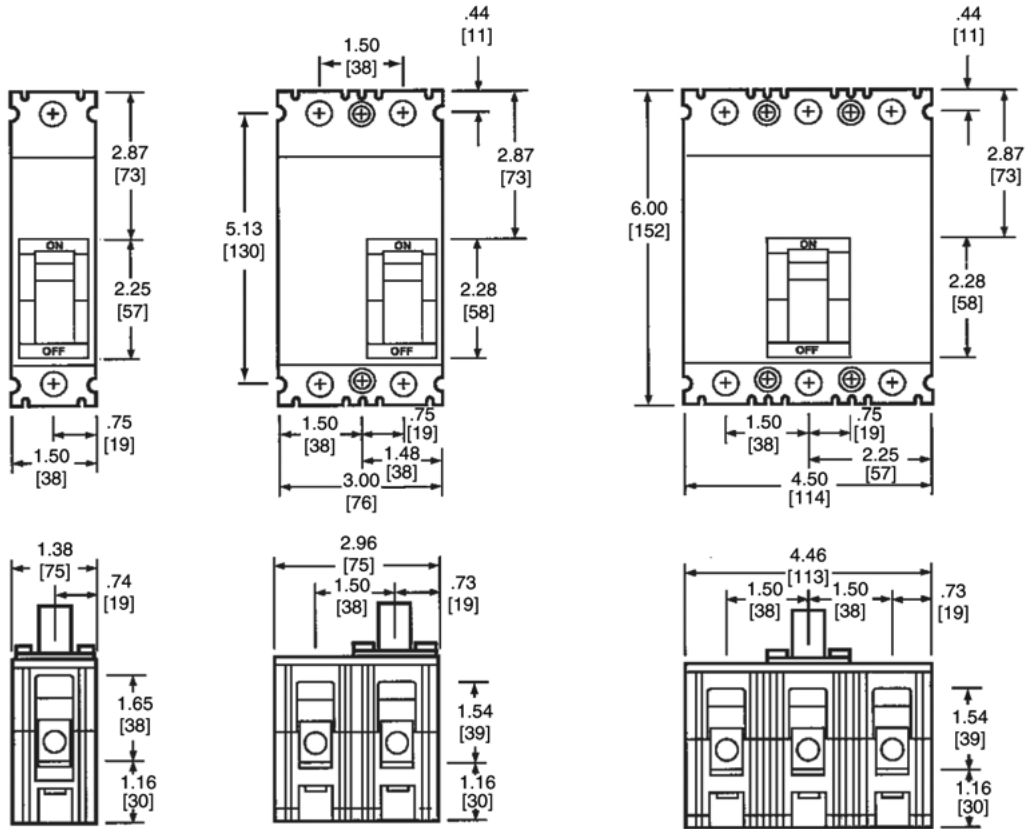

FCL 2-pole circuit breaker dimension is the same as a 3-pole circuit breaker.

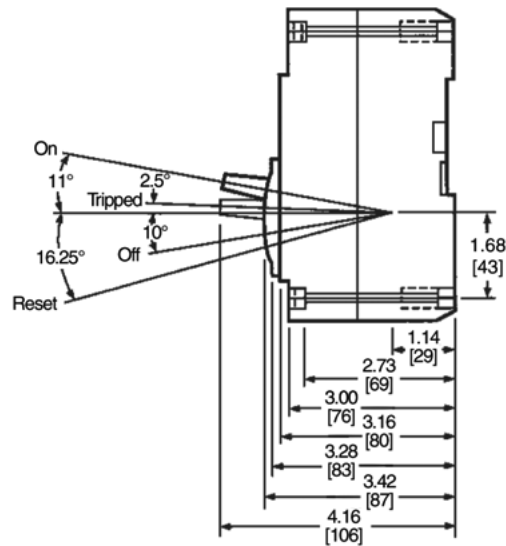

Dimensions: In. [mm]



# Thermal-Magnetic / Magnetic Only Molded Case Circuit Breakers 100 Ampere Frame

## Tripping Curves

06013037

### FA/FH/FC FAMILY MOLDED CASE CIRCUIT BREAKERS CHARACTERISTIC TRIP CURVE NO. 650-1

CIRCUIT BREAKER INFORMATION			
Circuit Breaker Prefix	Continuous Ampere Rating	Maximum AC Voltage	Number of Poles
FA	15-25	240	1 <sup>★</sup> , 2, 3
FA		480	1 <sup>▲</sup> , 2, 3
FC		240	2, 3
FC		480	2, 3
FA		600	2, 3
FA, FH		600	1 <sup>▲</sup> , 2, 3

- ★ 120 Vac maximum
- ▲ 277 Vac maximum

This curve is to be used for application and coordination purposes only. The **EZ-AMP™** overlay feature at the bottom of the page should be used during coordination studies.

All time/current characteristic curve data is based on 40°C ambient cold start. Terminations are made with conductors of appropriate length and ratings.

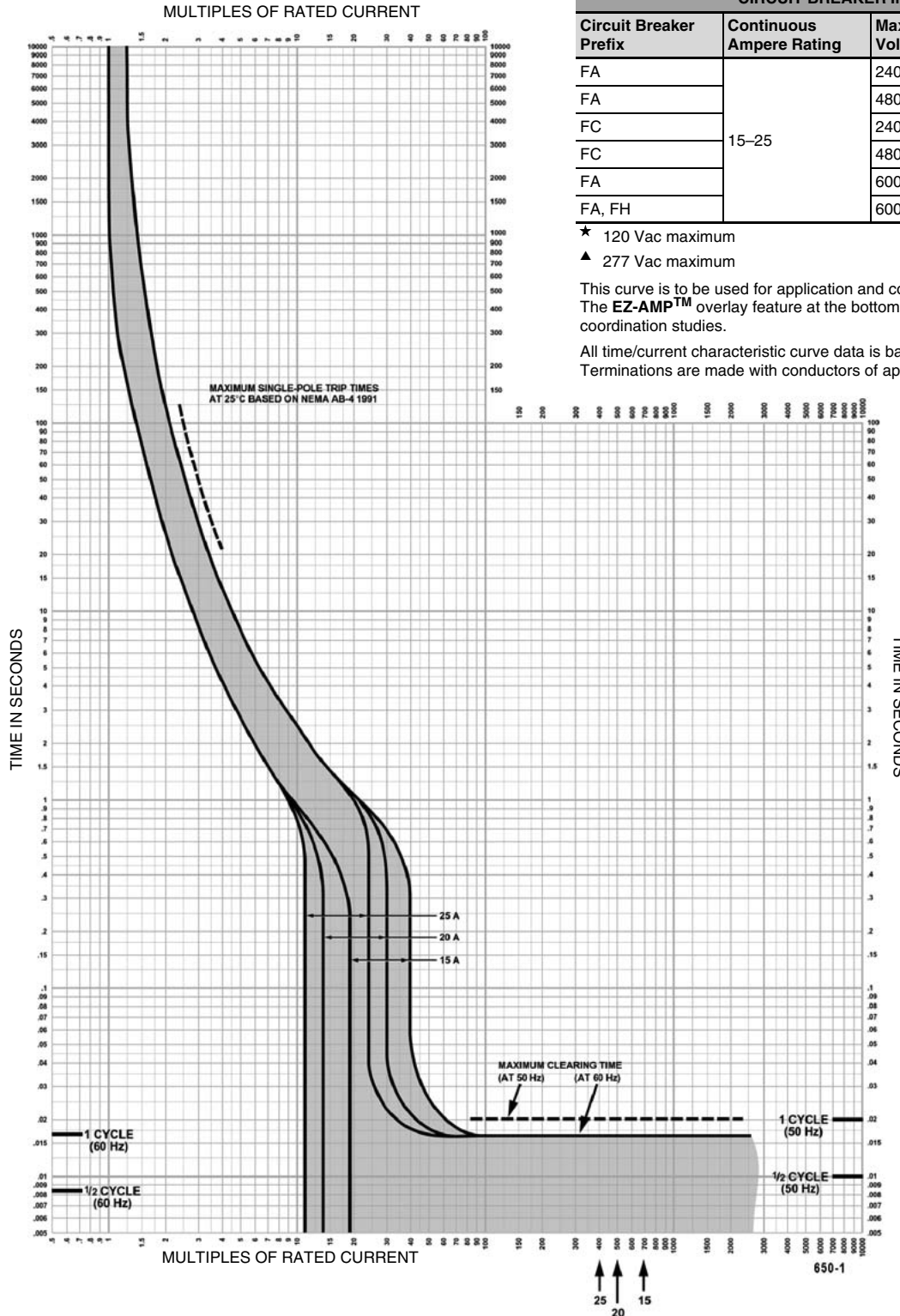

Tripping curves for coordination studies are available upon request.

Curve No. 0650TC0001  
December 2000  
Drawing No. B48095-650-01  
(Replaces 0650TC9001)

# Thermal-Magnetic / Magnetic Only Molded Case Circuit Breakers 100 Ampere Frame

06013038

## FA/FH/FC FAMILY MOLDED CASE CIRCUIT BREAKERS CHARACTERISTIC TRIP CURVE NO. 650-2

CIRCUIT BREAKER INFORMATION			
Circuit Breaker Prefix	Continuous Ampere Rating	Maximum AC Voltage	Number of Poles
FA	30	240	1★, 2, 3
FA		480	1▲, 2, 3
FC		240	2, 3
FC		480	2, 3
FA		600	2, 3
FH		600	1▲, 2, 3

★ 120 Vac maximum

▲ 277 Vac maximum

This curve is to be used for application and coordination purposes only. The **EZ-AMP™** overlay feature at the bottom of the page should be used during coordination studies.

All time/current characteristic curve data is based on 40°C ambient cold start. Terminations are made with conductors of appropriate length and ratings.

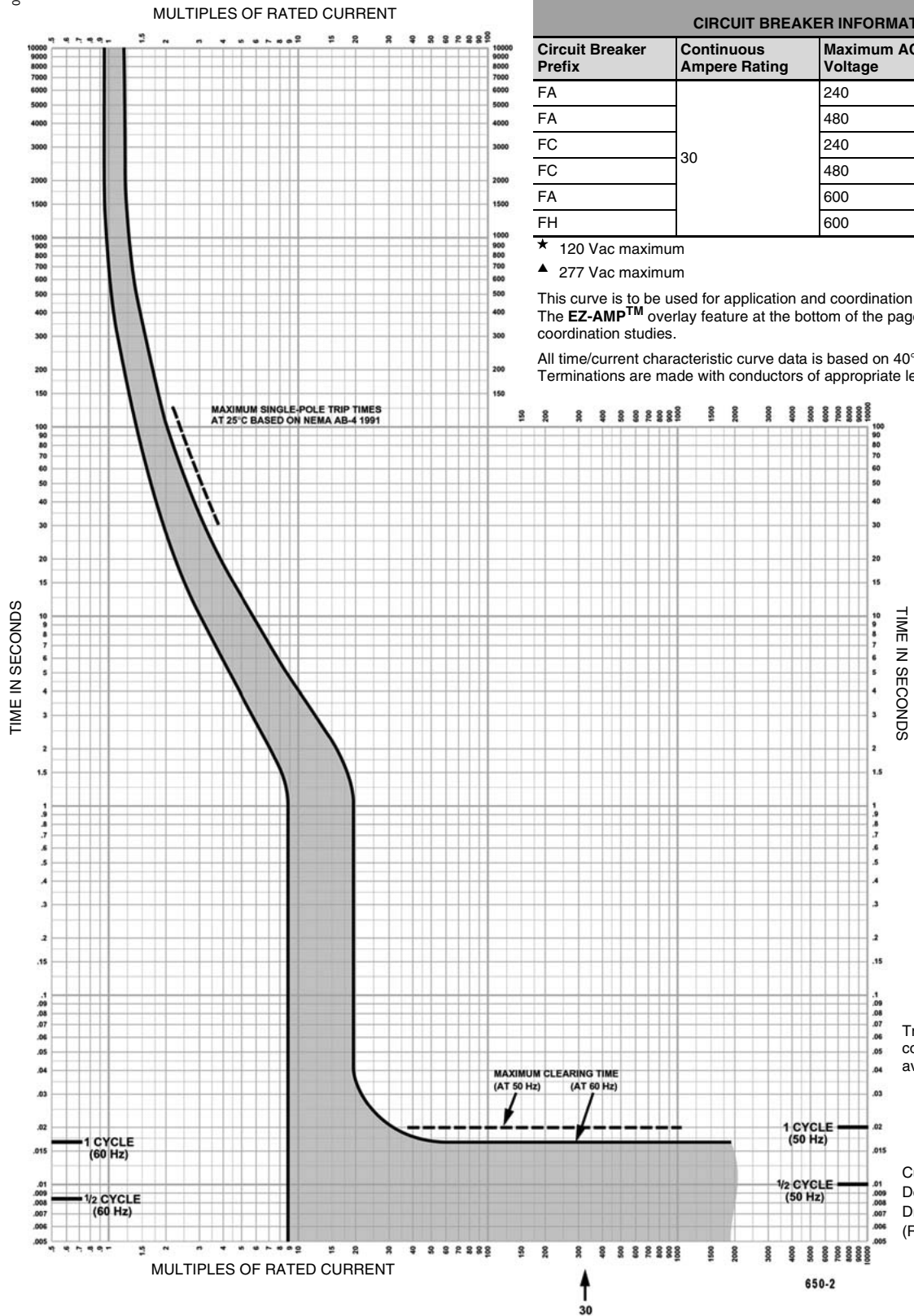

Tripping curves for coordination studies are available upon request.

Curve No. 0650TC0002  
December 2000  
Drawing No. B48095-650-02  
(Replaces 0650TC9002)

# Thermal-Magnetic / Magnetic Only Molded Case Circuit Breakers 100 Ampere Frame

06013039

## FA/FH/FC FAMILY MOLDED CASE CIRCUIT BREAKERS CHARACTERISTIC TRIP CURVE NO. 650-3

### CIRCUIT BREAKER INFORMATION

Circuit Breaker Prefix	Continuous Ampere Rating	Maximum AC Voltage	Number of Poles
FA	35-60	240	1★, 2, 3
FA		480	1▲, 2, 3
FC		240	2, 3
FC		480	2, 3
FA		600	2, 3
FH		600	1▲, 2, 3

★ 120 Vac maximum

▲ 277 Vac maximum

This curve is to be used for application and coordination purposes only. The **EZ-AMP™** overlay feature at the bottom of the page should be used during coordination studies.

All time/current characteristic curve data is based on 40°C ambient cold start. Terminations are made with conductors of appropriate length and ratings.

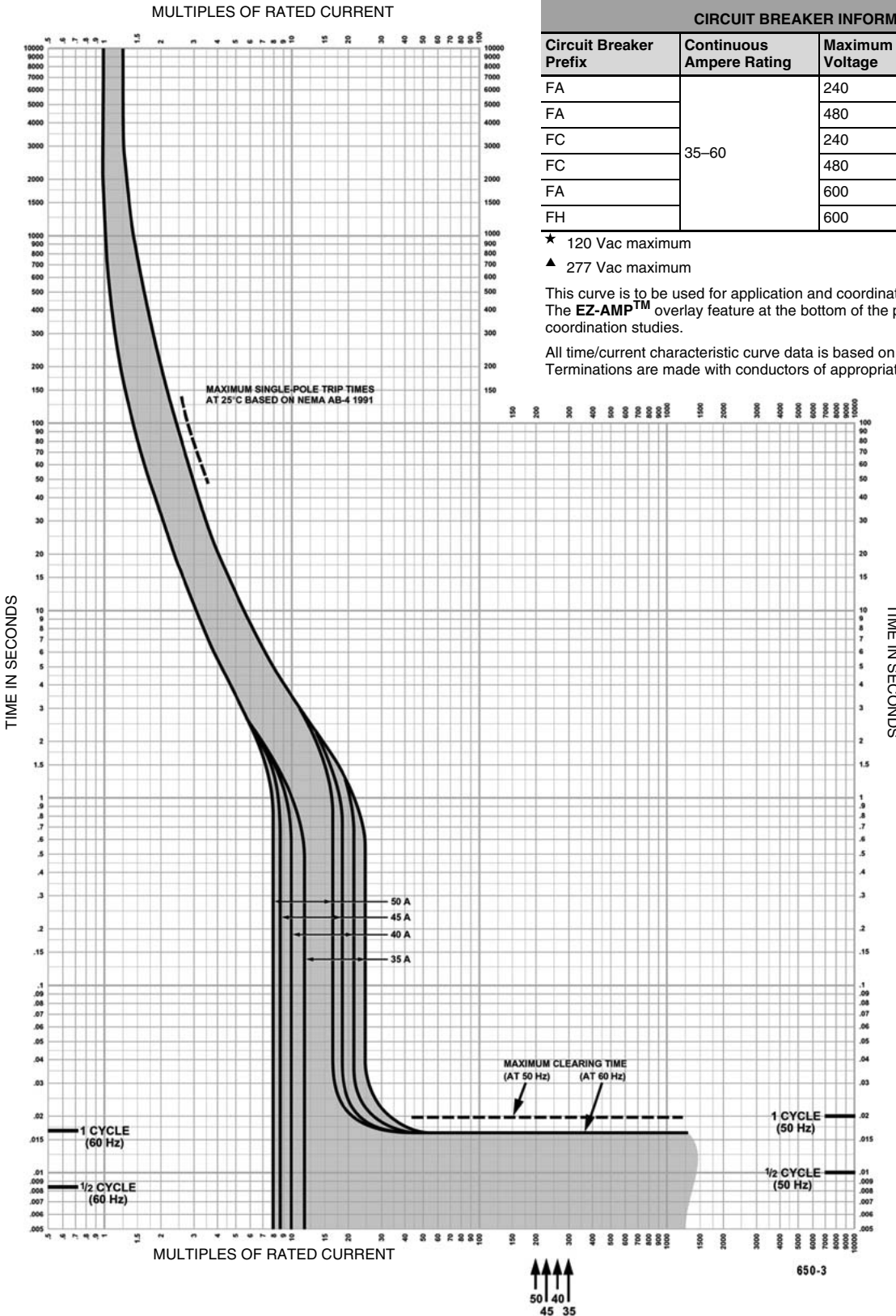

Tripping curves for coordination studies are available upon request.

Curve No. 0650TC0003  
December 2000  
Drawing No. B48095-650-03  
(Replaces 650-3, dated April, 1990)

# Thermal-Magnetic / Magnetic Only Molded Case Circuit Breakers 100 Ampere Frame

060130-00

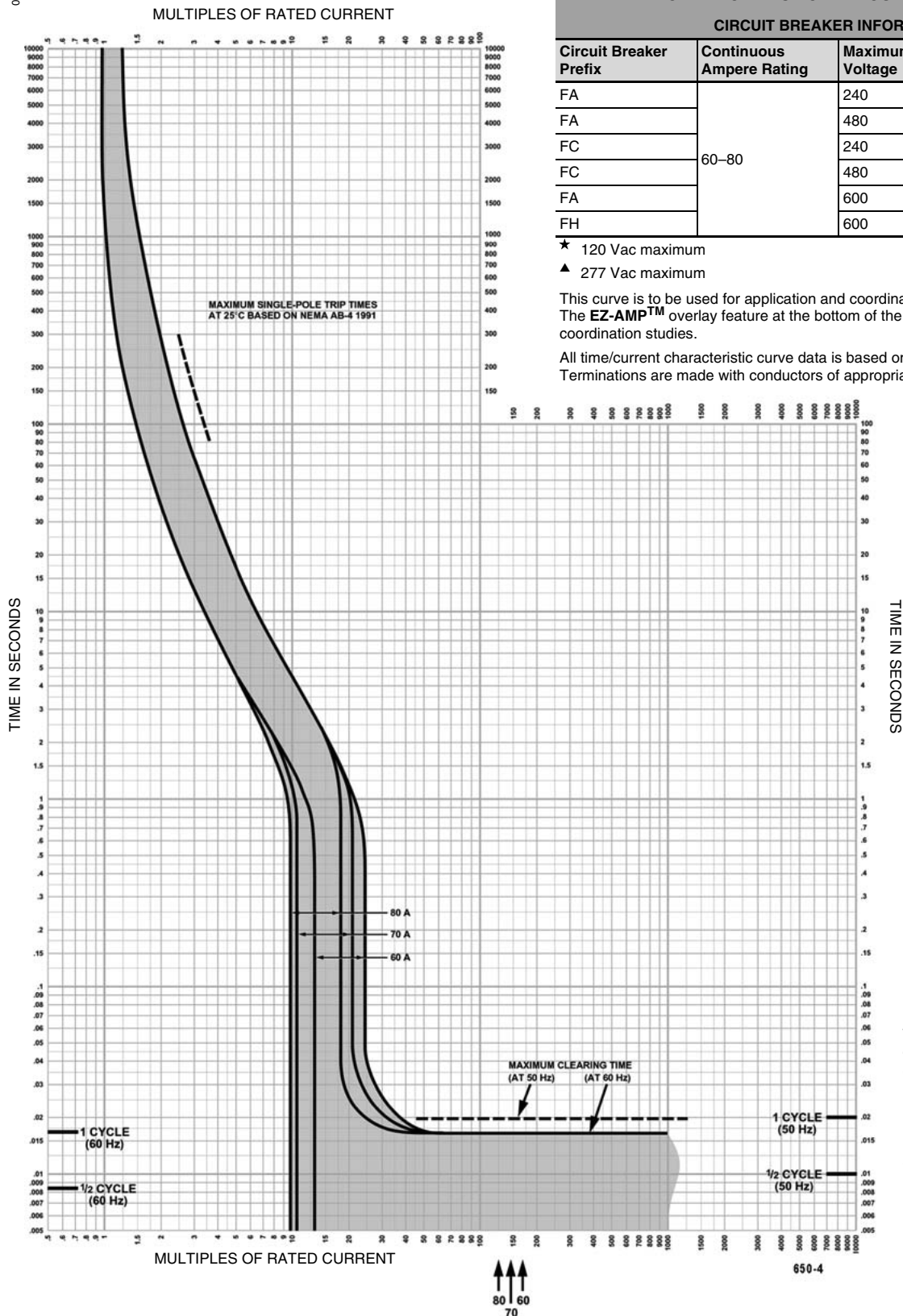

FA/FH/FC FAMILY MOLDED CASE CIRCUIT BREAKERS CHARACTERISTIC TRIP CURVE NO. 650-4			
CIRCUIT BREAKER INFORMATION			
Circuit Breaker Prefix	Continuous Ampere Rating	Maximum AC Voltage	Number of Pole
FA	60-80	240	1★, 2, 3
FA		480	1▲, 2, 3
FC		240	2, 3
FC		480	2, 3
FA		600	2, 3
FH		600	1▲, 2, 3

- ★ 120 Vac maximum
- ▲ 277 Vac maximum

This curve is to be used for application and coordination purposes only. The EZ-AMPT™ overlay feature at the bottom of the page should be used during coordination studies.

All time/current characteristic curve data is based on 40°C ambient cold start. Terminations are made with conductors of appropriate length and ratings.

Tripping curves for coordination studies are available upon request.

Curve No. 0650TC0004  
December 2000  
Drawing No. B48095-650-04  
(Replaces 0650TC9004)

# Thermal-Magnetic / Magnetic Only Molded Case Circuit Breakers 100 Ampere Frame

06013041

## FA/FH/FC FAMILY MOLDED CASE CIRCUIT BREAKERS CHARACTERISTIC TRIP CURVE NO. 650-5

### CIRCUIT BREAKER INFORMATION

Circuit Breaker Prefix	Continuous Ampere Rating	Maximum AC Voltage	Number of Poles
FA	90 & 100	240	1★, 2, 3
FA		480	1▲, 2, 3
FC		240	2, 3
FC		480	2, 3
FA		600	2, 3
FH		600	1▲, 2, 3

★ 120 Vac maximum

▲ 277 Vac maximum

This curve is to be used for application and coordination purposes only. The EZ-AMP™ overlay feature at the bottom of the page should be used during coordination studies.

All time/current characteristic curve data is based on 40°C ambient cold start. Terminations are made with conductors of appropriate length and ratings.

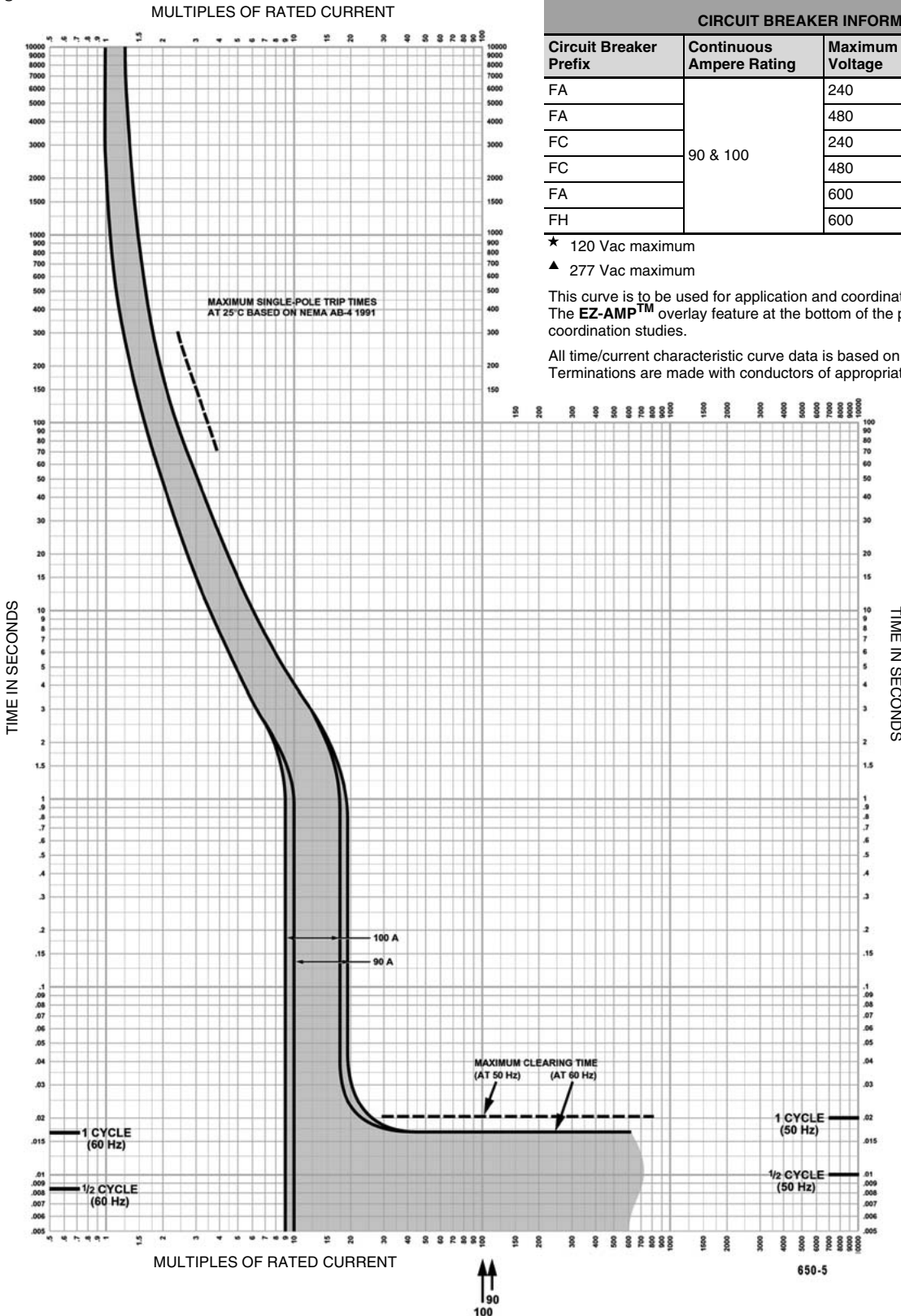

Tripping curves for coordination studies are available upon request.

Curve No. 0650TC0005  
December 2000  
Drawing No. B48095-650-05  
(Replaces 0650TC9005)

# Thermal-Magnetic / Magnetic Only Molded Case Circuit Breakers 100 Ampere Frame

## I-LIMITER® CURRENT LIMITING CIRCUIT BREAKERS CHARACTERISTIC TRIP CURVE NO. 820-5

CIRCUIT BREAKER INFORMATION			
Circuit Breaker Prefix	Continuous Ampere Rating	Maximum AC Voltage	Number of Poles
FI	20-30	600	2, 3

This curve is to be used for application and coordination purposes only. The EZ-AMP™ overlay feature at the bottom of the page should be used during coordination studies.

All time/current characteristic curve data is based on 40°C ambient cold start. Terminations are made with conductors of appropriate length and ratings.

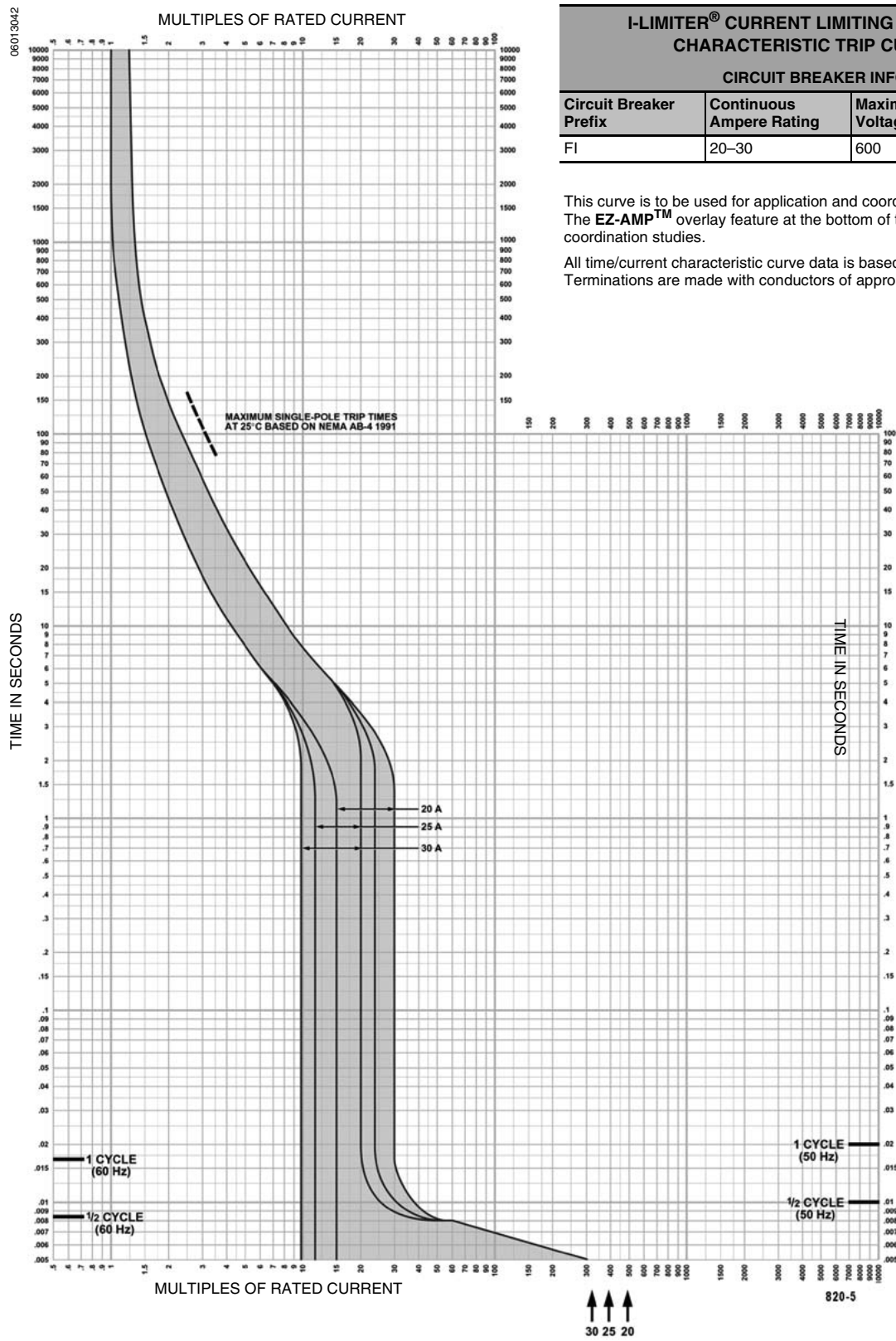

Tripping curves for coordination studies are available upon request.

Curve No. 0820TC0005  
December 2000  
Drawing No. B48095-820-05  
(Replaces 0820TC8505)

# Thermal-Magnetic / Magnetic Only Molded Case Circuit Breakers 100 Ampere Frame

06013043

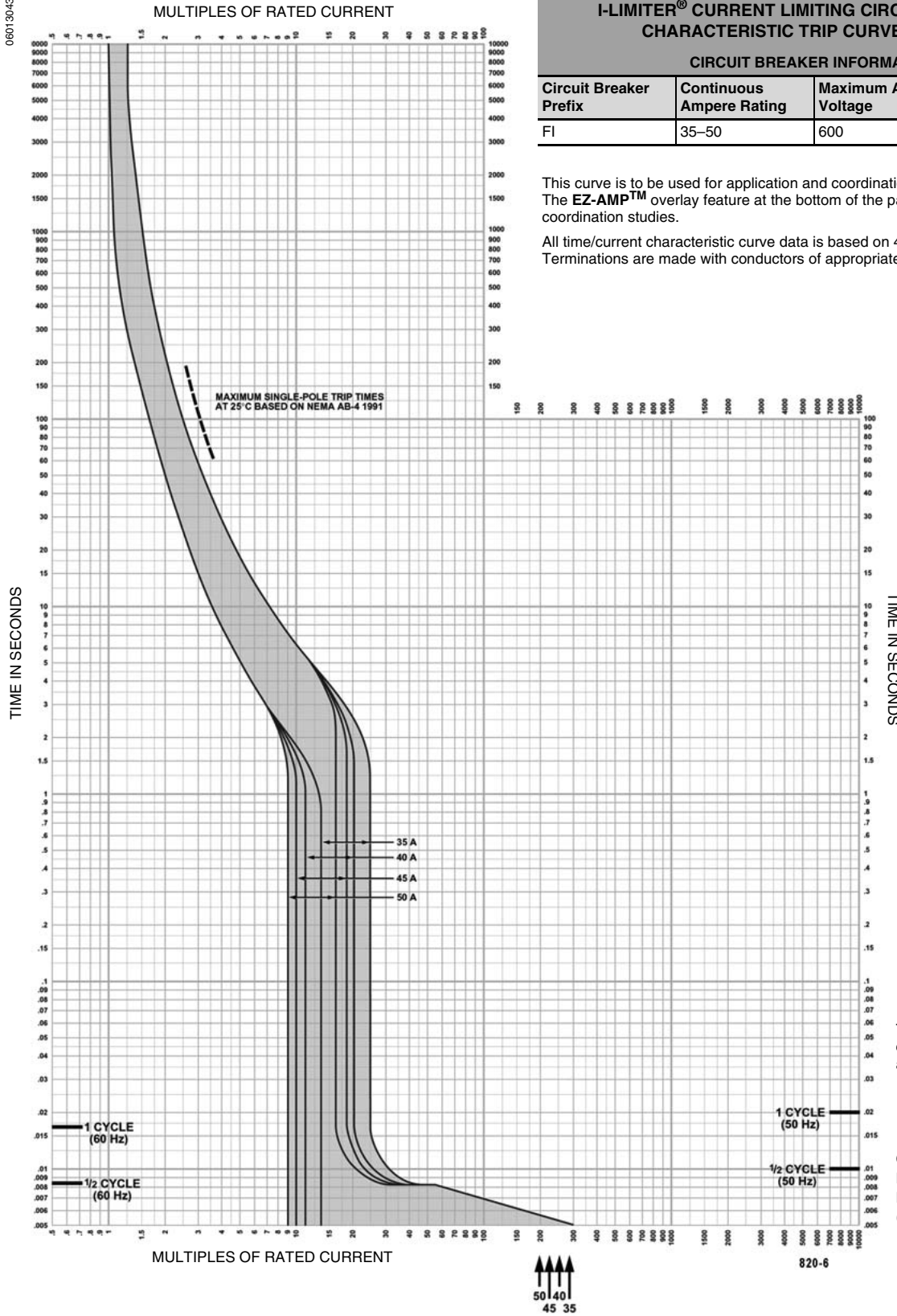

## I-LIMITER® CURRENT LIMITING CIRCUIT BREAKERS CHARACTERISTIC TRIP CURVE NO. 820-6

CIRCUIT BREAKER INFORMATION			
Circuit Breaker Prefix	Continuous Ampere Rating	Maximum AC Voltage	Number of Poles
FI	35-50	600	2, 3

This curve is to be used for application and coordination purposes only. The EZ-AMP™ overlay feature at the bottom of the page should be used during coordination studies.

All time/current characteristic curve data is based on 40°C ambient cold start. Terminations are made with conductors of appropriate length and ratings.

Tripping curves for coordination studies are available upon request.

Curve No. 0820TC0006  
December 2000  
Drawing No. B48095-820-06  
(Replaces 0820TC8506)

# Thermal-Magnetic / Magnetic Only Molded Case Circuit Breakers 100 Ampere Frame

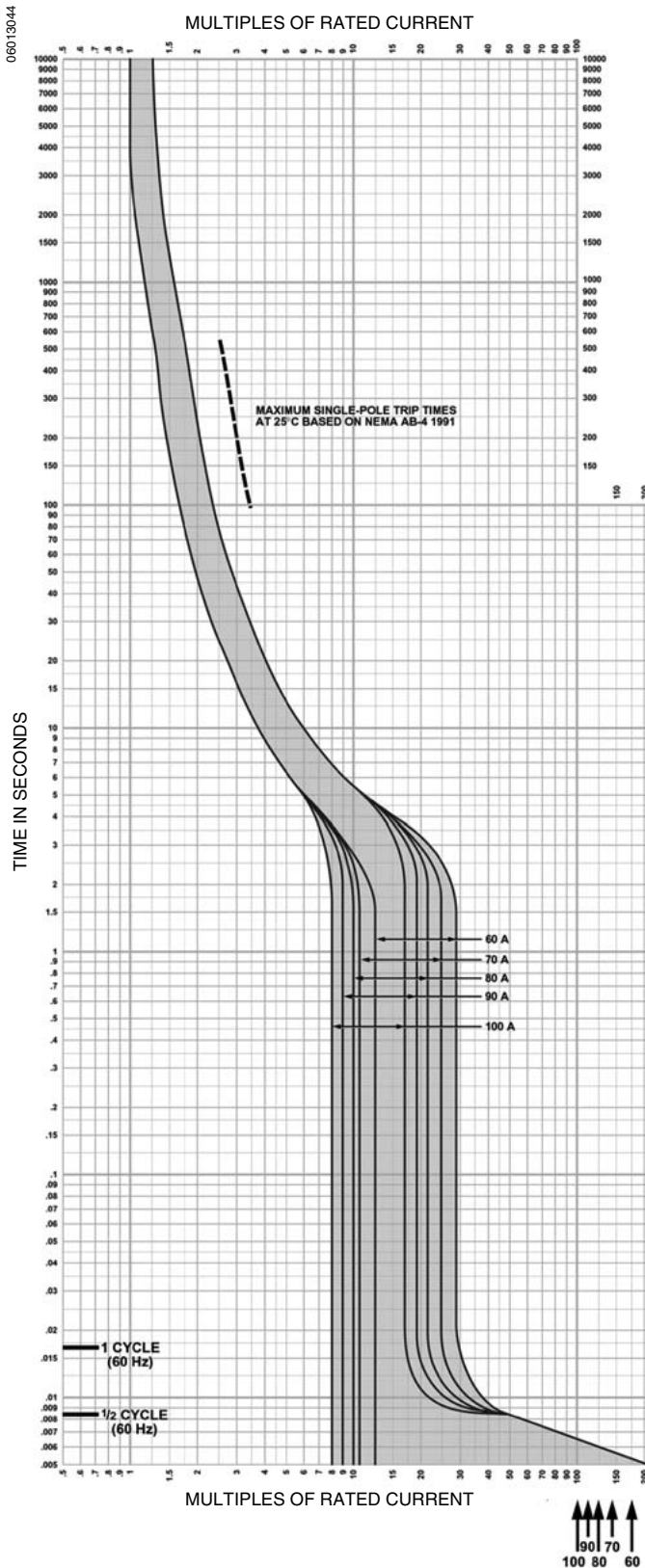

## I-LIMITER® CURRENT LIMITING CIRCUIT BREAKERS CHARACTERISTIC TRIP CURVE NO. 820-7

CIRCUIT BREAKER INFORMATION			
Circuit Breaker Prefix	Continuous Ampere Rating	Maximum AC Voltage	Number of Poles
F1	60-100	600	2, 3

This curve is to be used for application and coordination purposes only. The **EZ-AMPTM** overlay feature at the bottom of the page should be used during coordination studies.

All time/current characteristic curve data is based on 40°C ambient cold start. Terminations are made with conductors of appropriate length and ratings.

Tripping curves for coordination studies are available upon request.

Curve No. 0820TC0007  
December 2000  
Drawing No. B48095-820-07  
(Replaces 0820TC8507)

# Thermal-Magnetic / Magnetic Only Molded Case Circuit Breakers 100 Ampere Frame

060130-45

MULTIPLES OF RATED CURRENT

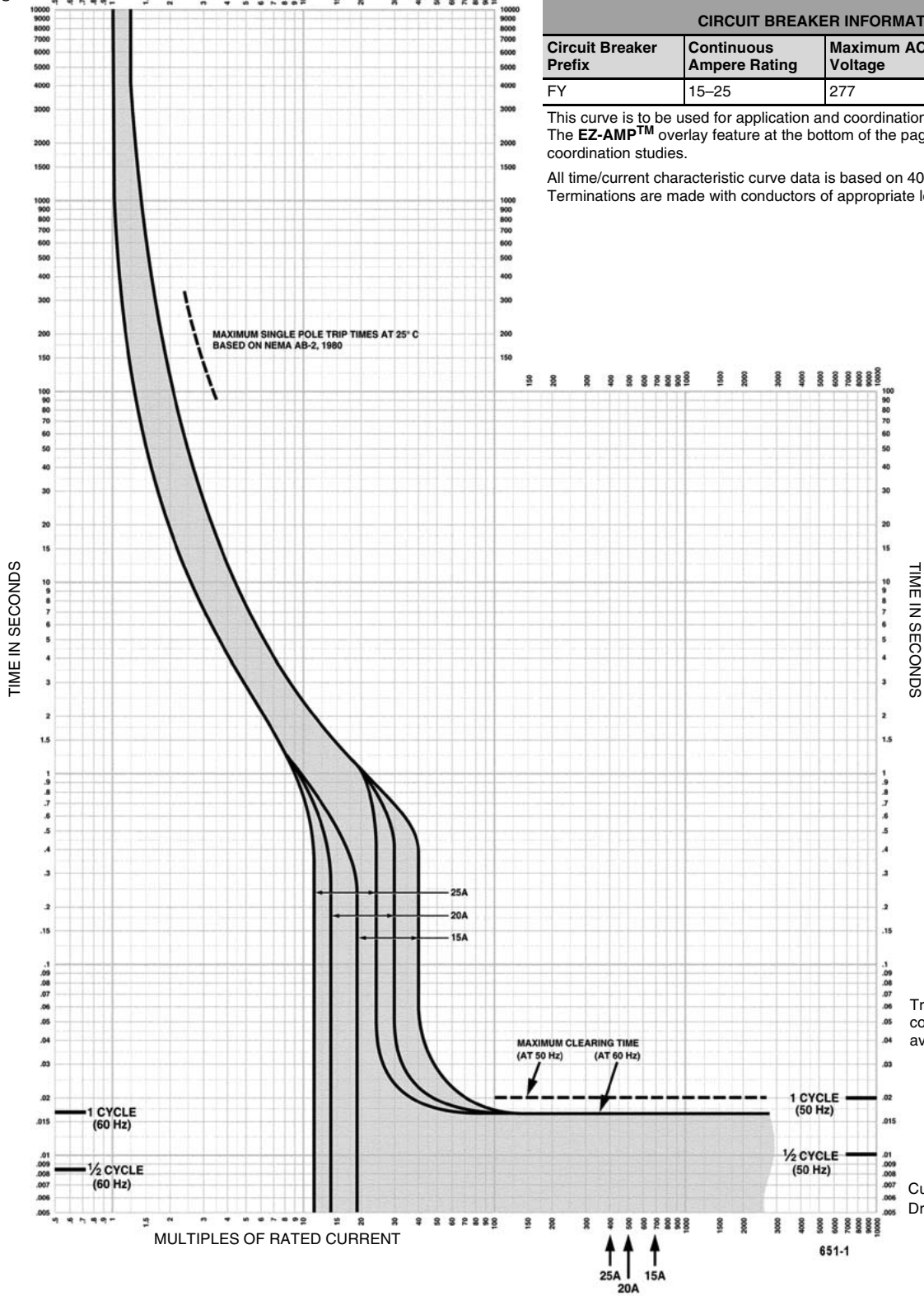

## FY THERMAL-MAGNETIC MOLDED CASE CIRCUIT BREAKERS CHARACTERISTIC TRIP CURVE NO. 651-1

CIRCUIT BREAKER INFORMATION			
Circuit Breaker Prefix	Continuous Ampere Rating	Maximum AC Voltage	Number of Poles
FY	15-25	277	1

This curve is to be used for application and coordination purposes only. The EZ-AMP™ overlay feature at the bottom of the page should be used during coordination studies.

All time/current characteristic curve data is based on 40°C ambient cold start. Terminations are made with conductors of appropriate length and ratings.

Tripping curves for coordination studies are available upon request.

Curve No. 0651TC9201  
Drawing No. B48095-651-01

# Thermal-Magnetic / Magnetic Only Molded Case Circuit Breakers 100 Ampere Frame

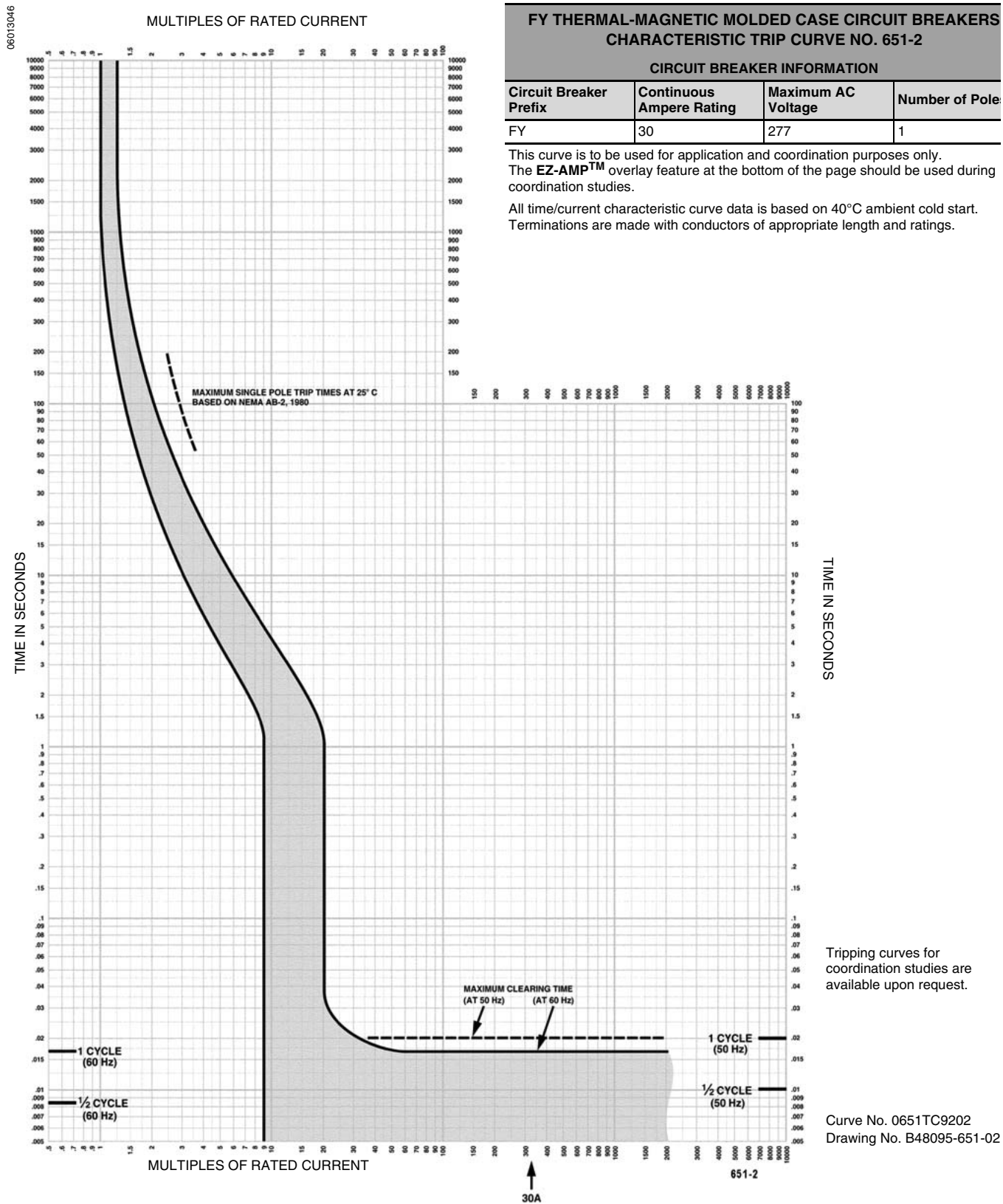

## FY THERMAL-MAGNETIC MOLDED CASE CIRCUIT BREAKERS CHARACTERISTIC TRIP CURVE NO. 651-2

CIRCUIT BREAKER INFORMATION			
Circuit Breaker Prefix	Continuous Ampere Rating	Maximum AC Voltage	Number of Pole
FY	30	277	1

This curve is to be used for application and coordination purposes only. The EZ-AMP™ overlay feature at the bottom of the page should be used during coordination studies.

All time/current characteristic curve data is based on 40°C ambient cold start. Terminations are made with conductors of appropriate length and ratings.

Tripping curves for coordination studies are available upon request.

Curve No. 0651TC9202  
Drawing No. B48095-651-02

# Thermal-Magnetic / Magnetic Only Molded Case Circuit Breakers 100 Ampere Frame

## Powerpack® Tripping Curves

06113478

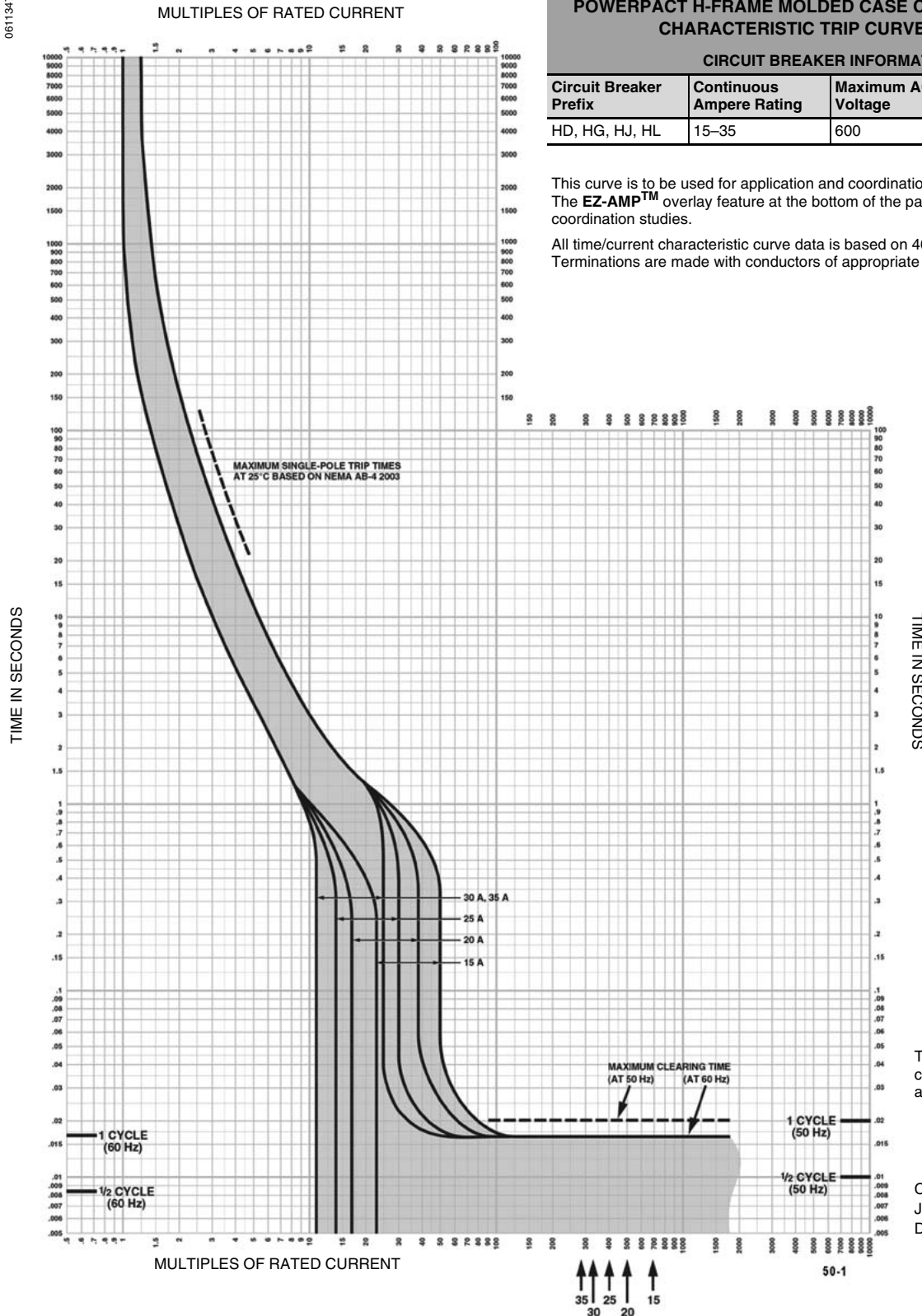

### POWERPACK H-FRAME MOLDED CASE CIRCUIT BREAKERS CHARACTERISTIC TRIP CURVE NO. 50-1

#### CIRCUIT BREAKER INFORMATION

Circuit Breaker Prefix	Continuous Ampere Rating	Maximum AC Voltage	Number of Poles
HD, HG, HJ, HL	15-35	600	2, 3

This curve is to be used for application and coordination purposes only. The **EZ-AMP™** overlay feature at the bottom of the page should be used during coordination studies.

All time/current characteristic curve data is based on 40°C ambient cold start. Terminations are made with conductors of appropriate length and ratings.

TIME IN SECONDS

Tripping curves for coordination studies are available upon request.

Curve No. 0050TC0401  
June 2004  
Drawing No. B48095-050-01

# Thermal-Magnetic / Magnetic Only Molded Case Circuit Breakers 100 Ampere Frame

06113479

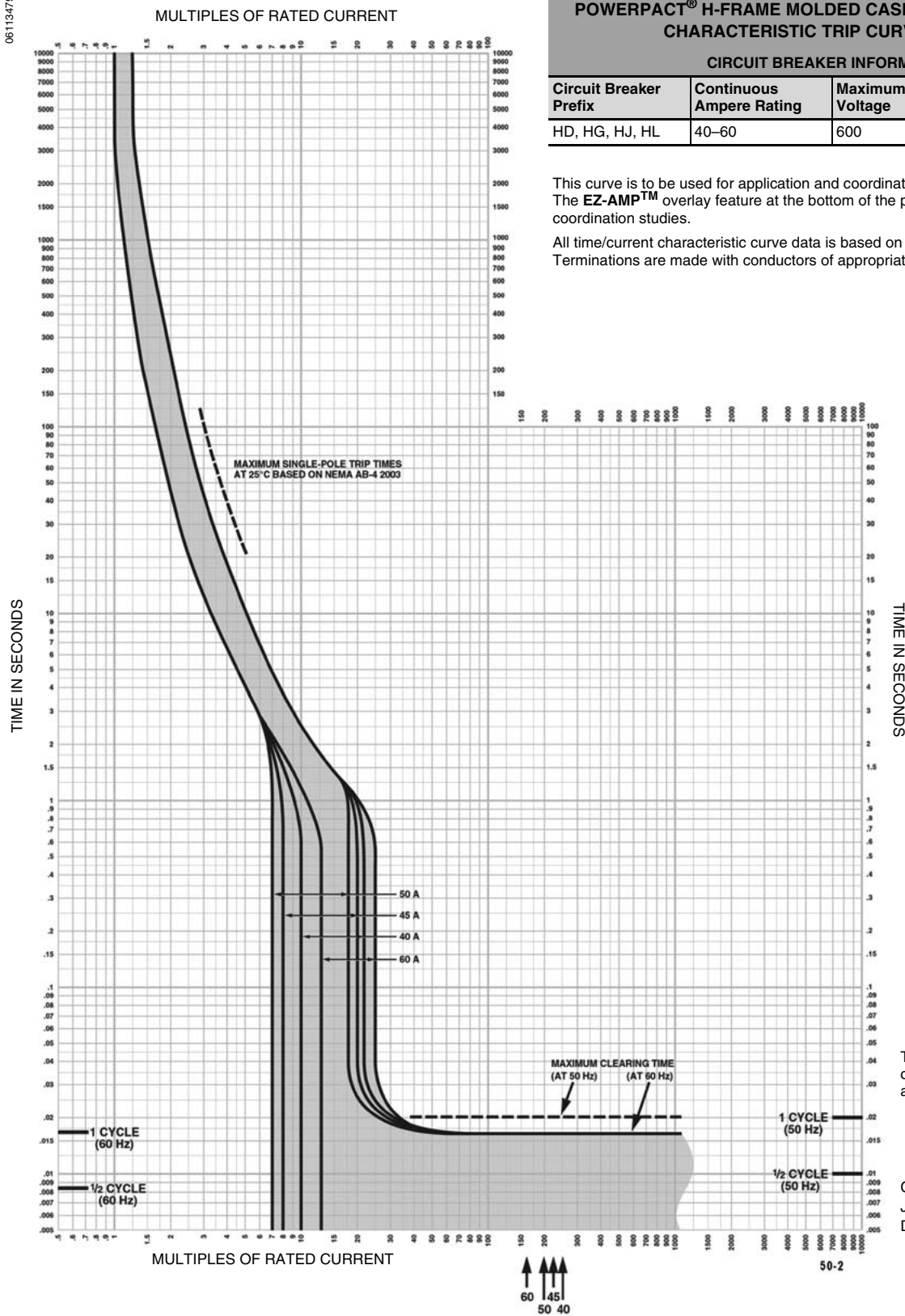

## POWERPACT® H-FRAME MOLDED CASE CIRCUIT BREAKERS CHARACTERISTIC TRIP CURVE NO. 50-2

### CIRCUIT BREAKER INFORMATION

Circuit Breaker Prefix	Continuous Ampere Rating	Maximum AC Voltage	Number of Poles
HD, HG, HJ, HL	40-60	600	2, 3

This curve is to be used for application and coordination purposes only. The **EZ-AMP™** overlay feature at the bottom of the page should be used during coordination studies.

All time/current characteristic curve data is based on 40°C ambient cold start. Terminations are made with conductors of appropriate length and ratings.

Tripping curves for coordination studies are available upon request.

Curve No. 0050TC0402  
June 2004  
Drawing No. B48095-050-02

# Thermal-Magnetic / Magnetic Only Molded Case Circuit Breakers 100 Ampere Frame

06113480

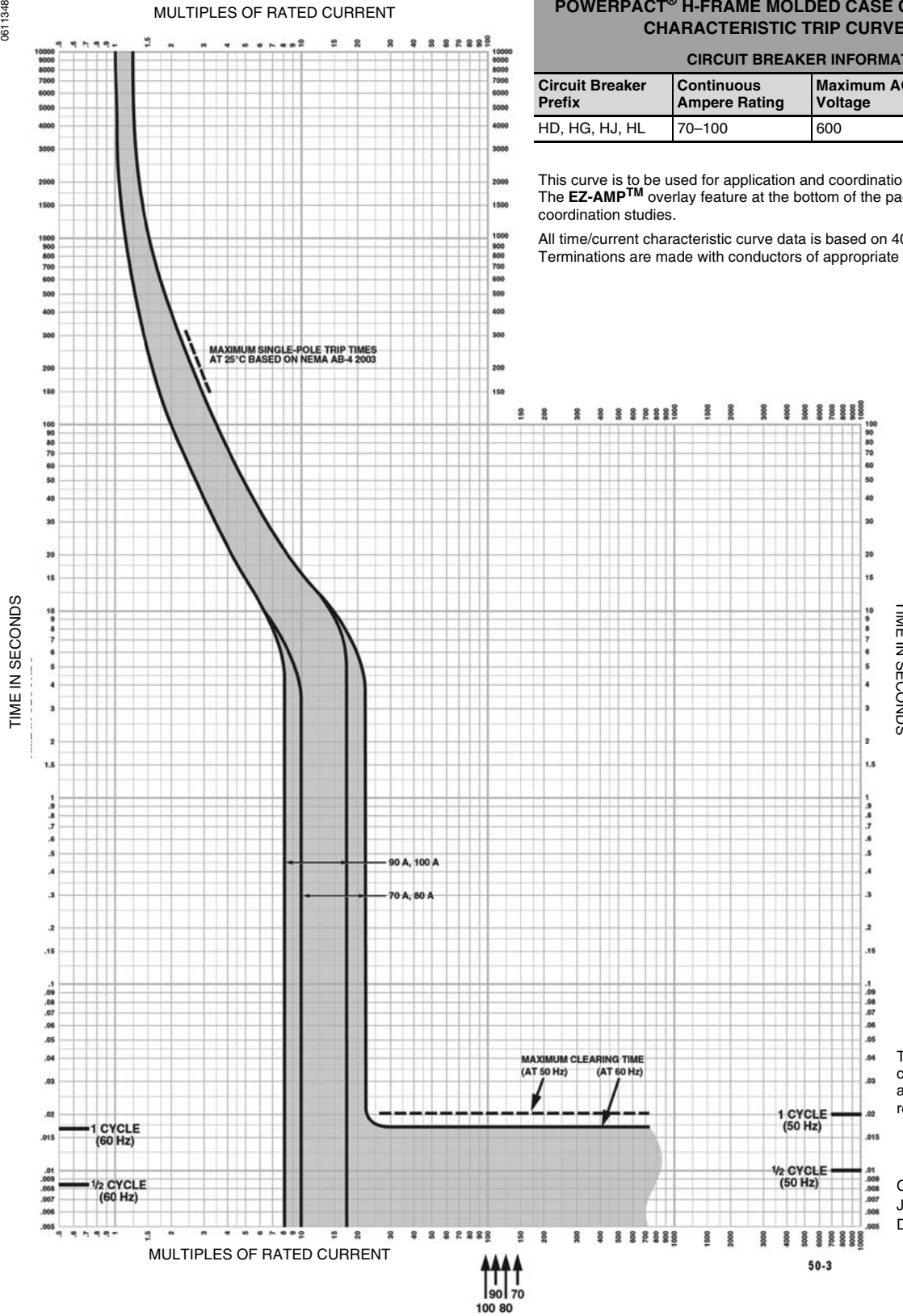

## POWERPACT® H-FRAME MOLDED CASE CIRCUIT BREAKERS CHARACTERISTIC TRIP CURVE NO. 50-3

CIRCUIT BREAKER INFORMATION			
Circuit Breaker Prefix	Continuous Ampere Rating	Maximum AC Voltage	Number of Poles
HD, HG, HJ, HL	70-100	600	2, 3

This curve is to be used for application and coordination purposes only. The EZ-AMP™ overlay feature at the bottom of the page should be used during coordination studies. All time/current characteristic curve data is based on 40°C ambient cold start. Terminations are made with conductors of appropriate length and ratings.

Tripping curves for coordination studies are available upon request.

Curve No. 0050TC0403  
June 2004  
Drawing No. B48095-050-03

# Thermal-Magnetic / Magnetic Only Molded Case Circuit Breakers 100 Ampere Frame

06113481

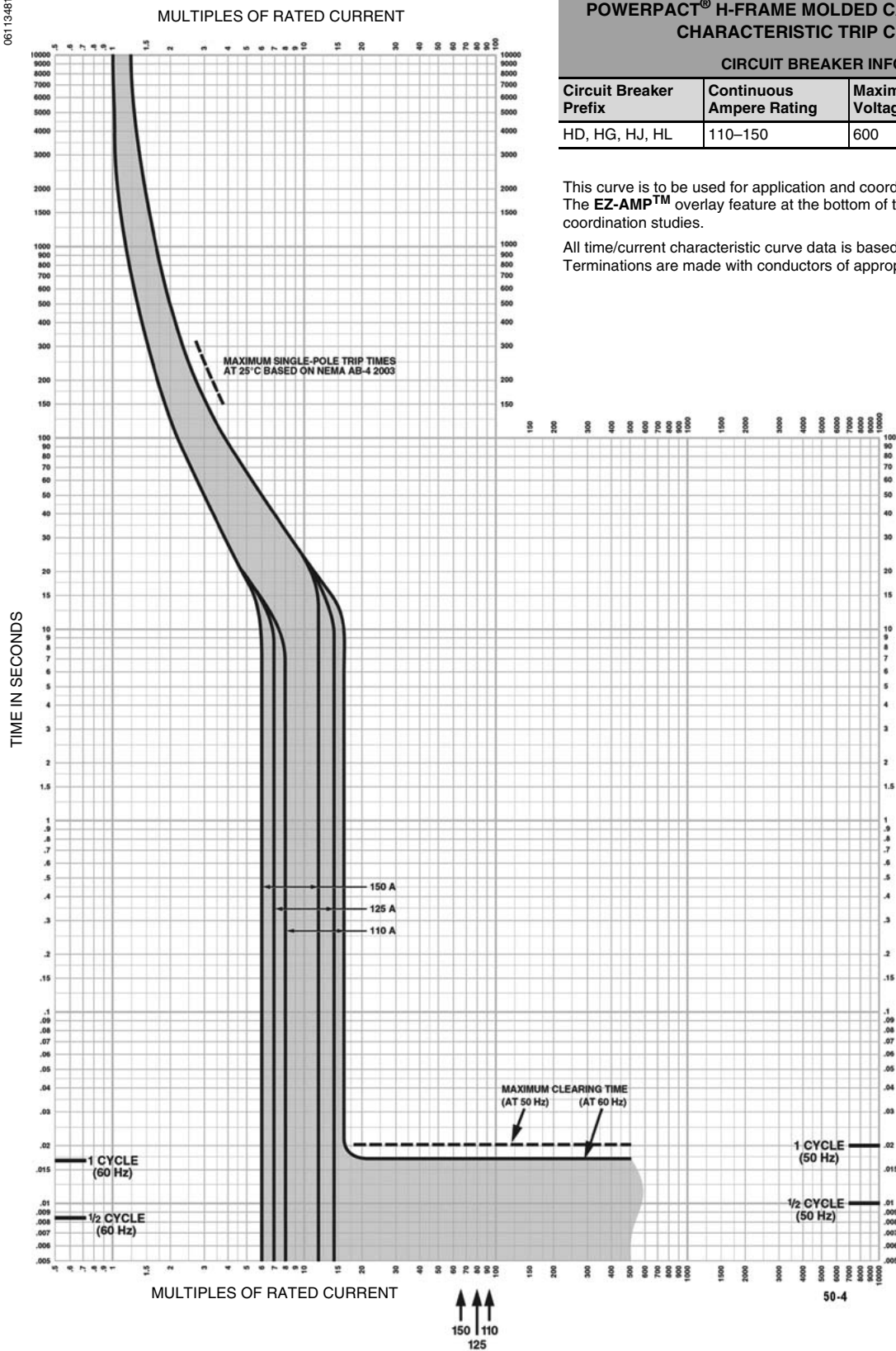

## POWERPACT® H-FRAME MOLDED CASE CIRCUIT BREAKERS CHARACTERISTIC TRIP CURVE NO. 50-4

### CIRCUIT BREAKER INFORMATION

Circuit Breaker Prefix	Continuous Ampere Rating	Maximum AC Voltage	Number of Poles
HD, HG, HJ, HL	110-150	600	2, 3

This curve is to be used for application and coordination purposes only. The **EZ-AMP™** overlay feature at the bottom of the page should be used during coordination studies.

All time/current characteristic curve data is based on 40°C ambient cold start. Terminations are made with conductors of appropriate length and ratings.

Tripping curves for coordination studies are available upon request.

Curve No. 0050TC0404  
June 2004  
Drawing No. B48095-050-04

# Thermal-Magnetic / Magnetic Only Molded Case Circuit Breakers 100 Ampere Frame

## Let-through Curves

**I-LIMITER® CURRENT LIMITING CIRCUIT BREAKERS**  
**FI 100 Ampere Frame at 240, 480 and 600 Vac, 3Ø**  
**20 Amperes**

Curve No. 820-1 Peak Let-Through Current  $I_p$   
 and 820-2 Let-Through  $I^2t$

06013047

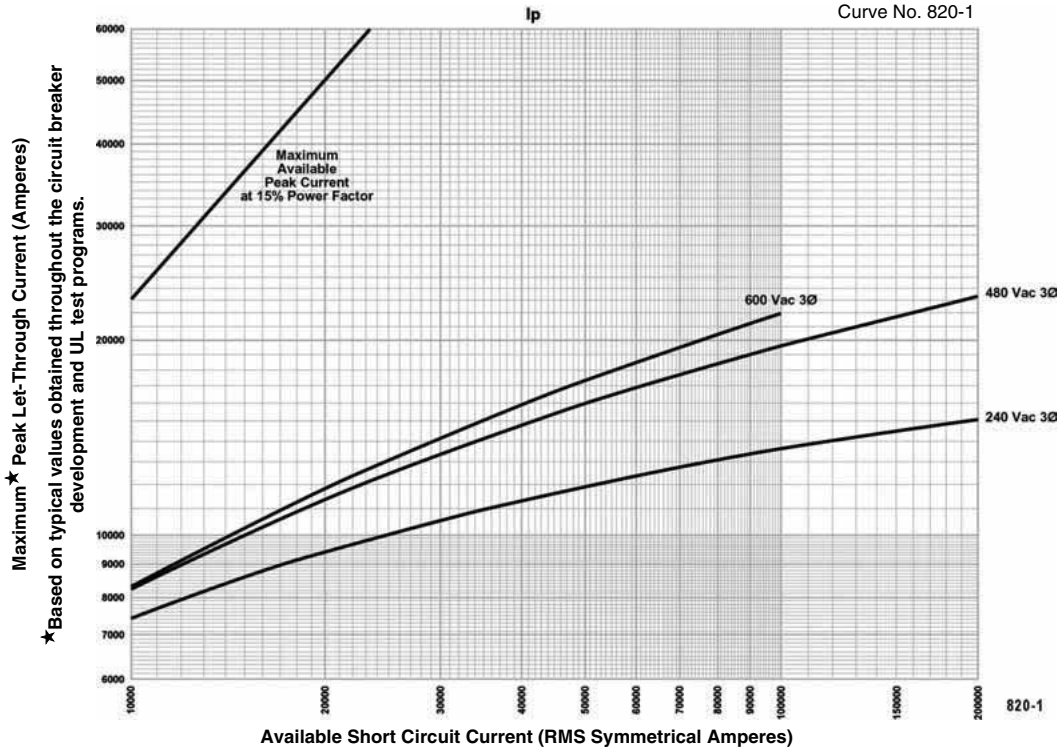

06013048

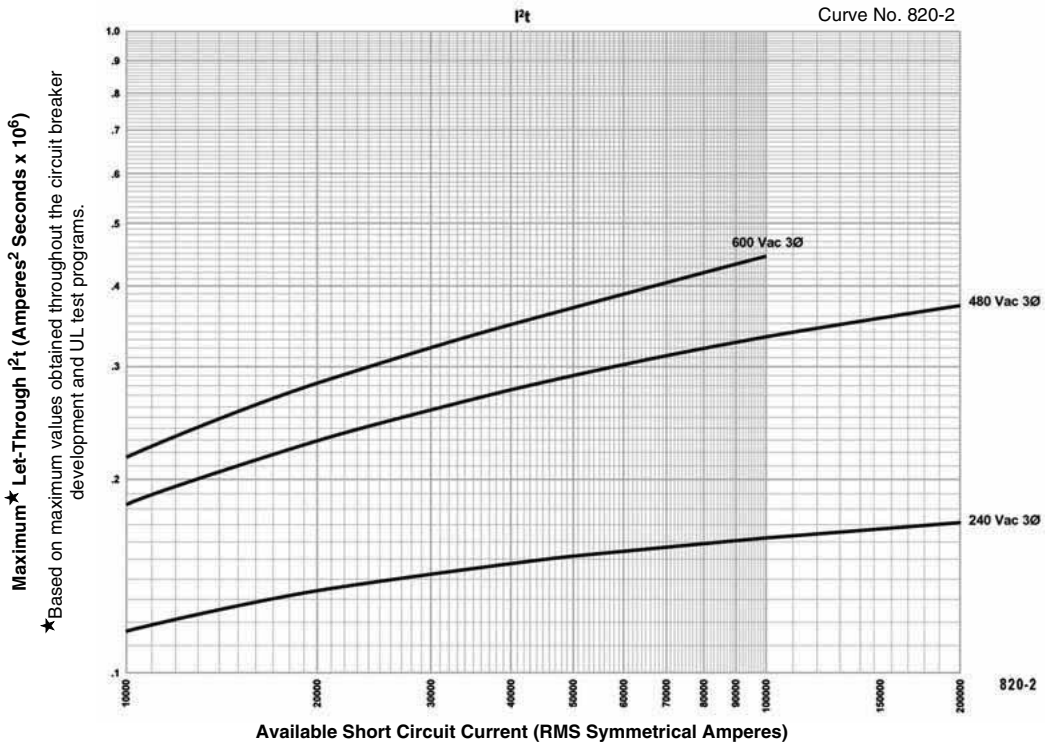

# Thermal-Magnetic / Magnetic Only Molded Case Circuit Breakers 100 Ampere Frame

## I-LIMITER® CURRENT LIMITING CIRCUIT BREAKERS FI 100 Ampere Frame at 240, 480 and 600 Vac, 3Ø 25–100 Amperes Curve No. 820-3 Peak Let-Through Current $I_p$ and 820-4 Let-Through $I^2t$

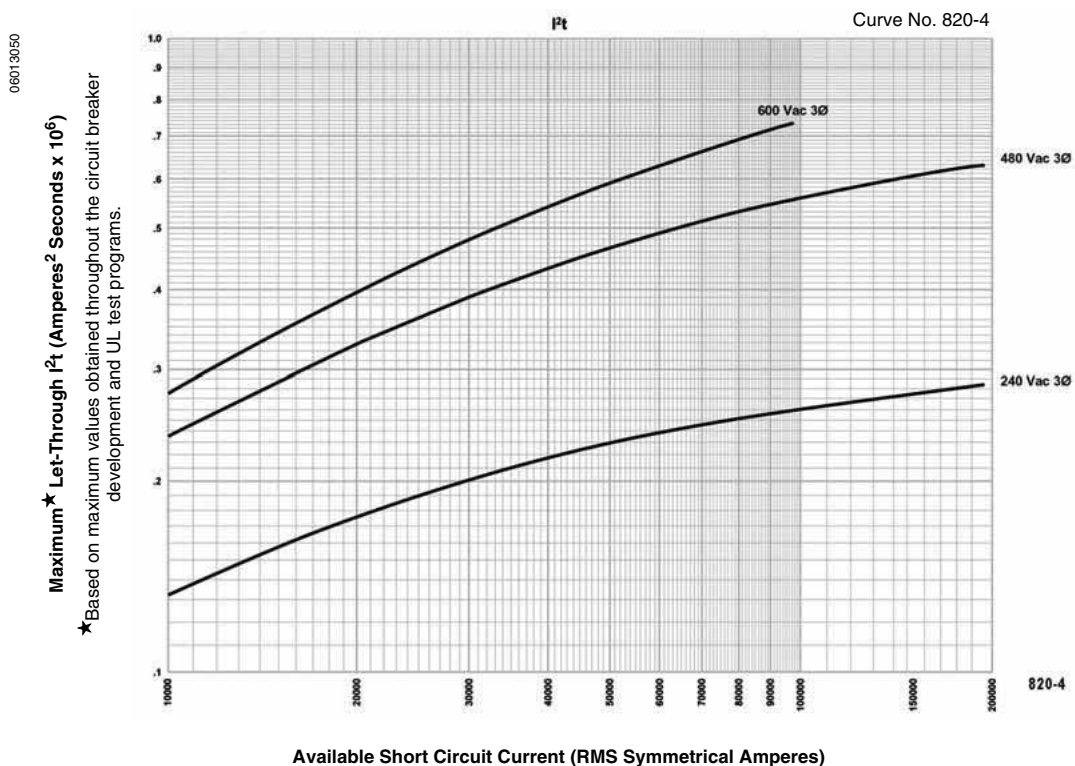
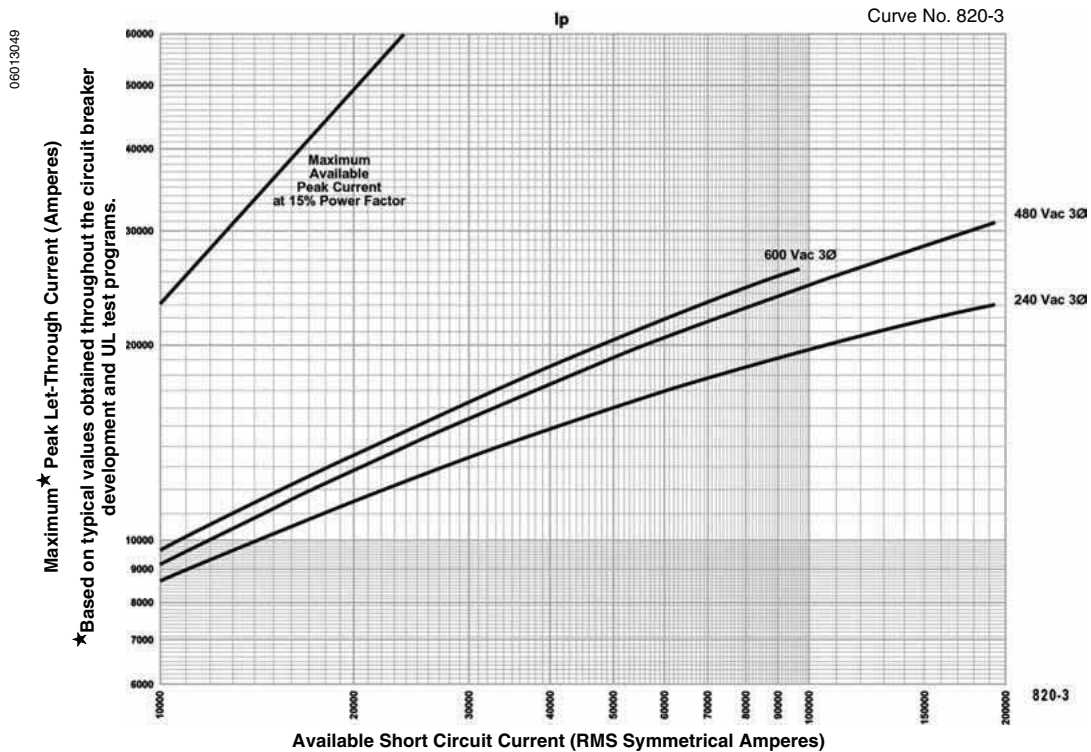

# Thermal-Magnetic / Magnetic Only Molded Case Circuit Breakers 100 Ampere Frame

## Powerpact® Let-through Curves

**POWERPACT H-FRAME CIRCUIT BREAKERS**  
**H-frame 150 Ampere (HD, HG, HJ, and HL)**  
**110–250 Amperes**  
**Curve No. 50-6 Let-Through  $I^2t$**   
**and 50-7 Peak Let-Through Current  $I_p$**

06113482

**Typical\* Let-Through  $I^2t$  (Amperes<sup>2</sup> Seconds x  $10^6$ )**

\*Based on typical values obtained throughout the circuit breaker development and UL test programs.

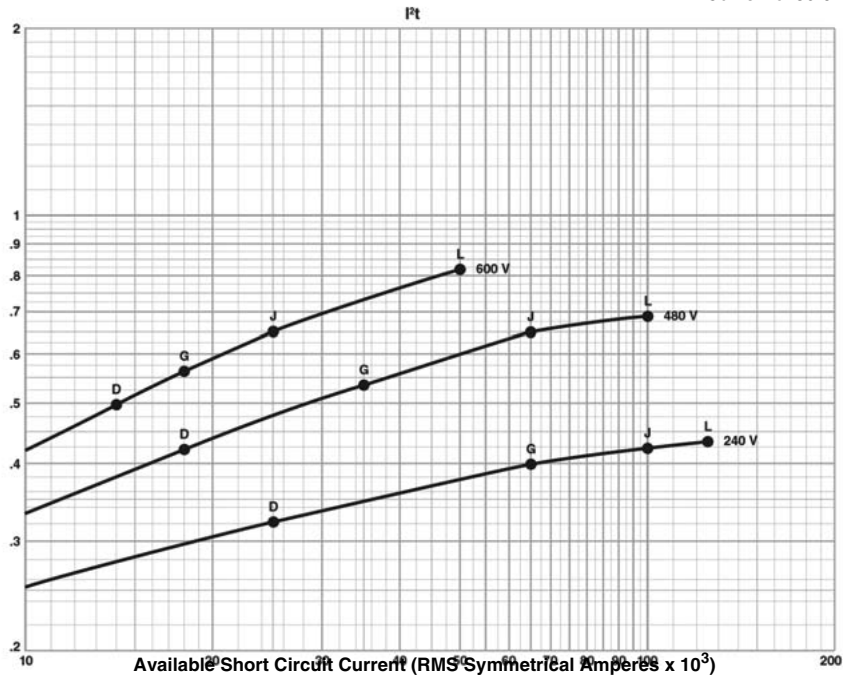

50-6

06113483

**Maximum\* Let-Through  $I^2t$  (Amperes<sup>2</sup> Seconds x  $10^3$ )**

\*Based on maximum values obtained throughout the circuit breaker development and UL test programs.

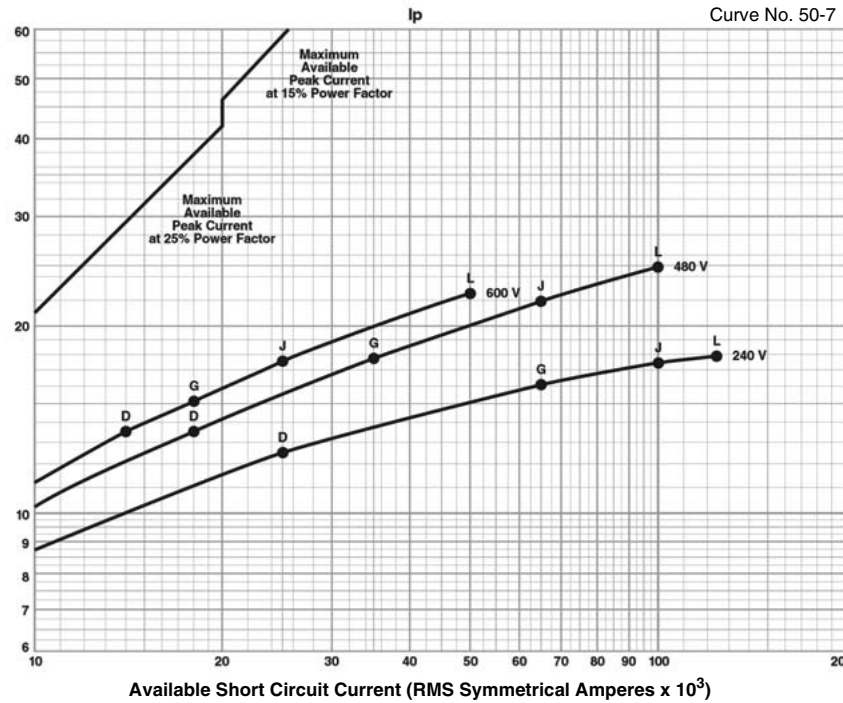

50-7

# Thermal-Magnetic / Magnetic Only Molded Case Circuit Breakers 225 / 250 Ampere Frame

## 225 / 250 AMPERE FRAME

This section provides specific information on Square D® 225 / 250 ampere frame thermal-magnetic molded case circuit breakers. For more information, see the Introduction in this catalog.

### Description

**Table 18: Description of 225 / 250 Ampere Frame Circuit Breakers**

Circuit Breaker	Description
QB, QD, QG, QJ	100–225 ampere, 240 Vac, 50/60 Hz, 2- and 3-pole.
JD, JG, JJ, JL	150–120 amperes, 600 Vac, 50/60 Hz, 3-pole
KA/KH	70–250 ampere, 600 Vac, 50/60 Hz 2- and 3-pole
KC	110–250 ampere, 480 Vac 50/60 Hz, 2- and 3-pole
KI	110–250 ampere, 600 Vac, 50/60 Hz, 2- and 3-pole current limiting

### Applications

- KI current limiting circuit breakers are used for electrical systems where high fault currents can occur.
- KA/KH, KC and KI circuit breakers are used in industrial enclosures, panelboards, switchboards, busway plug-in units, combination starters and motor control centers.
- QB, QD, QG, QJ (250 ampere Q-frame) circuit breakers are used in individual enclosures, metering devices, panelboards 225 ampere maximum I-Line®, and switchboards.

**Table 19: 250 Ampere Powerpack® Q-frame Interrupting Ratings (225 Ampere I-Line)★**

Catalog Number Prefix		No. of Poles	Cont. Ampere Rating	UL Listed Interrupting Rating (kA)									Federal Specs. W-C-375B/GEN	IEC 60947-2 Icu/Ics (kA) AC Voltage
Unit Mount	I-Line			AC Volts - RMS Symmetrical Amperes						DC Volts				
				120	120/240	240	480Y/277	480	600	125	250	500		415/240
QBL	QBA QBE	2	70–250▲	—	—	10	—	—	—	—	—	—	12b	10/5
QBM		3		—	—	10	—	—	—	—	—	—	12b	10/5
QMP QBF				—	—	10	—	—	—	—	—	—	12b	10/5
QDL	QDA QDE	2	70–250▲	—	—	25	—	—	—	—	—	—	14b	10/5
QDM		3		—	—	25	—	—	—	—	—	—	14b	10/5
QDP QDF				—	—	25	—	—	—	—	—	—	14b	10/5
QGL	QGA QGE	2	70–250▲	—	—	65	—	—	—	—	—	—	15b	10/5
QGM		3		—	—	65	—	—	—	—	—	—	15b	10/5
QGP QGF				—	—	65	—	—	—	—	—	—	15b	10/5
QJL	QJA QJE	2	70–250▲	—	—	100	—	—	—	—	—	—	15b	10/5
QJM		3		—	—	100	—	—	—	—	—	—	15b	10/5
QJP QJF				208Y/120 Vac: 100 kA	—	—	—	—	—	—	—	—	—	10/5

★ See Class 611, 612, 613, and 734 catalogs for other Powerpack and Masterpack® circuit breakers.

▲ 225 ampere I-Line.

# Thermal-Magnetic / Magnetic Only Molded Case Circuit Breakers 225 / 250 Ampere Frame

**Table 20: 250 Ampere Powerpack® J-frame Interrupting Ratings★**

Catalog Number Prefix		No. of Poles	Cont. Ampere Rating	UL Listed Interrupting Rating (kA)								Federal Specs. W-C-375B/GEN	IEC 60947-2 Icu/Ics (kA) AC Voltage	
Unit Mount	I-Line®			AC Volts - RMS Symmetrical Amperes					DC Volts				415	240
JD	JDA	2, 3	150-250	25	25	18	18	14	20	20	TBD	19a	18/4	25/6
JG	JGA			65	65	35	35	18	20	20	TBD	22a	35/8	65/16
JJ	JJA			100	100	65	65	25	20	20	TBD	23a	65/16	100/25
JL	JLA			125	125	100	100	50	20	20	TBD	25a	100/25	125/31

★ See Powerpack H- and J-frame catalog, Class 611, for more information. Also, see Class 612, 613, and 734 catalogs for other Powerpack and Masterpack® circuit breakers.

**Table 21: 250 Ampere Frame Interrupting Ratings**

Catalog Number Prefix		No. of Poles	Cont. Ampere Rating	UL Listed Interrupting Rating (kA)									Federal Specs. W-C-375B/GEN	IEC 60947-2 Icu/Ics (kA) AC Voltage
Unit Mount	I-Line			AC Volts - RMS Symmetrical Amperes					DC Volts					415/240
KAL	KA	2, 3	70-250	42	42	42	25	25	22	10	10	—	19a, 20a	10/2.5
KHL★	KH★	2, 3	70-250	65	65	65	35	35	25	10	10	—	23a	10/2.5
KHL-DC▲	—	3	—	—	—	—	—	—	—	—	—	20	—	—
KCL	KC	2, 3	110-250	100	100	100	65	65	—	—	—	—	23a	65/65
KIL	KI	2, 3	110-250	200	200	200	200	200	100	—	—	—	16a	130/65

★ Separate UL rating available for 240 Vac and 480 Vac grounded B single phase systems. Breakers must be ordered with 5861 suffix.

▲ UL Listed 500 Vdc rating for use on ungrounded systems. Must be connected 3 poles in series. Consult your local Square D® sales office for additional information 1-888-Square D.

## Selection Data

**Table 22: 250 Ampere Frame Unit Mount Circuit Breakers**

Ampere Rating	AC Magnetic Trip Settings Amperes★		Two Pole Catalog No.	Three Pole Catalog No.	Standard Lug Kit Wire Range
<b>KAL Standard Interrupting</b>					
	Low	High	600 Vac/250 Vdc	600 Vac/250 Vdc	
70	350	700	KAL26070	KAL36070	AL250KA 1-#6-350 kcmil
80	400	800	KAL26080	KAL36080	
90	450	900	KAL26090	KAL36090	
100	500	1000	KAL26100	KAL36100	
110	550	1100	KAL26110	KAL36110	
125	625	1250	KAL26125	KAL36125	
150	750	1500	KAL26150	KAL36150	
175	875	1750	KAL26175	KAL36175	
200	1000	2000	KAL26200	KAL36200	
225	1125	2250	KAL26225	KAL36225	
250	1250	2500	KAL26250	KAL36250	



**KAL/KHL Two- and Three-pole 70-250 Ampere**

*Continued on next page*

# Thermal-Magnetic / Magnetic Only Molded Case Circuit Breakers 225 / 250 Ampere Frame

**Table 22: 250 Ampere Frame Unit Mount Circuit Breakers (continued)**

Ampere Rating	AC Magnetic Trip Settings Amperes★		Two Pole Catalog No.	Three Pole Catalog No.	Standard Lug Kit Wire Range
<b>KHL High Interrupting</b>					
	Low	High	600 Vac/250 Vdc	600 Vac/250 Vdc	
70	350	700	KHL26070	KHL36070	AL250KA 1-#6-350 kcmil
80	400	800	KHL26080	KHL36080	
90	450	900	KHL26090	KHL36090	
100	500	1000	KHL26100	KHL36100	
110	550	1100	KHL26110	KHL36110	
125	625	1250	KHL26125	KHL36125	
150	750	1500	KHL26150	KHL36150	
175	875	1750	KHL26175	KHL36175	
200	1000	2000	KHL26200	KHL36200	
225	1125	2250	KHL26225	KHL36225	
250	1250	2500	KHL26250	KHL36250	
<b>KCL Extra High Interrupting</b>					
	Low	High	480 Vac	480 Vac	
110	550	1100	KCL24110	KCL34110	AL250KA 1-#6-350 kcmil
125	625	1250	KCL24125	KCL24125	
150	750	1500	KCL24150	KCL34150	
175	875	1750	KCL24175	KCL34175	
200	1000	2000	KCL24200	KCL34200	AL250KI 1-1/0-350 kcmil
225	1125	2250	KCL24225	KCL34225	
250	1250	2500	KCL24250	KCL34250	
<b>KIL I-Limiter® Current Limiting</b>					
	Low	High	600 Vac	600 Vac	
110	550	1100	KIL26110	KIL36110	AL250KA 1-#6-350 kcmil
125	625	1250	KIL26125	KIL36125	
150	750	1500	KIL26150	KIL36150	
175	875	1750	KIL26175	KIL36175	
200	1000	2000	KIL26200	KIL36200	AL250KI 1-1/0-350 kcmil
225	1125	2250	KIL26225	KIL36225	
250	1250	2500	KIL26250	KIL36250	



**KIL Two- and Three-pole  
110-250 Ampere**

★ UL magnetic trip setting tolerances are -20% /+30% (Low) and -20% /+30% (High) from the nominal values shown.

**Table 23: 250 Ampere Frame I-Line® Circuit Breakers**

Ampere Rating	AC Magnetic Trip Settings Amperes▲		Two Pole★ Catalog No.	Three Pole Catalog No.	Standard Lug Kit Wire Range
<b>KA Standard Interrupting</b>					
	Low	High	600 Vac/250 Vdc	600 Vac/250 Vdc	
70	350	700	KA26070( )	KA36070	AL250KA 1-#6-350 kcmil
80	400	800	KA26080( )	KA36080	
90	450	900	KA26090( )	KA36090	
100	500	1000	KA26100( )	KA36100	
110	550	1100	KA26110( )	KA36110	
125	625	1250	KA26125( )	KA36125	
150	750	1500	KA26150( )	KA36150	
175	875	1750	KA26175( )	KA36175	
200	1000	2000	KA26200( )	KA36200	
225	1125	2250	KA26225( )	KA36225	
250	1250	2500	KA26250( )	KA36250	



**KA Two- and Three-pole  
70-250 Ampere  
4-1/2" Mounting Height**

Continued on next page

## Thermal-Magnetic / Magnetic Only Molded Case Circuit Breakers 225 / 250 Ampere Frame

**Table 23: 250 Ampere Frame I-Line® Circuit Breakers (continued)**

Ampere Rating	AC Magnetic Trip Settings Amperes <sup>▲</sup>		Two Pole★ Catalog No.	Three Pole Catalog No.	Standard Lug Kit Wire Range
<b>KH High Interrupting</b>					
	Low	High	600 Vac/250 Vdc	600Vac/250Vdc	
70	350	700	KH26070( )	KH36070	AL250KA 1-#6-350 kcmil
80	400	800	KH26080( )	KH36080	
90	450	900	KH26090( )	KH36090	
100	500	1000	KH26100( )	KH36100	
110	550	1100	KH26110( )	KH36110	
125	625	1250	KH26125( )	KH36125	
150	750	1500	KH26150( )	KH36150	
175	875	1750	KH26175( )	KH36175	
200	1000	2000	KH26200( )	KH36200	
225	1125	2250	KH26225( )	KH36225	
250	1250	2500	KH26250( )	KH36250	
<b>KC Extra High Interrupting</b>					
	Low	High	480 Vac	480 Vac	
110	550	1100	KC24110( )	KC34110	AL250KA 1-#6-350 kcmil
125	625	1250	KC24125( )	KC34125	
150	750	1500	KC24150( )	KC34150	
175	875	1750	KC24175( )	KC34175	
200	1000	2000	KC24200( )	KC34200	AL250KI 1-1/0-350 kcmil
225	1125	2250	KC24225( )	KC34225	
250	1250	2500	KC24250( )	KC34250	
<b>KI I-Limiter® Current Limiting</b>					
	Low	High	600 Vac	600 Vac	
110	550	1100	KI26110( )	KI36110	AL250KA 1-#6-350 kcmil
125	625	1250	KI26125( )	KI36125	
150	750	1500	KI26150( )	KI36150	
175	875	1750	KI26175( )	KI36175	
200	1000	2000	KI26200( )	KI36200	AL250KI 1-1/0-350 kcmil
225	1125	2250	KI26225( )	KI36225	
250	1250	2500	KI26250( )	KI36250	



**KI Two- and Three-pole  
110–250 Ampere  
4-1/2" Mounting Height**

★ Two pole circuit breaker catalog numbers are completed by adding required phase connection letters as a suffix to the catalog number.

▲ UL magnetic trip setting tolerances are -20% /+30% (Low) and -20% /+30% (High) from the nominal values shown.

### Powerpact® Selection Data

For Powerpact selection information see Class 611, 612, 613, and 734 catalogs.



**Q-frame: Class 734**



**J-frame: Class 611**

# Thermal-Magnetic / Magnetic Only Molded Case Circuit Breakers 225 / 250 Ampere Frame

## Dimensions

Figure 13: KAL, KHL, KCL, KIL 250 Ampere Frame

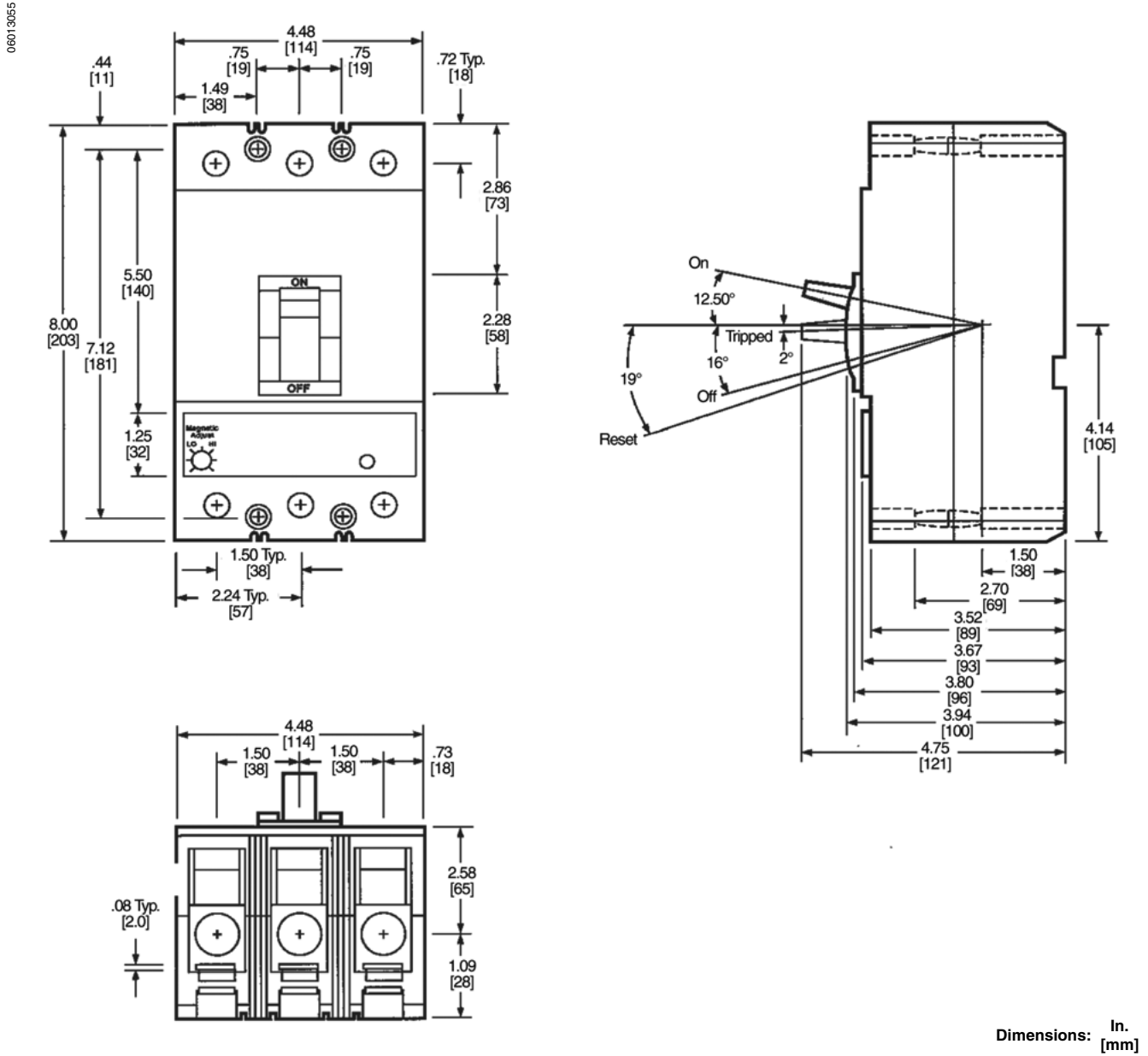

# Thermal-Magnetic / Magnetic Only Molded Case Circuit Breakers 225 / 250 Ampere Frame

## Tripping Curves

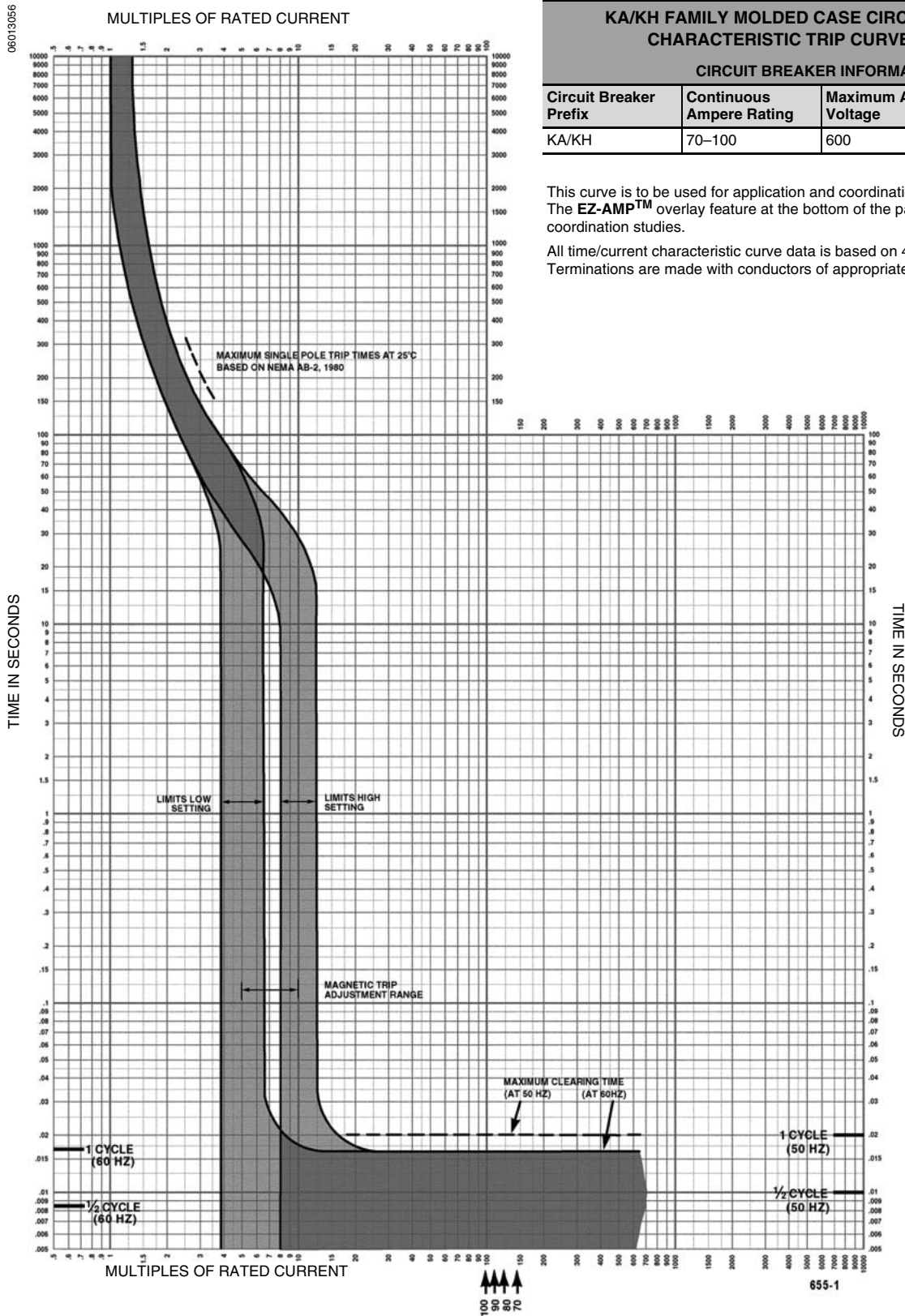

KA/KH FAMILY MOLDED CASE CIRCUIT BREAKERS CHARACTERISTIC TRIP CURVE NO. 655-1			
CIRCUIT BREAKER INFORMATION			
Circuit Breaker Prefix	Continuous Ampere Rating	Maximum AC Voltage	Number of Poles
KA/KH	70-100	600	2, 3

This curve is to be used for application and coordination purposes only. The **EZ-AMP™** overlay feature at the bottom of the page should be used during coordination studies.

All time/current characteristic curve data is based on 40°C ambient cold start. Terminations are made with conductors of appropriate length and ratings.

Tripping curves for coordination studies are available upon request.

Curve No. 655-1  
May 1985

# Thermal-Magnetic / Magnetic Only Molded Case Circuit Breakers 225 / 250 Ampere Frame

06013057

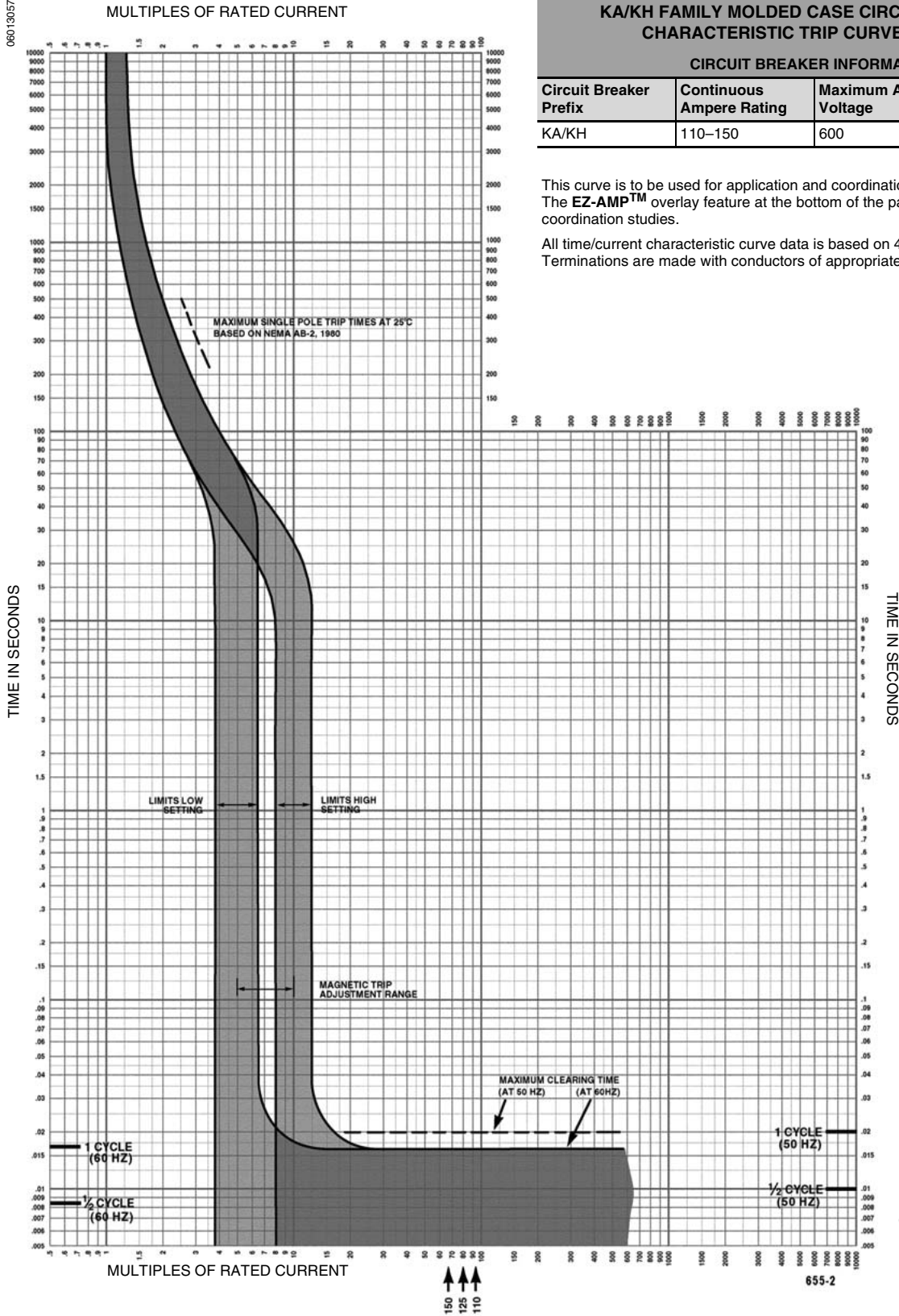

## KA/KH FAMILY MOLDED CASE CIRCUIT BREAKERS CHARACTERISTIC TRIP CURVE NO. 655-2

### CIRCUIT BREAKER INFORMATION

Circuit Breaker Prefix	Continuous Ampere Rating	Maximum AC Voltage	Number of Poles
KA/KH	110-150	600	2, 3

This curve is to be used for application and coordination purposes only. The **EZ-AMP™** overlay feature at the bottom of the page should be used during coordination studies.

All time/current characteristic curve data is based on 40°C ambient cold start. Terminations are made with conductors of appropriate length and ratings.

Tripping curves for coordination studies are available upon request.

Curve No. 0655TC8502  
Drawing No. B48095-655-02

# Thermal-Magnetic / Magnetic Only Molded Case Circuit Breakers 225 / 250 Ampere Frame

06013058

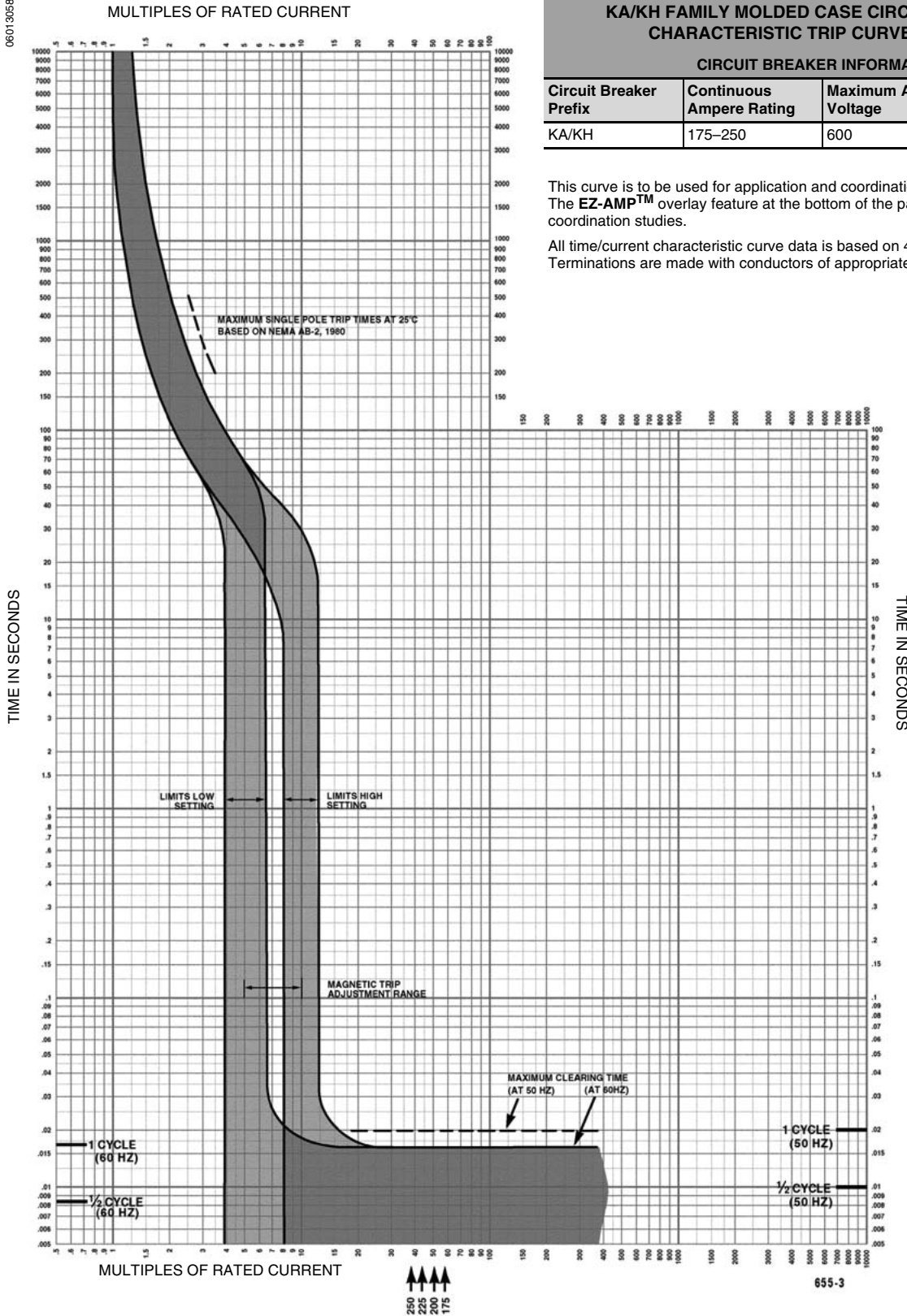

## KA/KH FAMILY MOLDED CASE CIRCUIT BREAKERS CHARACTERISTIC TRIP CURVE NO. 655-3

CIRCUIT BREAKER INFORMATION			
Circuit Breaker Prefix	Continuous Ampere Rating	Maximum AC Voltage	Number of Poles
KA/KH	175-250	600	2, 3

This curve is to be used for application and coordination purposes only. The **EZ-AMP™** overlay feature at the bottom of the page should be used during coordination studies.

All time/current characteristic curve data is based on 40°C ambient cold start. Terminations are made with conductors of appropriate length and ratings.

Tripping curves for coordination studies are available upon request.

Curve No. 0655TC8803  
Drawing No. B48095-655-03

# Thermal-Magnetic / Magnetic Only Molded Case Circuit Breakers 225 / 250 Ampere Frame

06013059

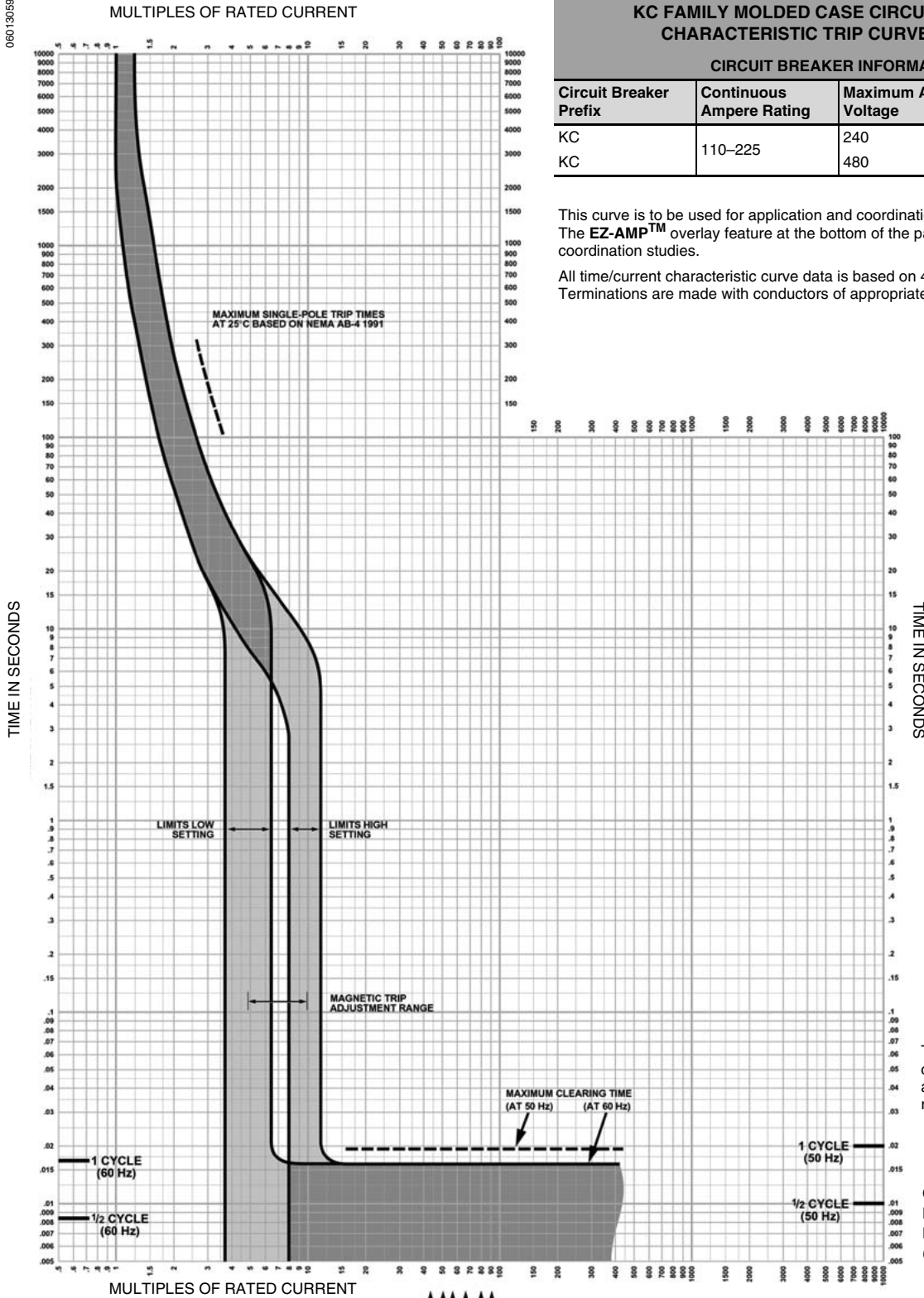

KC FAMILY MOLDED CASE CIRCUIT BREAKERS CHARACTERISTIC TRIP CURVE NO. 655-4			
CIRCUIT BREAKER INFORMATION			
Circuit Breaker Prefix	Continuous Ampere Rating	Maximum AC Voltage	Number of Poles
KC	110-225	240	2, 3
KC		480	

This curve is to be used for application and coordination purposes only. The **EZ-AMP™** overlay feature at the bottom of the page should be used during coordination studies.

All time/current characteristic curve data is based on 40°C ambient cold start. Terminations are made with conductors of appropriate length and ratings.

Tripping curves for coordination studies are available upon request.

Curve No. 0655TC0004  
December 2000  
Drawing No. B48095-655-04  
(Replaces 0655TC8904)

↑ 225  
↑ 200  
↑ 175  
↑ 150  
↑ 125  
↑ 110

655-4

# Thermal-Magnetic / Magnetic Only Molded Case Circuit Breakers 225 / 250 Ampere Frame

KC FAMILY MOLDED CASE CIRCUIT BREAKERS CHARACTERISTIC TRIP CURVE NO. 655-5			
CIRCUIT BREAKER INFORMATION			
Circuit Breaker Prefix	Continuous Ampere Rating	Maximum AC Voltage	Number of Poles
KC	250	240	2, 3
KC		480	2, 3

This curve is to be used for application and coordination purposes only. The **EZ-AMP™** overlay feature at the bottom of the page should be used during coordination studies.

All time/current characteristic curve data is based on 40°C ambient cold start. Terminations are made with conductors of appropriate length and ratings.

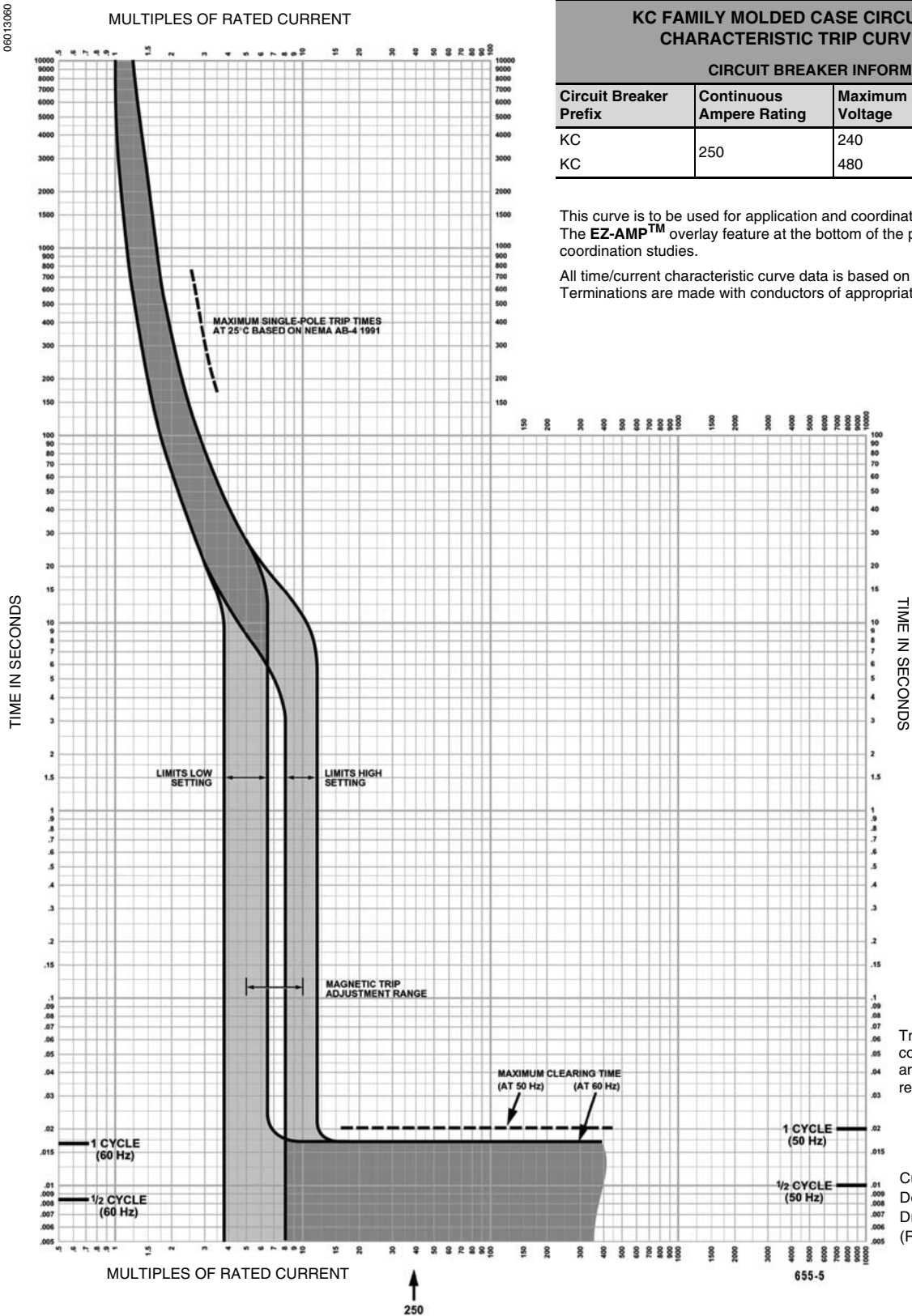

Tripping curves for coordination studies are available upon request.

Curve No. 0655TC0005  
December 2000  
Drawing No. B48095-655-05  
(Replaces 0655TC8905)

# Thermal-Magnetic / Magnetic Only Molded Case Circuit Breakers 225 / 250 Ampere Frame

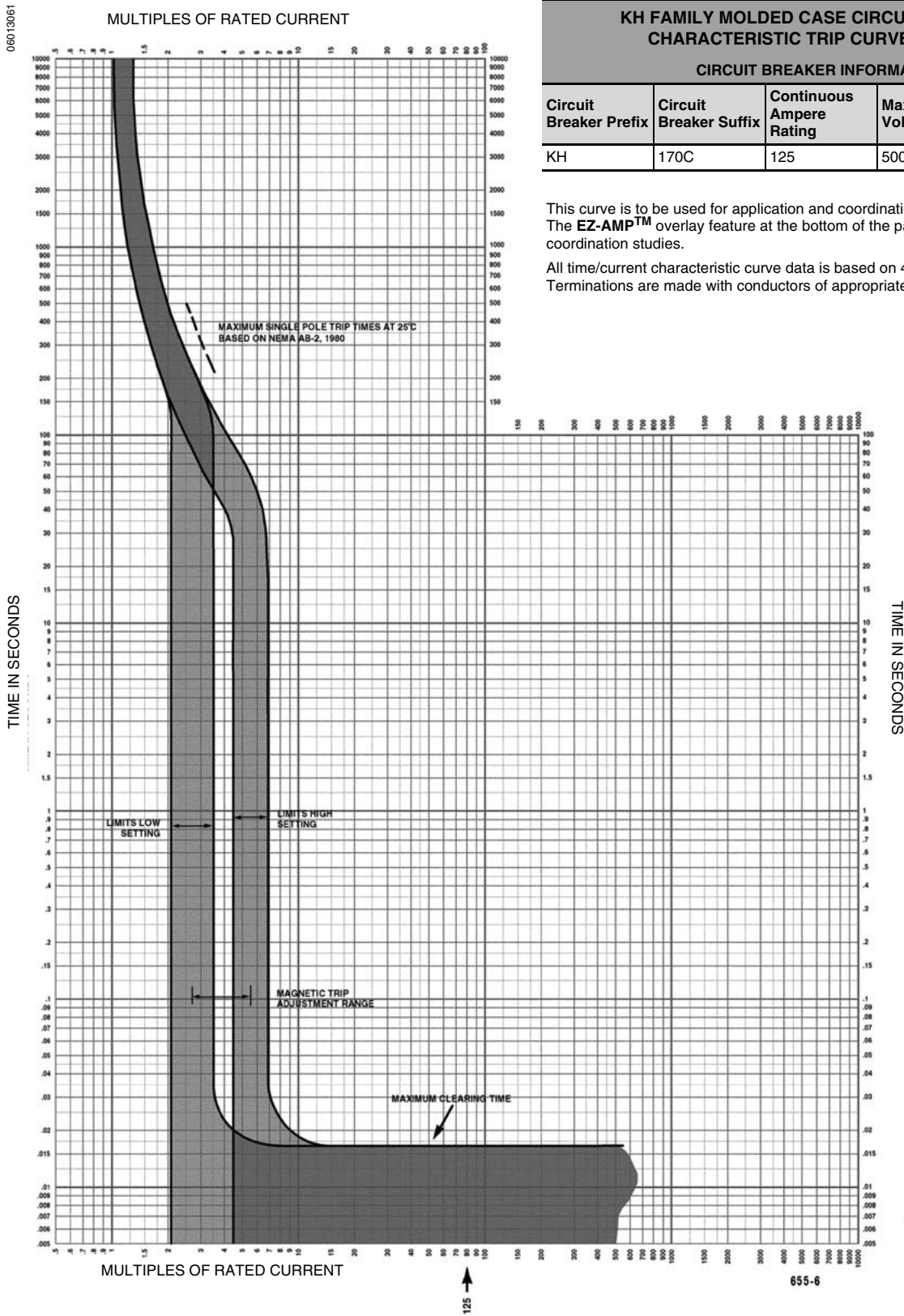

KH FAMILY MOLDED CASE CIRCUIT BREAKERS CHARACTERISTIC TRIP CURVE NO. 655-6				
CIRCUIT BREAKER INFORMATION				
Circuit Breaker Prefix	Circuit Breaker Suffix	Continuous Ampere Rating	Maximum AC Voltage	Number of Poles
KH	170C	125	500	3

This curve is to be used for application and coordination purposes only. The EZ-AMP™ overlay feature at the bottom of the page should be used during coordination studies.

All time/current characteristic curve data is based on 40°C ambient cold start. Terminations are made with conductors of appropriate length and ratings.

Tripping curves for coordination studies are available upon request.

Curve No. 0655TC8906  
Drawing No. B48095-655-06

# Thermal-Magnetic / Magnetic Only Molded Case Circuit Breakers 225 / 250 Ampere Frame

06013062

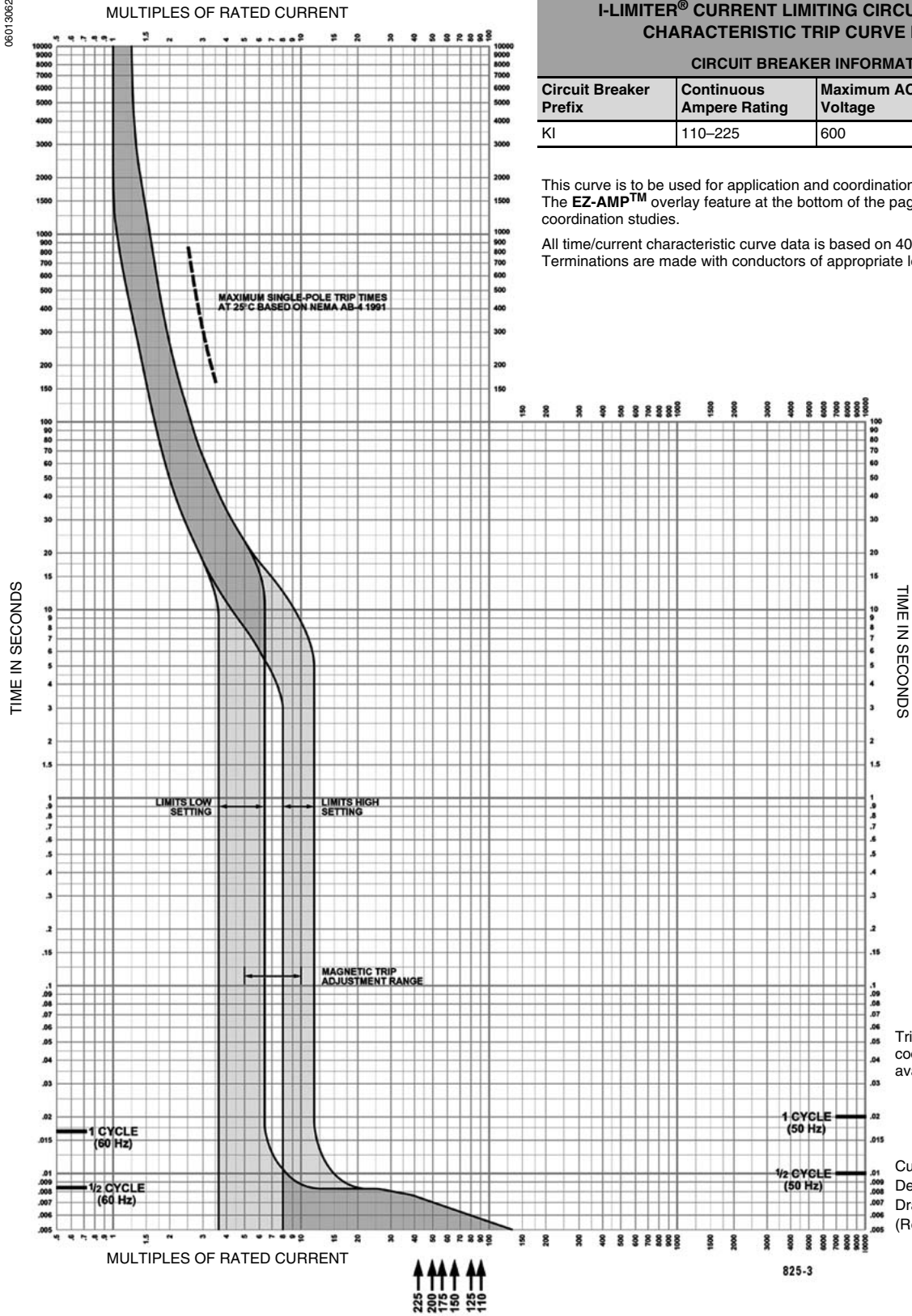

## I-LIMITER® CURRENT LIMITING CIRCUIT BREAKERS CHARACTERISTIC TRIP CURVE NO. 825-3

### CIRCUIT BREAKER INFORMATION

Circuit Breaker Prefix	Continuous Ampere Rating	Maximum AC Voltage	Number of Poles
KI	110-225	600	2, 3

This curve is to be used for application and coordination purposes only. The EZ-AMP™ overlay feature at the bottom of the page should be used during coordination studies.

All time/current characteristic curve data is based on 40°C ambient cold start. Terminations are made with conductors of appropriate length and ratings.

Tripping curves for coordination studies are available upon request.

Curve No. 0825TC0003  
December 2000  
Drawing No. B48095-825-03  
(Replaces 0825TC8503)

# Thermal-Magnetic / Magnetic Only Molded Case Circuit Breakers 225 / 250 Ampere Frame

06019063

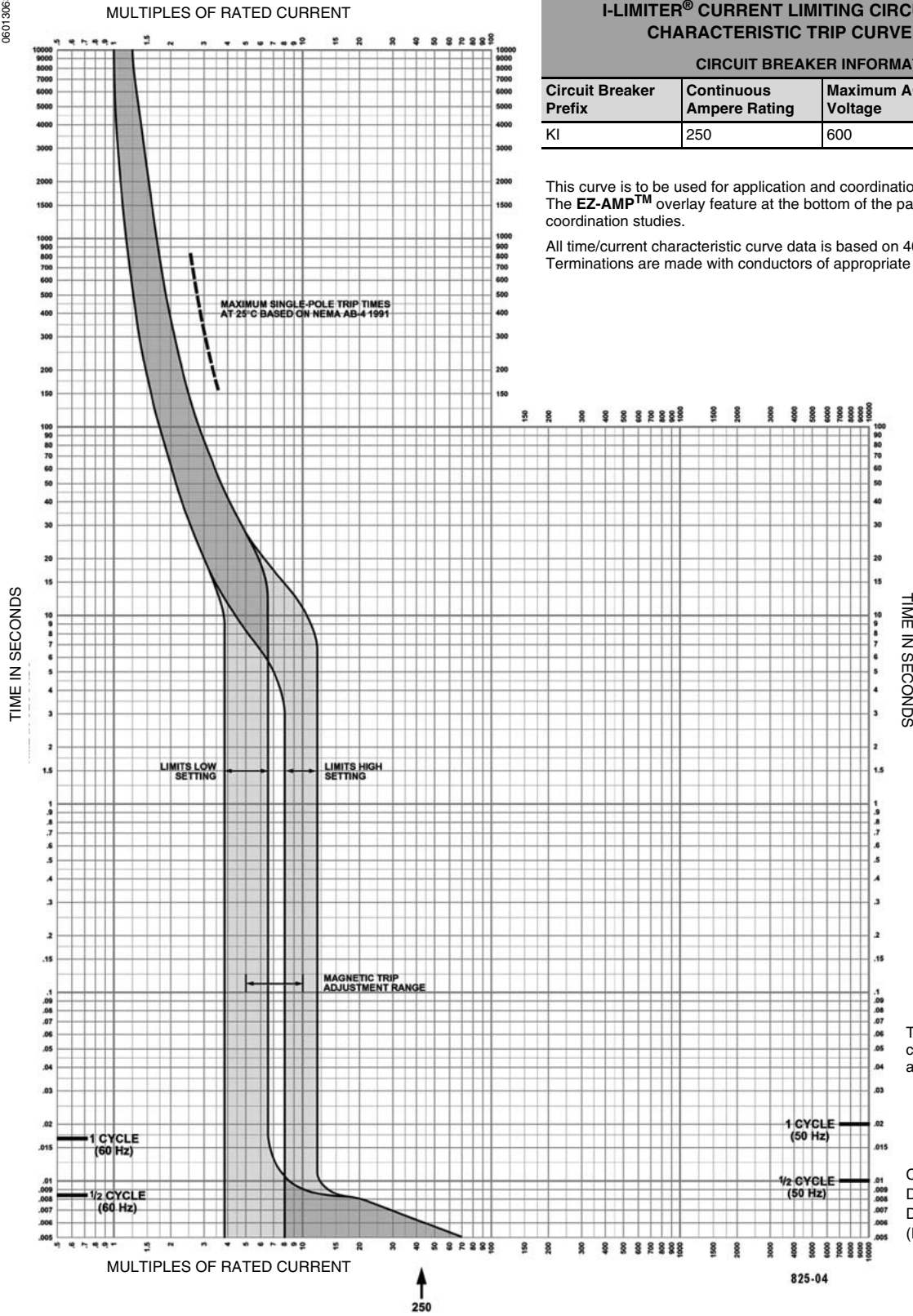

## I-LIMITER® CURRENT LIMITING CIRCUIT BREAKERS CHARACTERISTIC TRIP CURVE NO. 825-4

CIRCUIT BREAKER INFORMATION			
Circuit Breaker Prefix	Continuous Ampere Rating	Maximum AC Voltage	Number of Poles
KI	250	600	2, 3

This curve is to be used for application and coordination purposes only. The EZ-AMP™ overlay feature at the bottom of the page should be used during coordination studies.

All time/current characteristic curve data is based on 40°C ambient cold start. Terminations are made with conductors of appropriate length and ratings.

Tripping curves for coordination studies are available upon request.

Curve No. 0825TC0004  
December 2000  
Drawing No. B48095-825-04  
(Replaces 0825TC8504)

# Thermal-Magnetic / Magnetic Only Molded Case Circuit Breakers 225 / 250 Ampere Frame

## Powerpack® Tripping Curves

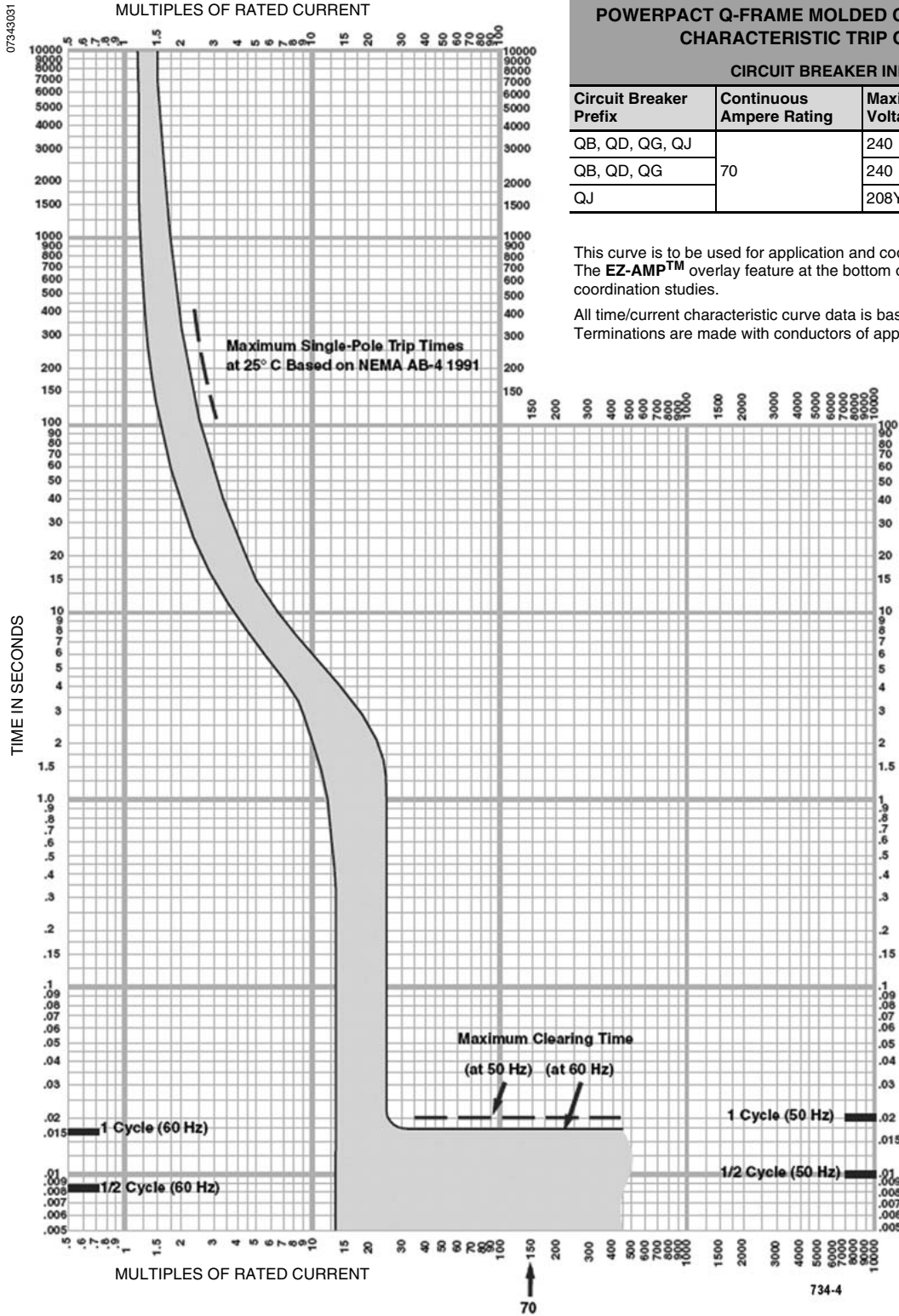

POWERPACK Q-FRAME MOLDED CASE CIRCUIT BREAKERS CHARACTERISTIC TRIP CURVE NO. 734-4			
CIRCUIT BREAKER INFORMATION			
Circuit Breaker Prefix	Continuous Ampere Rating	Maximum AC Voltage	Number of Poles
QB, QD, QG, QJ	70	240	2
QB, QD, QG		240	3
QJ		208Y/120	3

This curve is to be used for application and coordination purposes only. The EZ-AMP™ overlay feature at the bottom of the page should be used during coordination studies.

All time/current characteristic curve data is based on 40°C ambient cold start. Terminations are made with conductors of appropriate length and ratings.

Tripping curves for coordination studies are available upon request.

# Thermal-Magnetic / Magnetic Only Molded Case Circuit Breakers 225 / 250 Ampere Frame

07343032

## POWERPACT® Q-FRAME MOLDED CASE CIRCUIT BREAKERS CHARACTERISTIC TRIP CURVE NO. 734-5

### CIRCUIT BREAKER INFORMATION

Circuit Breaker Prefix	Continuous Ampere Rating	Maximum AC Voltage	Number of Poles
QB, QD, QG, QJ	80	240	2
QB, QD, QG		240	3
QJ		208Y/120	3

This curve is to be used for application and coordination purposes only. The EZ-AMP™ overlay feature at the bottom of the page should be used during coordination studies.

All time/current characteristic curve data is based on 40°C ambient cold start. Terminations are made with conductors of appropriate length and ratings.

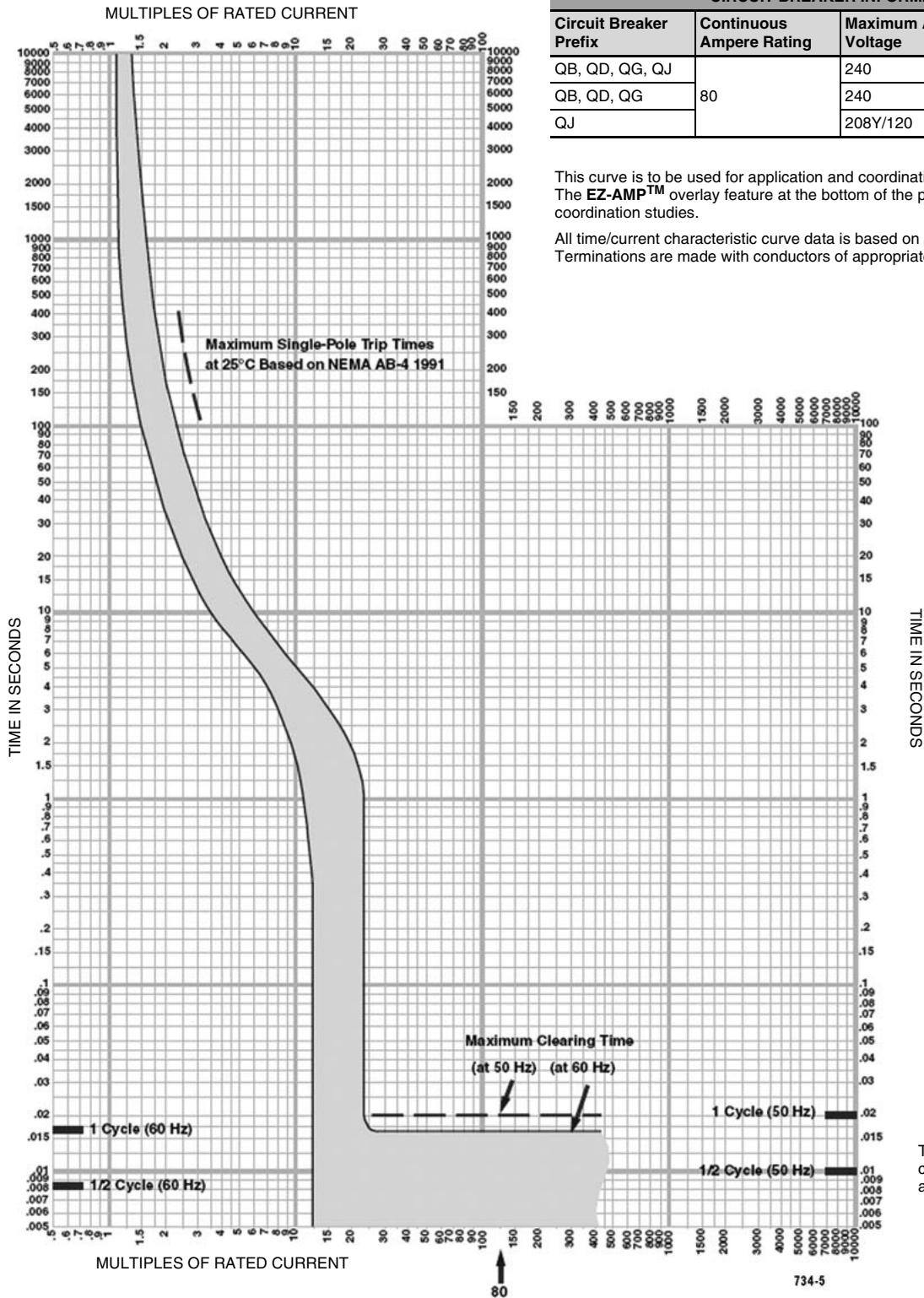

TIME IN SECONDS

Tripping curves for coordination studies are available upon request.

# Thermal-Magnetic / Magnetic Only Molded Case Circuit Breakers 225 / 250 Ampere Frame

07543033

POWERPACT® Q-FRAME MOLDED CASE CIRCUIT BREAKERS CHARACTERISTIC TRIP CURVE NO. 734-6			
CIRCUIT BREAKER INFORMATION			
Circuit Breaker Prefix	Continuous Ampere Rating	Maximum AC Voltage	Number of Poles
QB, QD, QG, QJ	90	240	2
QB, QD, QG		240	3
QJ		208Y/120	3

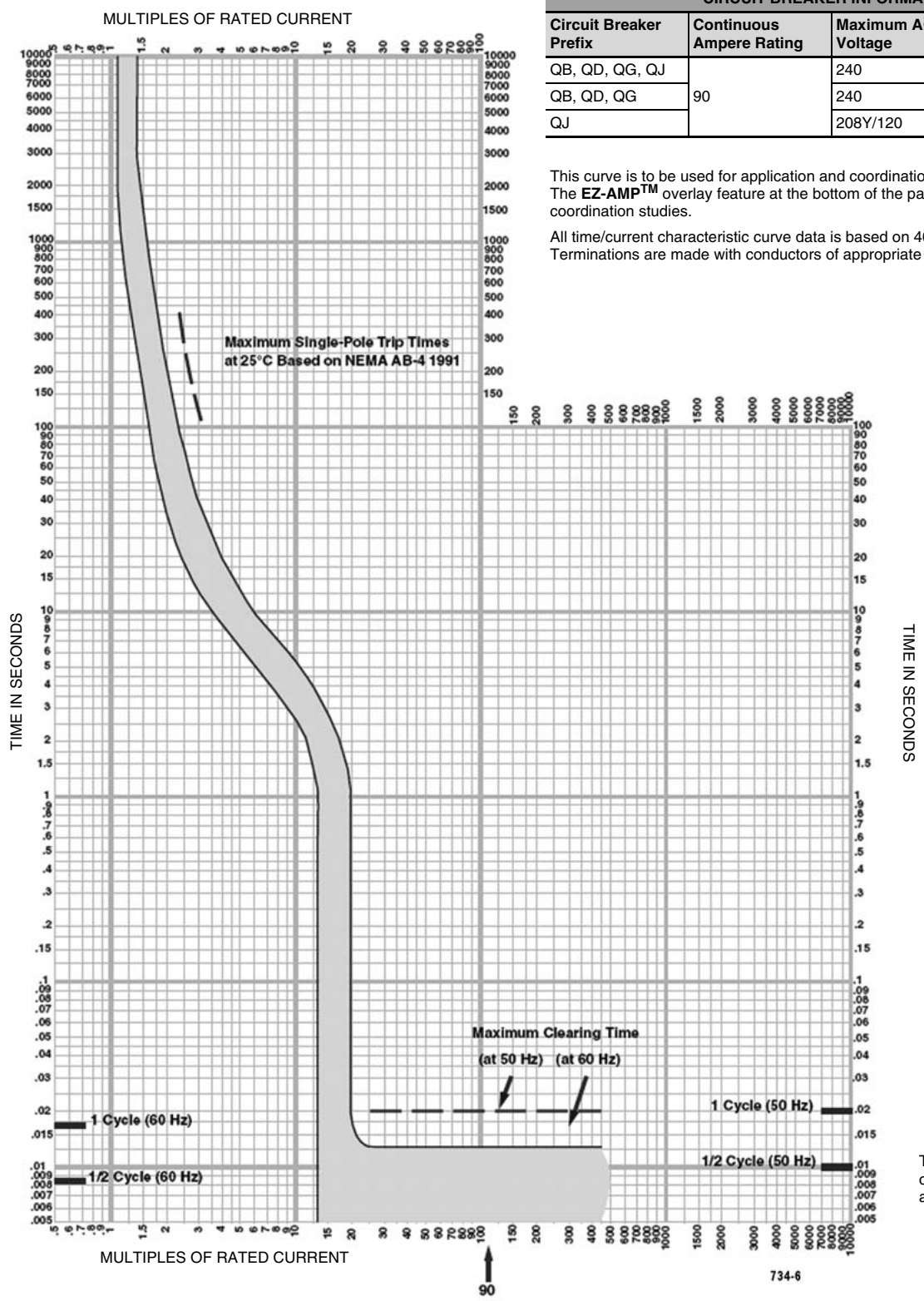

This curve is to be used for application and coordination purposes only. The EZ-AMP™ overlay feature at the bottom of the page should be used during coordination studies.

All time/current characteristic curve data is based on 40°C ambient cold start. Terminations are made with conductors of appropriate length and ratings.

Tripping curves for coordination studies are available upon request.

# Thermal-Magnetic / Magnetic Only Molded Case Circuit Breakers 225 / 250 Ampere Frame

07349034

## POWERPACT® Q-FRAME MOLDED CASE CIRCUIT BREAKERS CHARACTERISTIC TRIP CURVE NO. 734-7

### CIRCUIT BREAKER INFORMATION

Circuit Breaker Prefix	Continuous Ampere Rating	Maximum AC Voltage	Number of Poles
QB, QD, QG, QJ	100	240	2
QB, QD, QG		240	3
QJ		208Y/120	3

This curve is to be used for application and coordination purposes only. The EZ-AMP™ overlay feature at the bottom of the page should be used during coordination studies.

All time/current characteristic curve data is based on 40°C ambient cold start. Terminations are made with conductors of appropriate length and ratings.

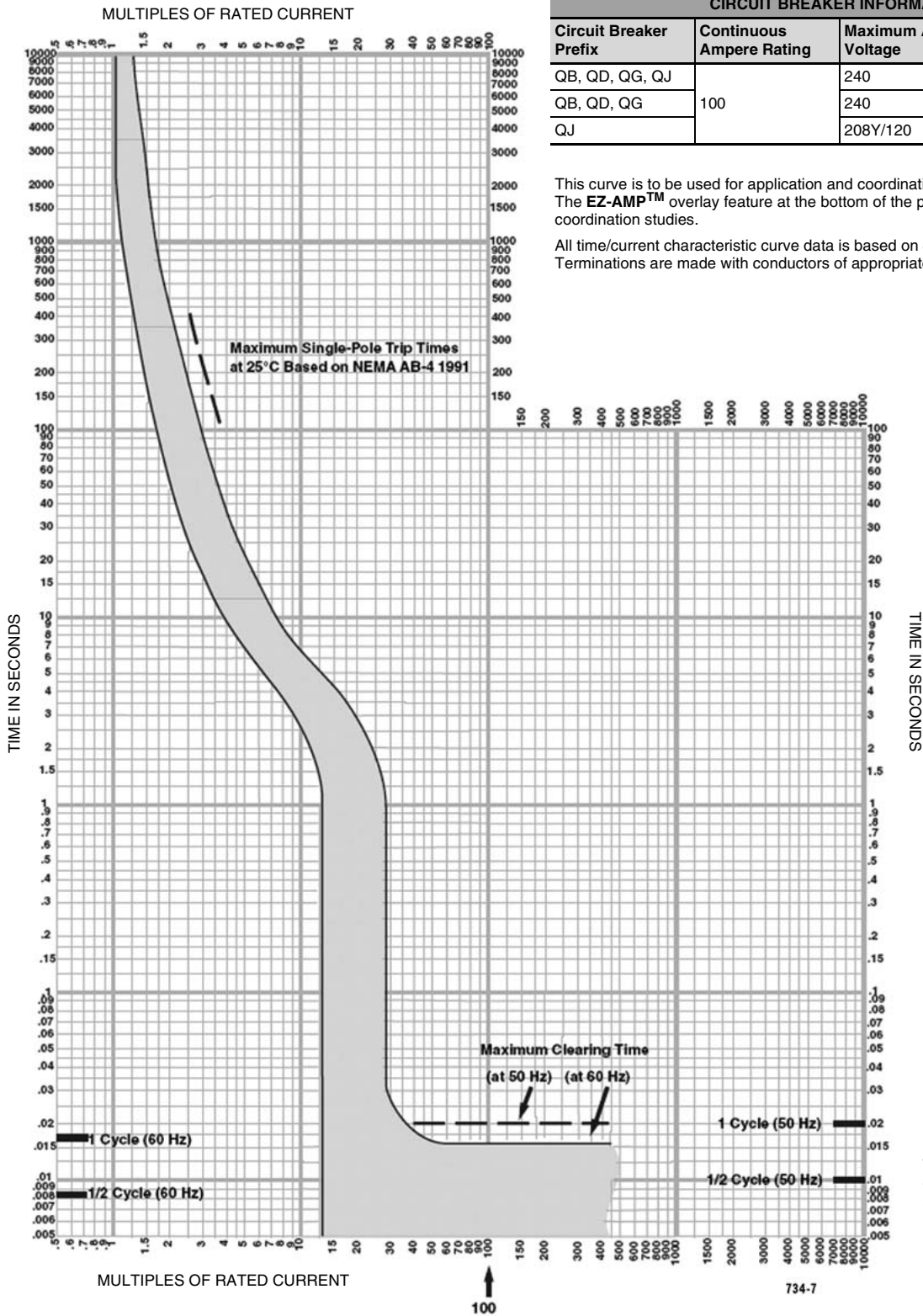

Tripping curves for coordination studies are available upon request.

# Thermal-Magnetic / Magnetic Only Molded Case Circuit Breakers 225 / 250 Ampere Frame

07343035

## POWERPACT® Q-FRAME MOLDED CASE CIRCUIT BREAKERS CHARACTERISTIC TRIP CURVE NO. 734-8

### CIRCUIT BREAKER INFORMATION

Circuit Breaker Prefix	Continuous Ampere Rating	Maximum AC Voltage	Number of Poles
QB, QD, QG, QJ	110-150	240	2
QB, QD, QG		240	3
QJ		208Y/120	3

This curve is to be used for application and coordination purposes only. The EZ-AMP™ overlay feature at the bottom of the page should be used during coordination studies.

All time/current characteristic curve data is based on 40°C ambient cold start. Terminations are made with conductors of appropriate length and ratings.

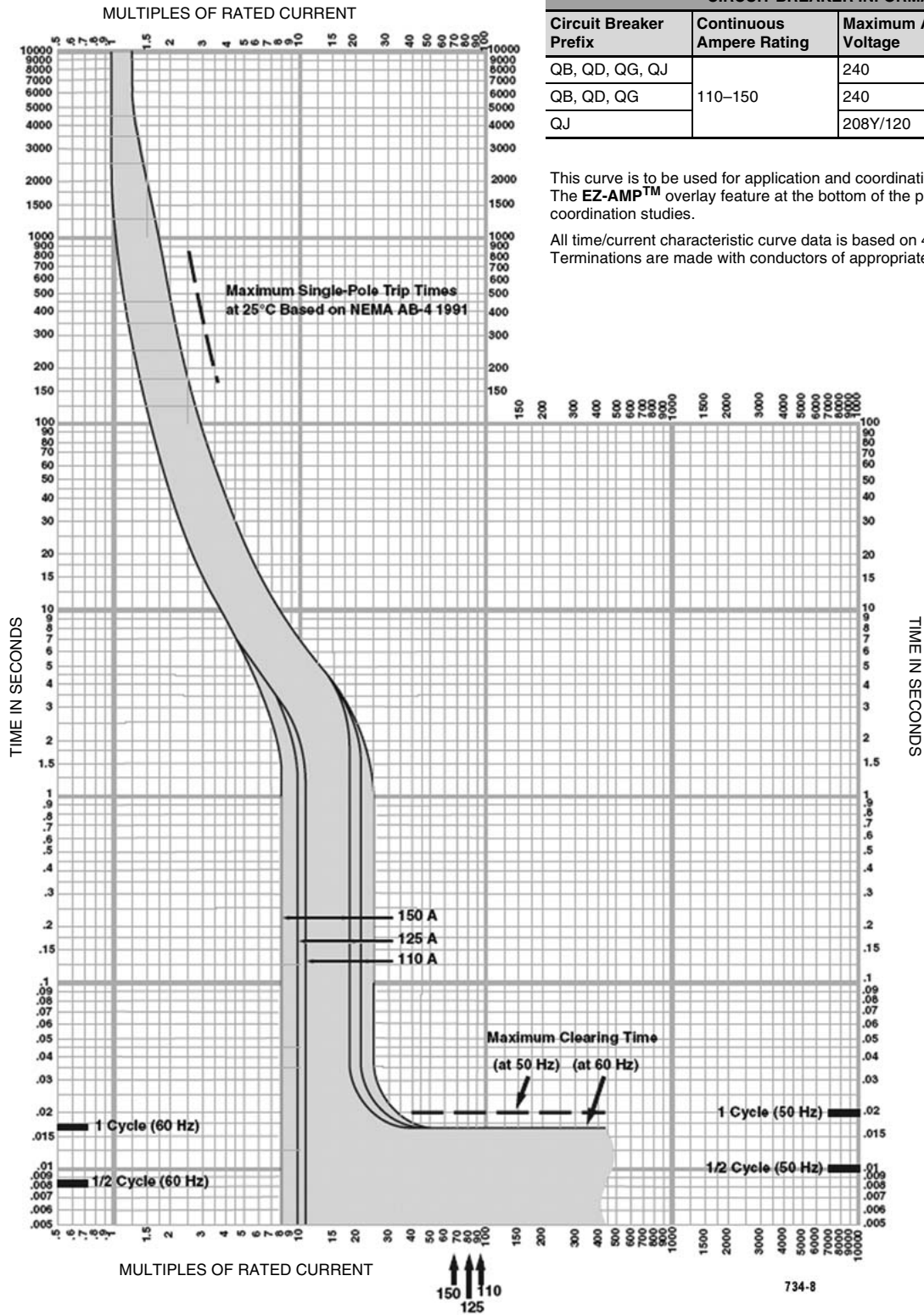

Tripping curves for coordination studies are available upon request.

# Thermal-Magnetic / Magnetic Only Molded Case Circuit Breakers 225 / 250 Ampere Frame

07343036

POWERPACT® Q-FRAME MOLDED CASE CIRCUIT BREAKERS CHARACTERISTIC TRIP CURVE NO. 734-9			
CIRCUIT BREAKER INFORMATION			
Circuit Breaker Prefix	Continuous Ampere Rating	Maximum AC Voltage	Number of Poles
QB, QD, QG, QJ	175-225	240	2
QB, QD, QG		240	3
QJ		208Y/120	3

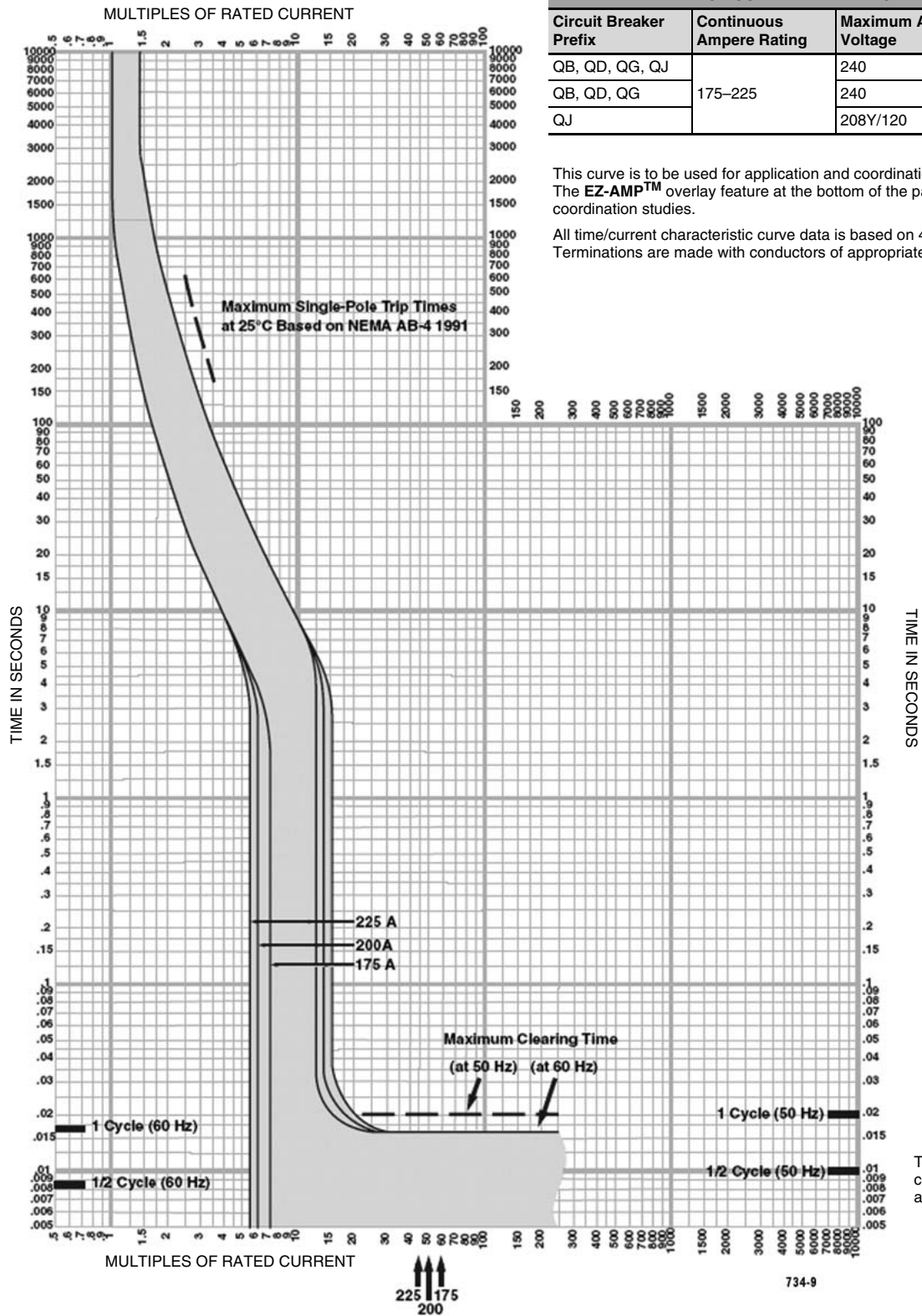

This curve is to be used for application and coordination purposes only. The EZ-AMP™ overlay feature at the bottom of the page should be used during coordination studies.

All time/current characteristic curve data is based on 40°C ambient cold start. Terminations are made with conductors of appropriate length and ratings.

Tripping curves for coordination studies are available upon request.

# Thermal-Magnetic / Magnetic Only Molded Case Circuit Breakers 225 / 250 Ampere Frame

07949037

POWERPACT® Q-FRAME MOLDED CASE CIRCUIT BREAKERS CHARACTERISTIC TRIP CURVE NO. 734-10			
CIRCUIT BREAKER INFORMATION			
Circuit Breaker Prefix	Continuous Ampere Rating	Maximum AC Voltage	Number of Poles
QB, QD, QG, QJ	250	240	2
QB, QD, QG		240	3
QJ		208Y/120	3

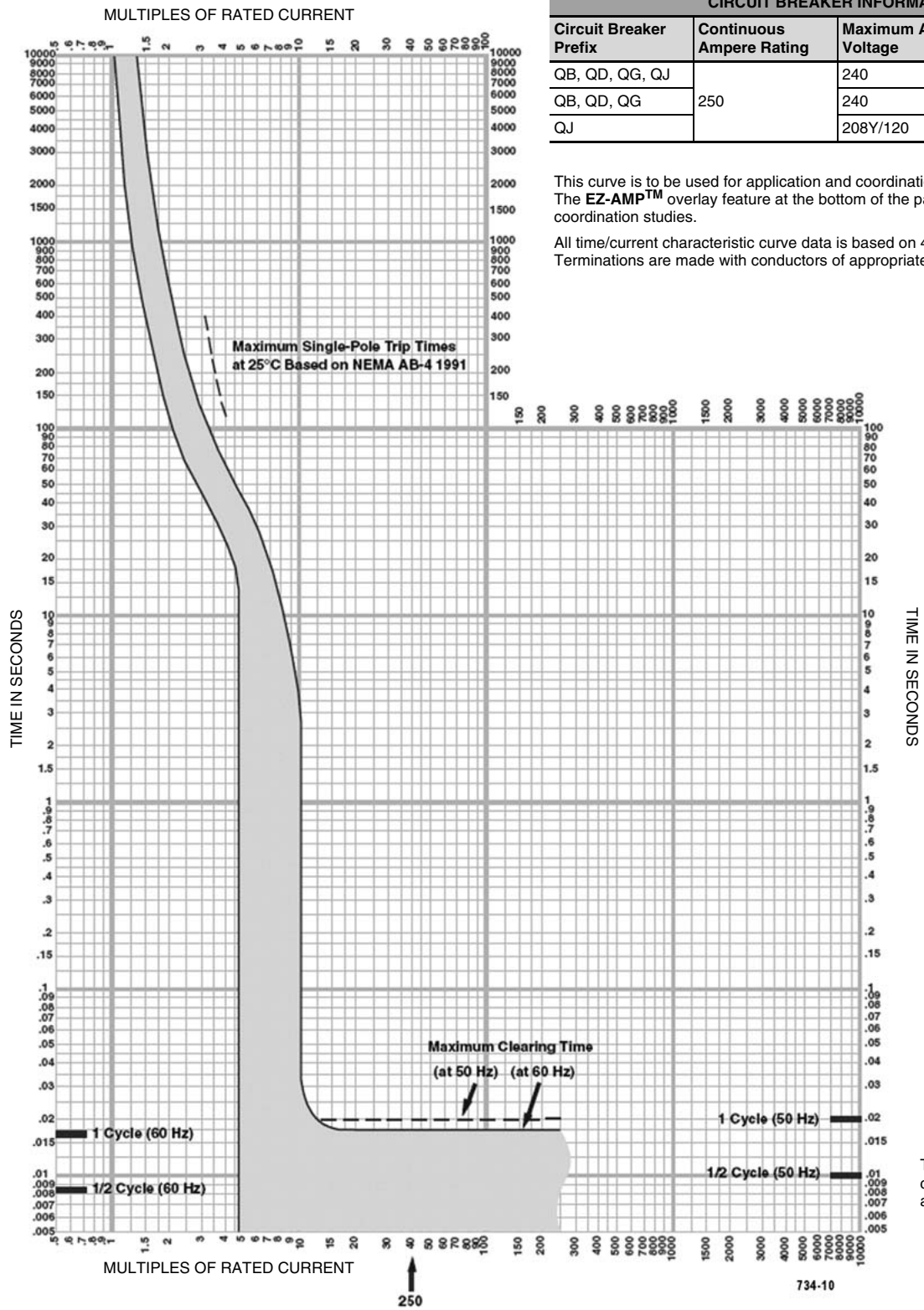

This curve is to be used for application and coordination purposes only. The EZ-AMP™ overlay feature at the bottom of the page should be used during coordination studies.

All time/current characteristic curve data is based on 40°C ambient cold start. Terminations are made with conductors of appropriate length and ratings.

Tripping curves for coordination studies are available upon request.

# Thermal-Magnetic / Magnetic Only Molded Case Circuit Breakers 225 / 250 Ampere Frame

06113485

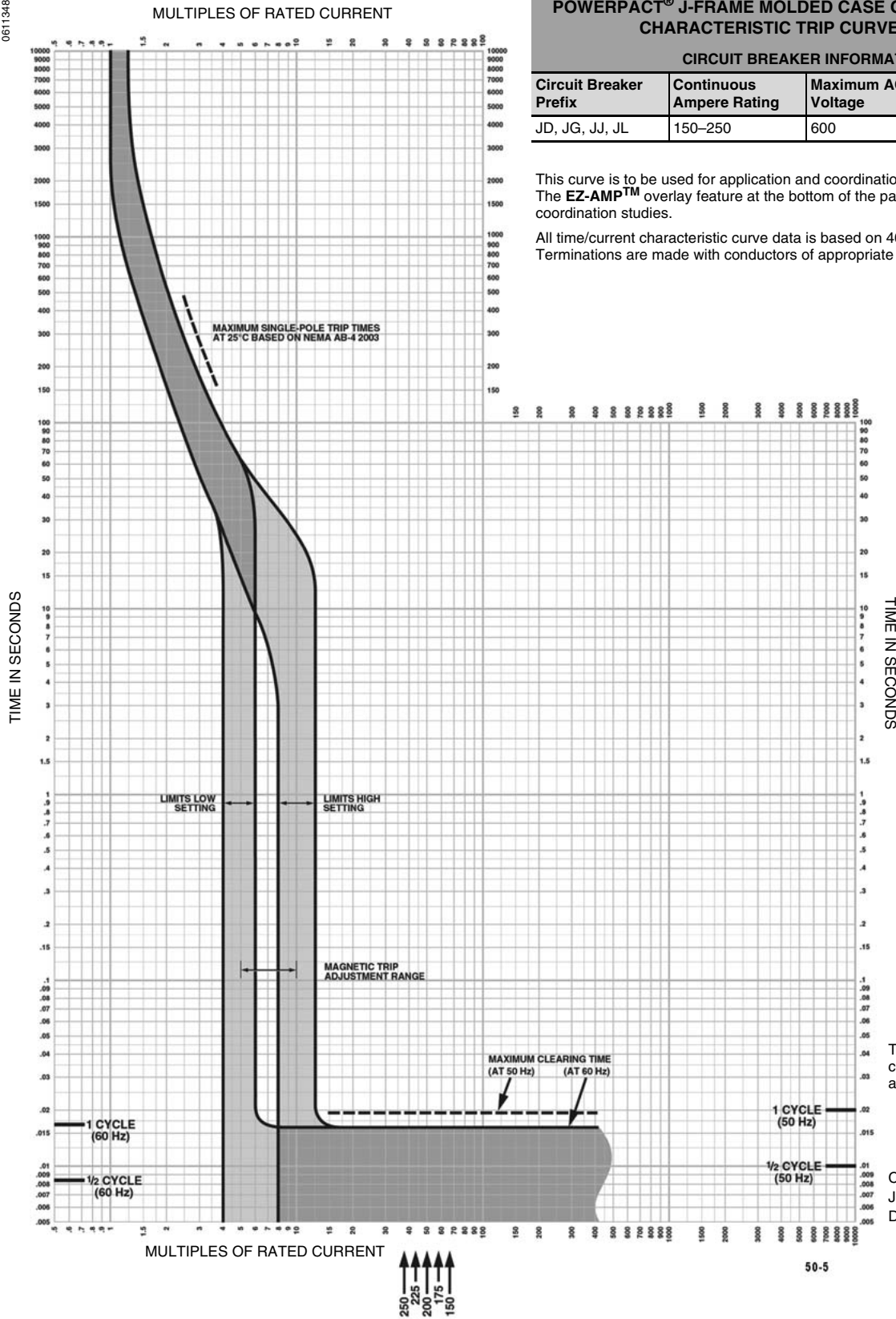

## POWERPACT® J-FRAME MOLDED CASE CIRCUIT BREAKERS CHARACTERISTIC TRIP CURVE NO. 50-5

CIRCUIT BREAKER INFORMATION			
Circuit Breaker Prefix	Continuous Ampere Rating	Maximum AC Voltage	Number of Poles
JD, JG, JJ, JL	150-250	600	2, 3

This curve is to be used for application and coordination purposes only. The EZ-AMP™ overlay feature at the bottom of the page should be used during coordination studies.

All time/current characteristic curve data is based on 40°C ambient cold start. Terminations are made with conductors of appropriate length and ratings.

Tripping curves for coordination studies are available upon request.

Curve No. 0050TC0405  
June 2004  
Drawing No. B48095-050-05

# Thermal-Magnetic / Magnetic Only Molded Case Circuit Breakers 225 / 250 Ampere Frame

## Let-through Curves

**I-LIMITER® CURRENT LIMITING CIRCUIT BREAKERS**  
**KI 250 Ampere Frame at 240, 480 and 600 Vac, 3Ø**  
**110–250 Amperes**  
**Curve No. 825-1 Peak Let-Through Current  $I_p$**   
**and 825-2 Let-Through  $I^2t$**

06013064

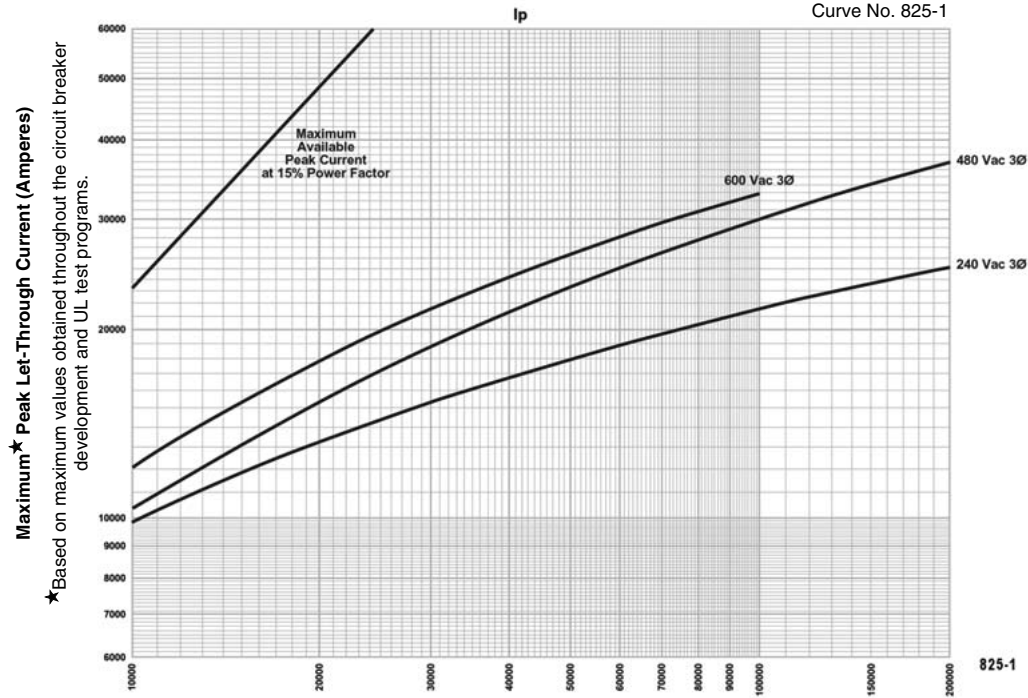

06013065

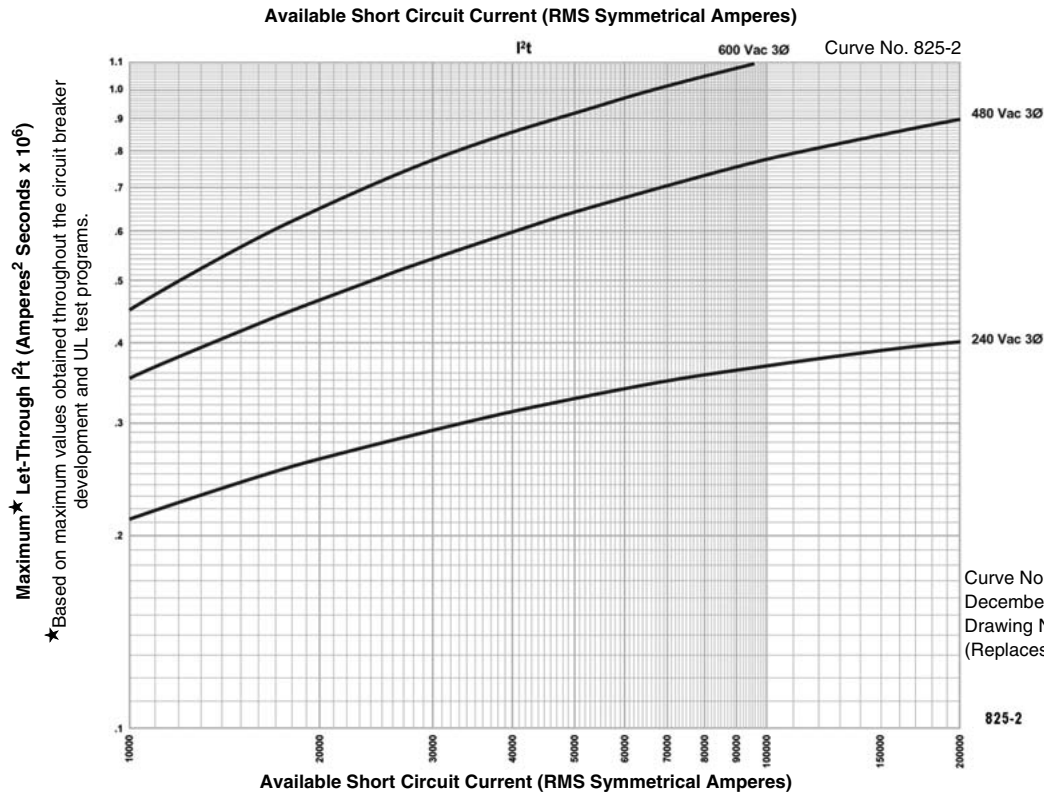

Curve No. 0825TC0002  
 December 2000  
 Drawing No. B48095-825-02  
 (Replaces 0825TC8502R9/96)

# Thermal-Magnetic / Magnetic Only Molded Case Circuit Breakers 225 / 250 Ampere Frame

## I-LIMITER® CURRENT LIMITING CIRCUIT BREAKERS KI Series 2 250 Ampere Frame at 240, 480 and 600 Vac, 3Ø 110–250 Amperes

### Curve No. 825-5 Peak Let-Through Current $I_p$ and 825-6 Let-Through $I^2t$

06013066

**Maximum\* Peak Let-Through Current (Amperes)**

\*Based on maximum values obtained throughout the circuit breaker development and UL test programs.

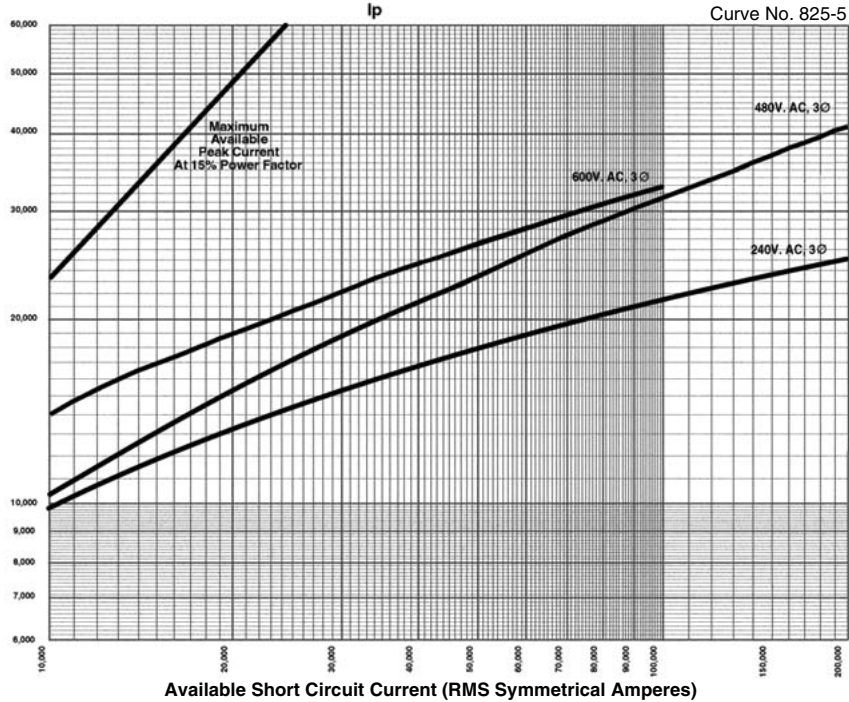

825-5

06013067

**Maximum\* Let-Through  $I^2t$  (Amperes<sup>2</sup> Seconds x 10<sup>6</sup>)**

\*Based on maximum values obtained throughout the circuit breaker development and UL test programs.

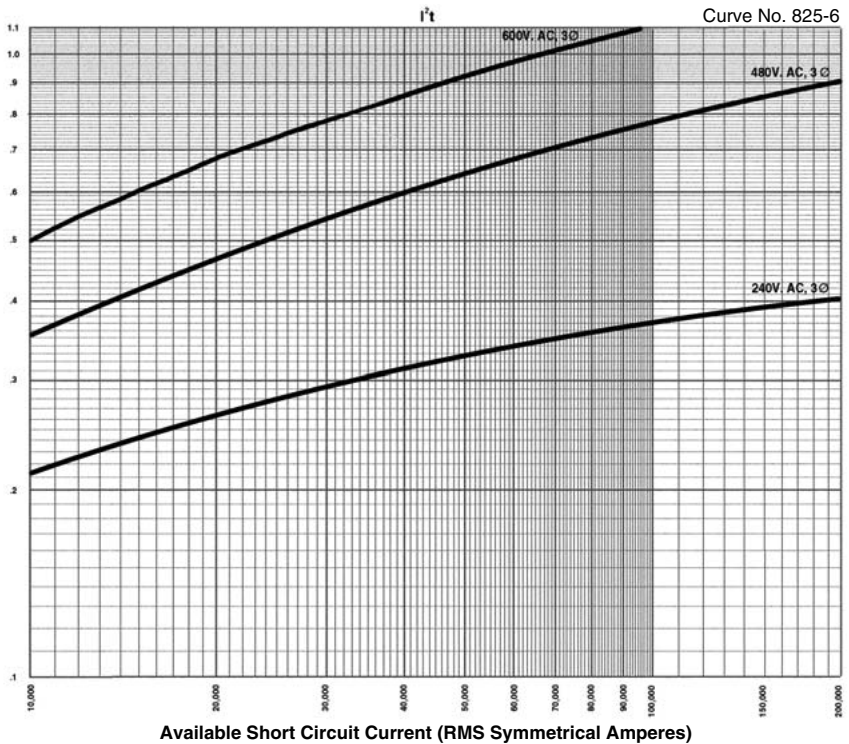

Curve No. 0825TC9601  
Drawing No. B48095-825-06

825-6

# Thermal-Magnetic / Magnetic Only Molded Case Circuit Breakers 225 / 250 Ampere Frame

## Powerpack® Let-through Curves

**POWERPACT J-FRAME CIRCUIT BREAKERS**  
**J-frame 250 Ampere (JD, JG, JJ, and JL)**  
**110–250 Amperes**  
**Curve No. 50-8 Let-Through  $I^2t$**   
**and 50-9 Peak Let-Through Current  $I_p$**

06113486

**Typical\* Let-Through  $I^2t$  (Amperes<sup>2</sup> Seconds x 10<sup>6</sup>)**

\*Based on typical values obtained throughout the circuit breaker development and UL test programs.

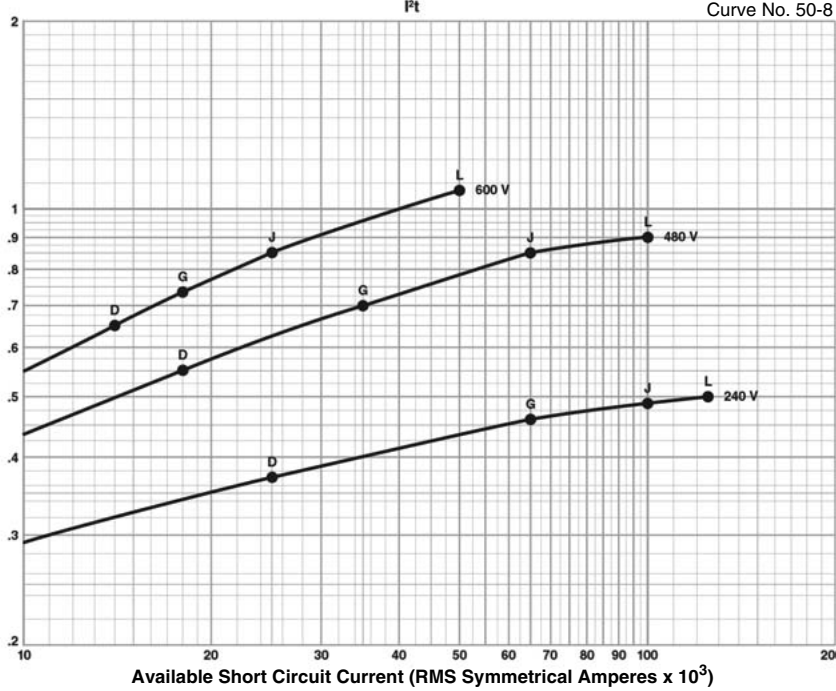

06113487

**Maximum\* Let-Through  $I^2t$  (Amperes Seconds x 10<sup>3</sup>)**

\*Based on maximum values obtained throughout the circuit breaker development and UL test programs.

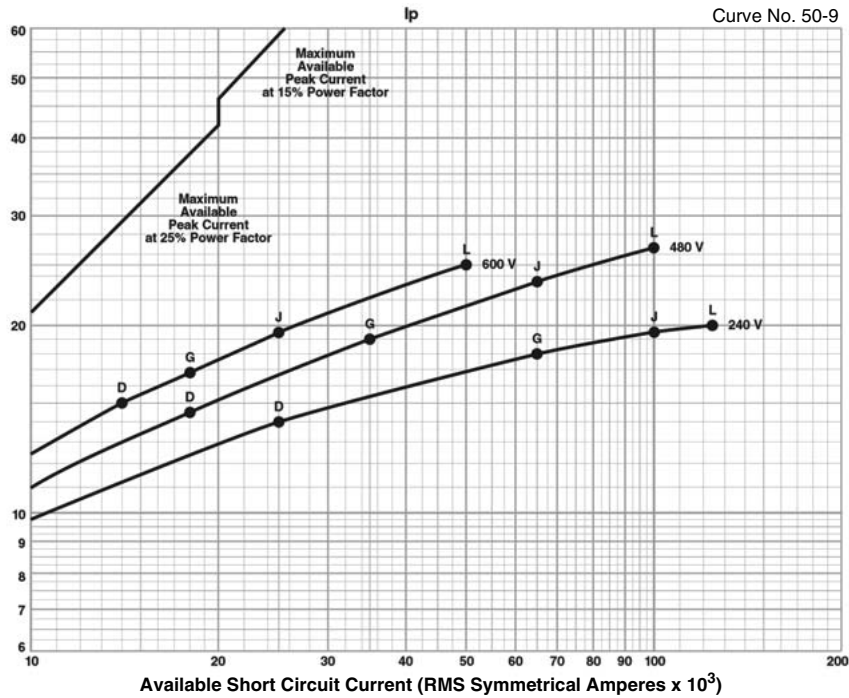

# Thermal-Magnetic / Magnetic Only Molded Case Circuit Breakers 400 Ampere Frame

## 400 AMPERE FRAME

This section provides specific information on Square D® 400 ampere frame thermal-magnetic molded case circuit breakers. For more information, see the Introduction in this catalog.

### Description

**Table 24: Description of 400 Ampere Frame Circuit Breakers**

Circuit Breaker	Description
Q4	250–400 ampere, 240 Vac, 50/60 Hz, 2- and 3-pole
LA/LH	125–400 ampere, 600 Vac, 50/60 Hz, 250 Vdc, 2- and 3-pole

### Applications

Q4, LA and LH, circuit breakers are used in industrial enclosures, panelboards, switchboards, busway plug-in units, combination starters and motor control centers.

**Table 25: 400 Ampere Frame Interrupting Ratings**

Catalog Number Prefix		No. of Poles	Cont. Ampere Rating	UL Listed Interrupting Rating (kA)							Federal Specs. W-C-375B/GEN	IEC 60947-2 Icu/lcs (kA) AC Voltage	
Unit Mount	I-Line®			AC Volts - RMS Symmetrical Amperes				DC Volts					
				120	240	480Y/277	480	600	125	250	500		380/220
Q4L	Q4	2, 3	250–400	25	25	—	—	—	—	—	—	14b	—
LAL	LA	2, 3	125–400	42	42	30	30	22	10	10	—	21a	20/5
LHL★	LH★	2, 3	125–400	65	65	35	35	25	—	—	—	23a	20/5
LHL-DC▲	—	3	—	—	—	—	—	—	—	—	20	—	—

★ Separate UL rating available for 240 Vac and 480 Vac grounded B single phase systems. Breakers must be ordered with 5861 suffix.

▲ UL Listed 500 Vdc rating for use on ungrounded systems. Must be connected 3 poles in series. Consult your local Square D sales office for additional information 1-888-Square D.

### Selection Data

**Table 26: 400 Ampere Frame Unit Mount Circuit Breakers**

Ampere Rating	AC Magnetic Trip Settings Amperes▲		Two Pole★ Catalog No.	Three Pole Catalog No.	Standard Lug Kit Wire Range
<b>Q4L Standard Interrupting</b>					
	Low	High	240 Vac	240 Vac	
250	1250	2500	Q4L2250	Q4L3250	AL400LA 1-#1-600 kcmil or 2-#1-250 kcmil
300	1500	3000	Q4L2300	Q4L3300	
350	1750	3500	Q4L2350	Q4L3350	
400	2000	4000	Q4L2400	Q4L3400	

*Continued on next page*



**Q4/LA/LH**  
Two- and Three-pole  
6" Mounting Height

## Thermal-Magnetic / Magnetic Only Molded Case Circuit Breakers 400 Ampere Frame

**Table 26: 400 Ampere Frame Unit Mount Circuit Breakers** (continued)

Ampere Rating	AC Magnetic Trip Settings Amperes <sup>▲</sup>		Two Pole <sup>★</sup> Catalog No.	Three Pole Catalog No.	Standard Lug Kit Wire Range
<b>LAL Standard Interrupting</b>					
	Low	High	600 Vac/250 Vdc	600 Vac/250 Vdc	
125	625	1250	LAL26125	LAL36125	AL400LA 1-#1-600 kcmil or 2-#1-250 kcmil
150	750	1500	LAL26150	LAL36150	
175	875	1750	LAL26175	LAL36175	
200	1000	2000	LAL26200	LAL36200	
225	1125	2250	LAL26225	LAL36225	
250	1250	2500	LAL26250	LAL36250	
300	1500	3000	LAL26300	LAL36300	
350	1750	3500	LAL26350	LAL36350	
400	2000	4000	LAL26400	LAL36400	
<b>LHL High Interrupting</b>					
	Low	High	600 Vac/250 Vdc	600 Vac/250 Vdc	
125	625	1250	LHL26125	LHL36125	AL400LA 1-#1-600 kcmil or 2-#1-250 kcmil
150	750	1500	LHL26150	LHL36150	
175	875	1750	LHL26175	LHL36175	
200	1000	2000	LHL26200	LHL36200	
225	1125	2250	LHL26225	LHL36225	
250	1250	2500	LHL26250	LHL36250	
300	1500	3000	LHL26300	LHL36300	
350	1750	3500	LHL26350	LHL36350	
400	2000	4000	LHL26400	LHL36400	



0601 3069

**Q4L/LAL/LHL  
Two- and Three-pole  
125-400 Amperes**

**Table 27: 400 Ampere Frame I-Line<sup>®</sup> Circuit Breakers**

Ampere Rating	AC Magnetic Trip Settings Amperes <sup>▲</sup>		Two Pole <sup>★</sup> Catalog No.	Three Pole Catalog No.	Standard Lug Kit Wire Range
<b>Q4 Standard Interrupting</b>					
	Low	High	240 Vac	240 Vac	
250	1250	2500	Q422250( )	Q432250	AL400LA 1-#1-600 kcmil or 2-#1-250 kcmil
300	1500	3000	Q422300( )	Q432300	
350	1750	3500	Q422350( )	Q432350	
400	2000	4000	Q422400( )	Q432400	
<b>LA Standard Interrupting</b>					
	Low	High	600 Vac/250 Vdc	600 Vac/250 Vdc	
125	625	1250	LA26125( )	LA36125	AL400LA 1-#1-600 kcmil or 2-#1-250 kcmil
150	750	1500	LA26150( )	LA36150	
175	875	1750	LA26175( )	LA36175	
200	1000	2000	LA26200( )	LA36200	
225	1125	2250	LA26225( )	LA36225	
250	1250	2500	LA26250( )	LA36250	
300	1500	3000	LA26300( )	LA36300	
350	1750	3500	LA26350( )	LA36350	
400	2000	4000	LA26400( )	LA36400	

*Continued on next page*

# Thermal-Magnetic / Magnetic Only Molded Case Circuit Breakers 400 Ampere Frame

**Table 27: 400 Ampere Frame I-Line® Circuit Breakers (continued)**

Ampere Rating	AC Magnetic Trip Settings Amperes <sup>▲</sup>		Two Pole <sup>★</sup> Catalog No.	Three Pole Catalog No.	Standard Lug Kit Wire Range
<b>LH High Interrupting</b>					
	Low	High	600 Vac/250 Vdc	600 Vac/250 Vdc	
125	625	1250	LH26125( )	LH36125	
150	750	1500	LH26150( )	LH36150	
175	875	1750	LH26175( )	LH36175	
200	1000	2000	LH26200( )	LH36200	AL400LA
225	1125	2250	LH26225( )	LH36225	1-#1-600 kcmil or
250	1250	2500	LH26250( )	LH36250	2-#1-250 kcmil
300	1500	3000	LH26300( )	LH36300	
350	1750	3500	LH26350( )	LH36350	
400	2000	4000	LH26400( )	LH36400	

<sup>★</sup> Two pole circuit breaker catalog numbers are completed by adding required phase connection letters as a suffix to the catalog number.

<sup>▲</sup> UL magnetic trip setting tolerances are -20% / +30% (Low) and -20% / + 30% (High) from the nominal values shown.

# Thermal-Magnetic / Magnetic Only Molded Case Circuit Breakers 400 Ampere Frame

## Dimensions

Figure 14: Q4L, LAL, LHL 400 Ampere Frame

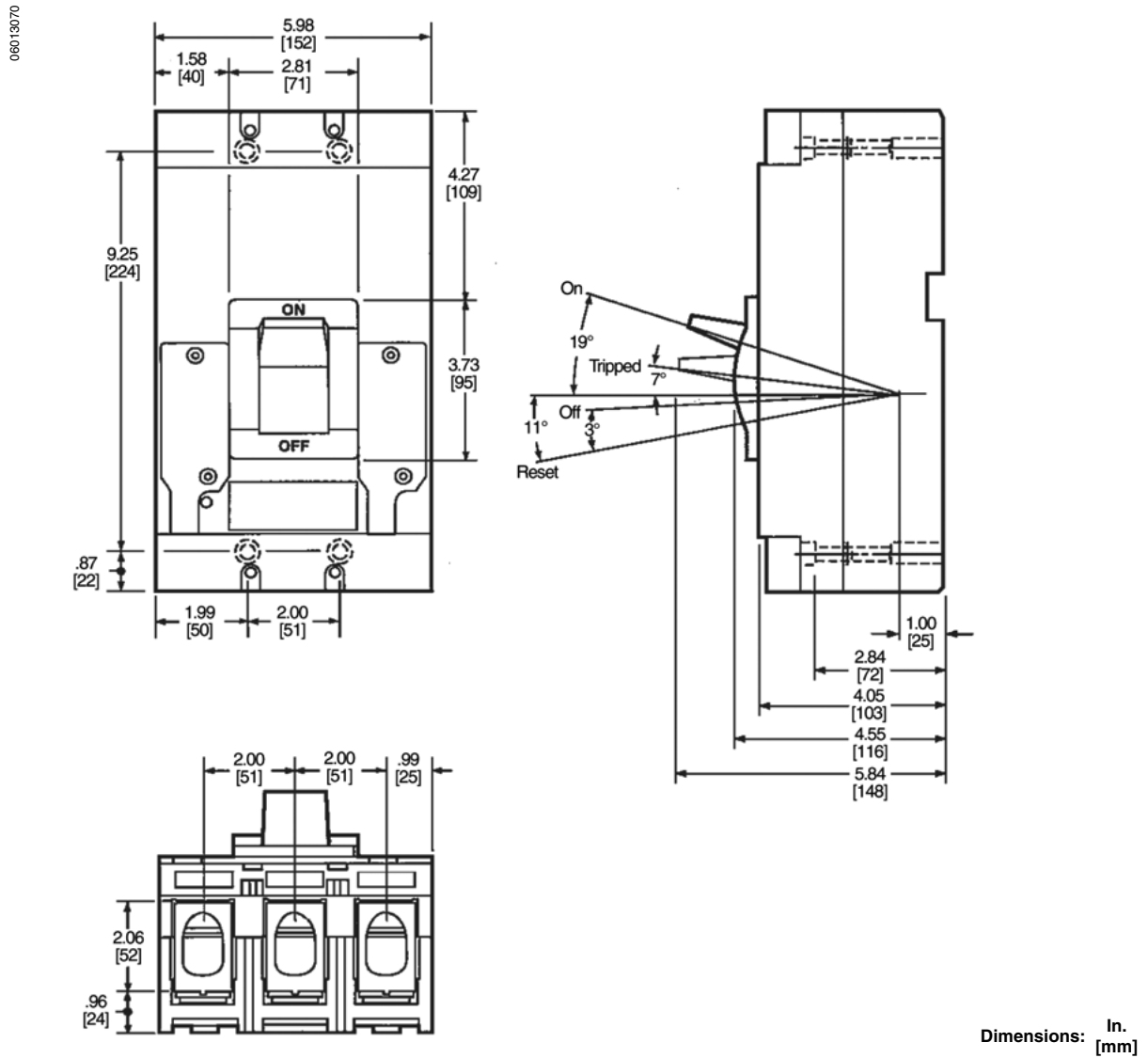

# Thermal-Magnetic / Magnetic Only Molded Case Circuit Breakers 400 Ampere Frame

## Tripping Curves

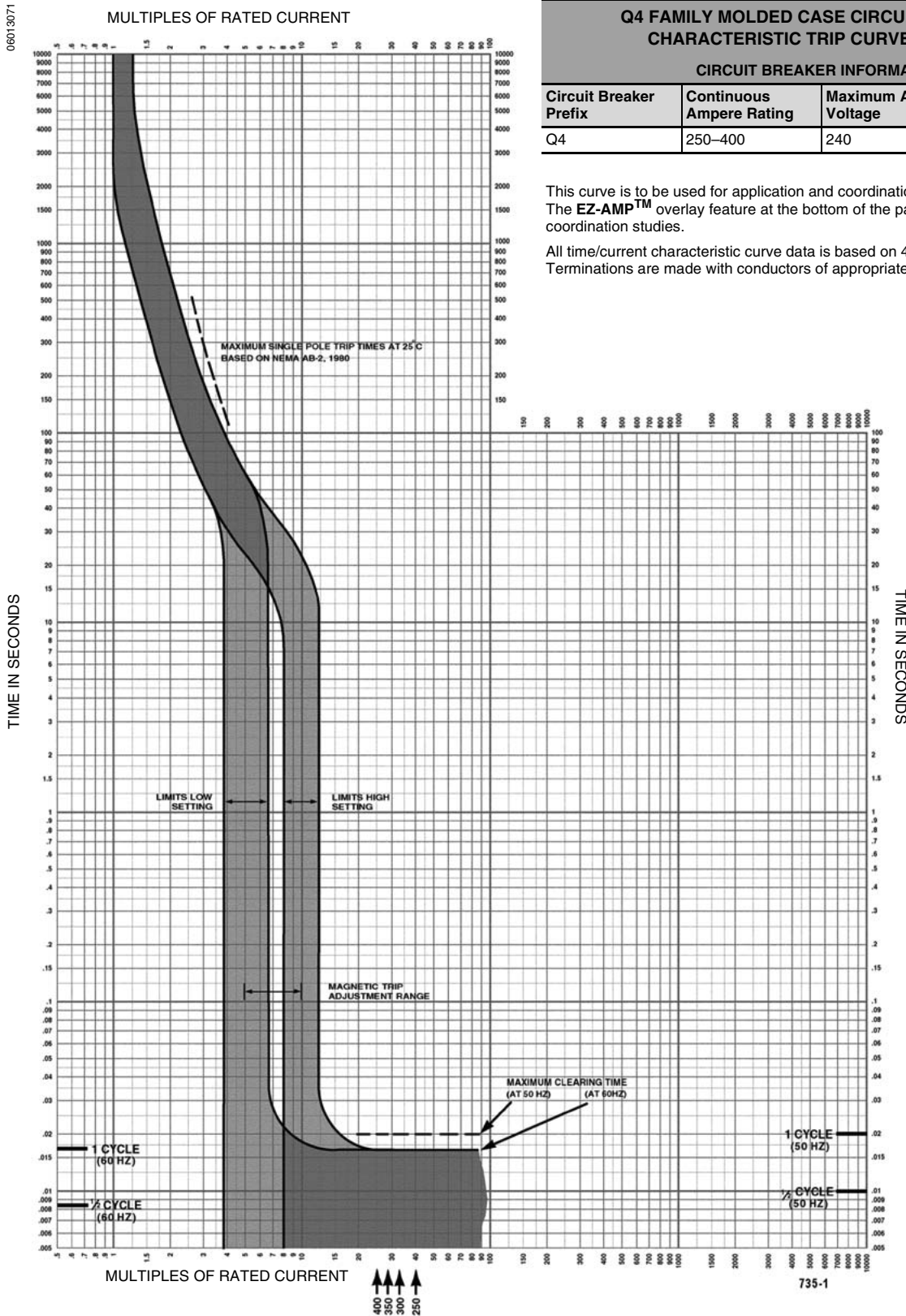

Q4 FAMILY MOLDED CASE CIRCUIT BREAKERS CHARACTERISTIC TRIP CURVE NO. 735-1			
CIRCUIT BREAKER INFORMATION			
Circuit Breaker Prefix	Continuous Ampere Rating	Maximum AC Voltage	Number of Poles
Q4	250-400	240	2, 3

This curve is to be used for application and coordination purposes only. The EZ-AMP™ overlay feature at the bottom of the page should be used during coordination studies.

All time/current characteristic curve data is based on 40°C ambient cold start. Terminations are made with conductors of appropriate length and ratings.

Tripping curves for coordination studies are available upon request.

Curve No. 0735TC8501  
Drawing No. B48095-735-01

# Thermal-Magnetic / Magnetic Only Molded Case Circuit Breakers 400 Ampere Frame

06013072

MULTIPLES OF RATED CURRENT

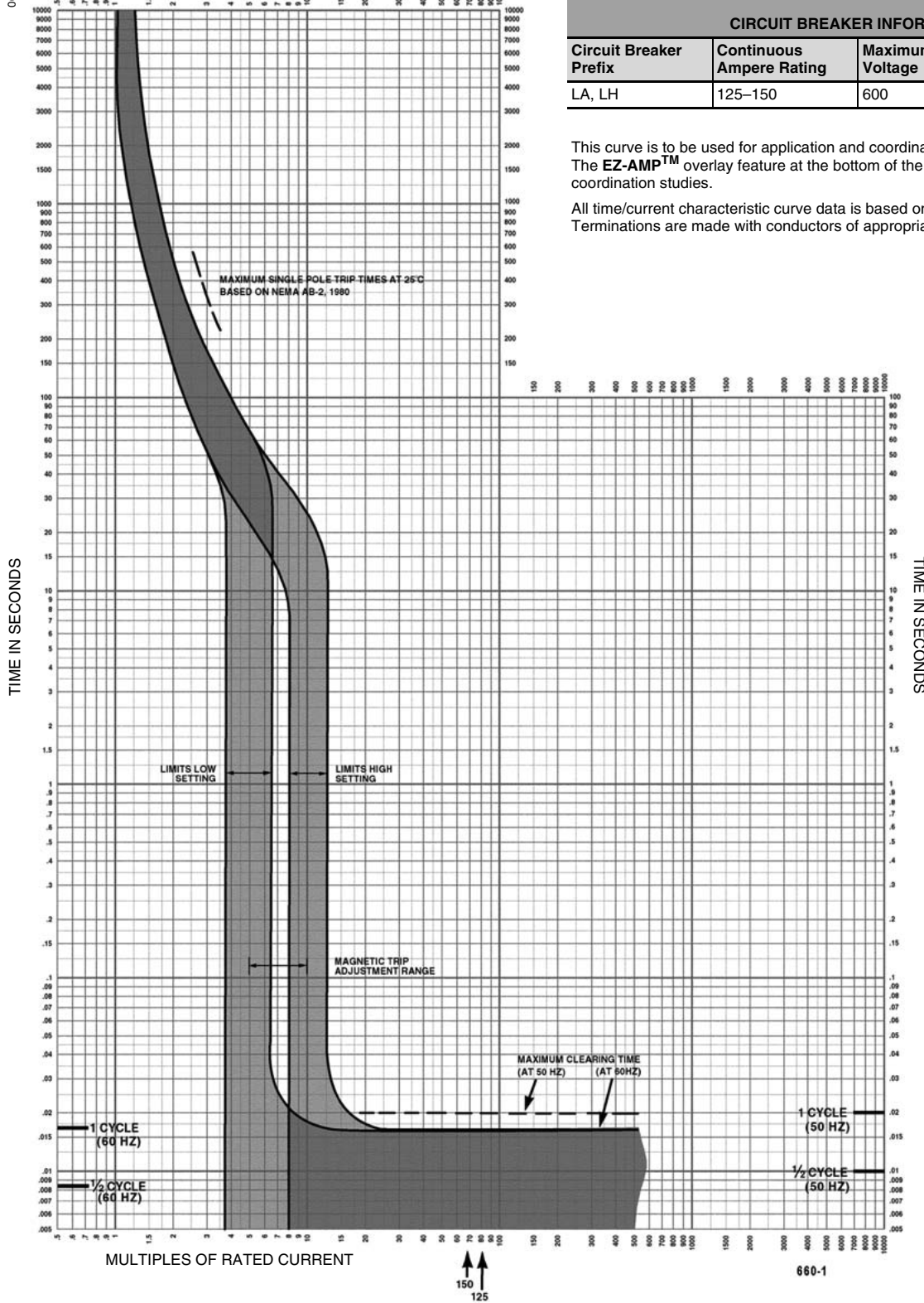

## LA/LH FAMILY MOLDED CASE CIRCUIT BREAKERS CHARACTERISTIC TRIP CURVE NO. 660-1

CIRCUIT BREAKER INFORMATION			
Circuit Breaker Prefix	Continuous Ampere Rating	Maximum AC Voltage	Number of Poles
LA, LH	125-150	600	2, 3

This curve is to be used for application and coordination purposes only. The EZ-AMP™ overlay feature at the bottom of the page should be used during coordination studies.

All time/current characteristic curve data is based on 40°C ambient cold start. Terminations are made with conductors of appropriate length and ratings.

Tripping curves for coordination studies are available upon request.

Curve No. 660-1  
May 1995

# Thermal-Magnetic / Magnetic Only Molded Case Circuit Breakers 400 Ampere Frame

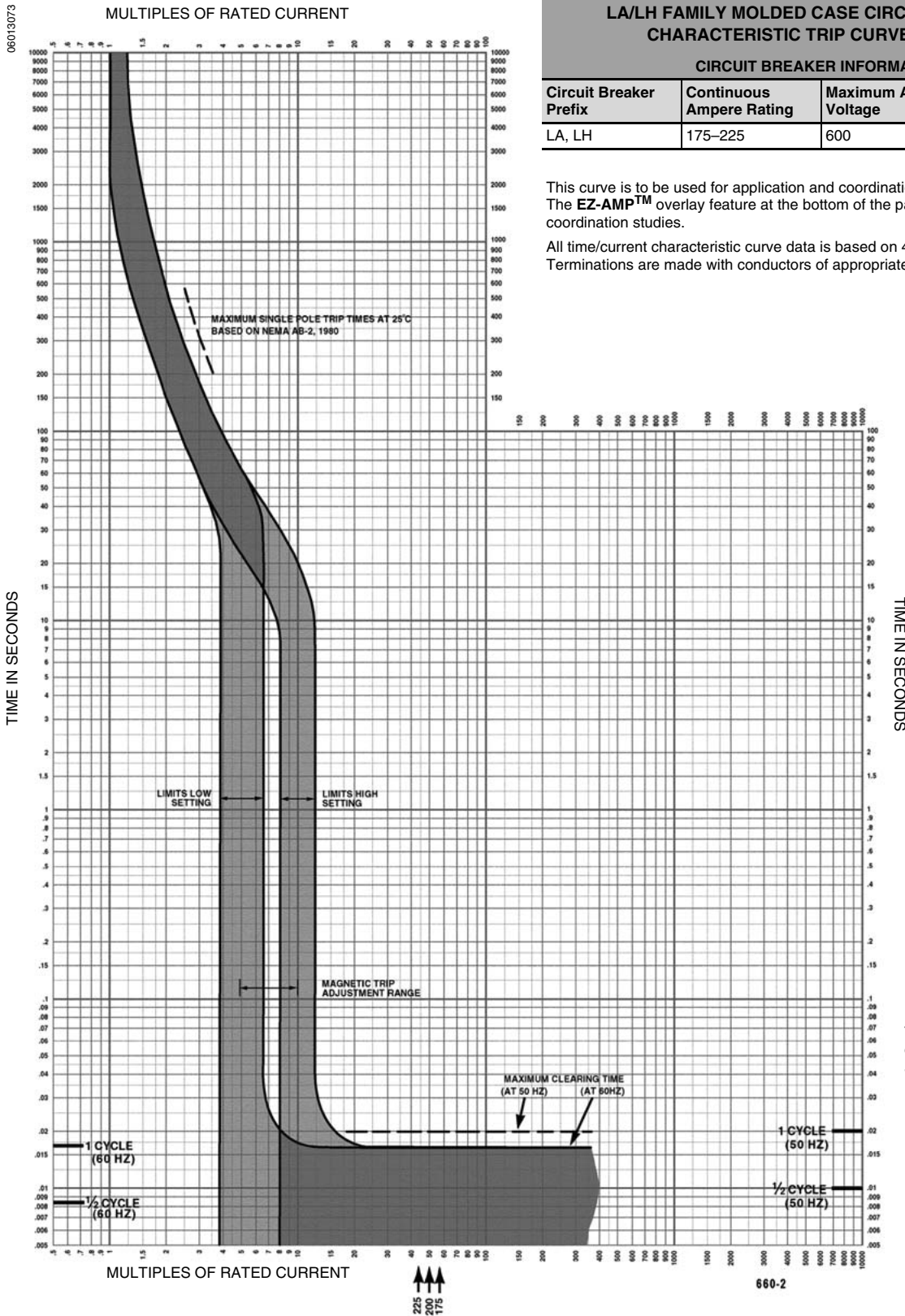

## LA/LH FAMILY MOLDED CASE CIRCUIT BREAKERS CHARACTERISTIC TRIP CURVE NO. 660-2

CIRCUIT BREAKER INFORMATION			
Circuit Breaker Prefix	Continuous Ampere Rating	Maximum AC Voltage	Number of Poles
LA, LH	175-225	600	2, 3

This curve is to be used for application and coordination purposes only. The EZ-AMP™ overlay feature at the bottom of the page should be used during coordination studies.

All time/current characteristic curve data is based on 40°C ambient cold start. Terminations are made with conductors of appropriate length and ratings.

Tripping curves for coordination studies are available upon request.

Curve No. 0660TC8602  
Drawing No. B48095-660-02

# Thermal-Magnetic / Magnetic Only Molded Case Circuit Breakers 400 Ampere Frame

06013074

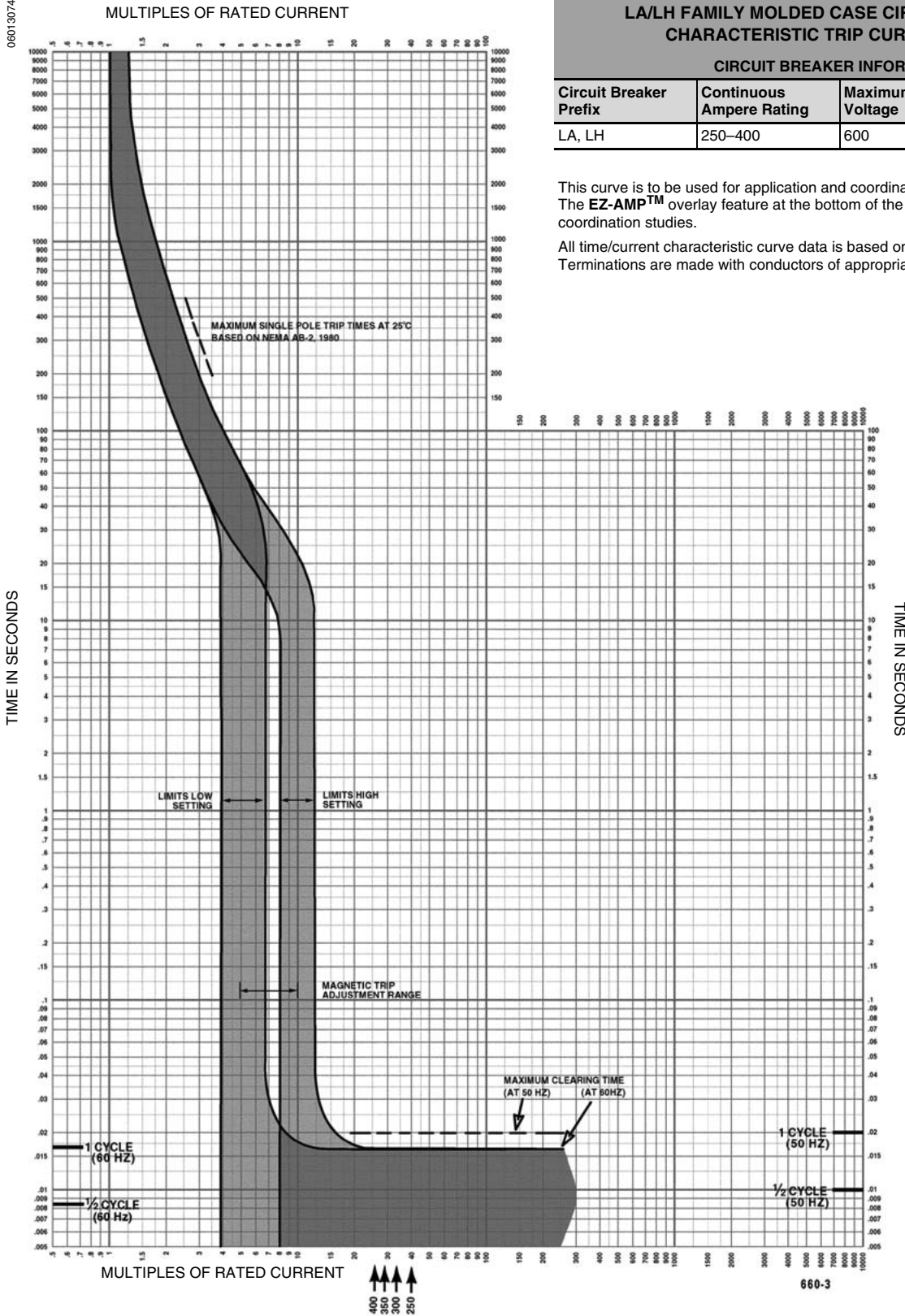

## LA/LH FAMILY MOLDED CASE CIRCUIT BREAKERS CHARACTERISTIC TRIP CURVE NO. 660-3

CIRCUIT BREAKER INFORMATION			
Circuit Breaker Prefix	Continuous Ampere Rating	Maximum AC Voltage	Number of Pole
LA, LH	250-400	600	2, 3

This curve is to be used for application and coordination purposes only. The EZ-AMP™ overlay feature at the bottom of the page should be used during coordination studies.

All time/current characteristic curve data is based on 40°C ambient cold start. Terminations are made with conductors of appropriate length and ratings.

Tripping curves for coordination studies are available upon request.

Curve No. 0660TC8603  
Drawing No. B48095-660-03

# Thermal-Magnetic / Magnetic Only Molded Case Circuit Breakers 600 Ampere Frame

## 600 AMPERE FRAME

This section provides specific information on Square D® 600 ampere frame thermal-magnetic molded case circuit breakers. For more information, see the Introduction in this catalog.

### Description

**Table 28: Description of 600 Ampere Frame Circuit Breakers**

Circuit Breakers	Description
LC/LI	300–600 ampere, 600 Vac, 50/60 Hz, 2- and 3-pole

### Applications

LC and LI circuit breakers are used in industrial enclosures, panelboards, switchboards, busway plug-in units, combination starters and motor control centers.

**Table 29: 600 Ampere Frame Interrupting Ratings**

Catalog Number Prefix		No. of Poles	Cont. Ampere Rating	UL Listed Interrupting Rating (kA)							Federal Specs. W-C-375B/GEN	IEC 60947-2 Icu/Ics (kA) AC Voltage	
Unit Mount	I-Line®			AC Volts - RMS Symmetrical Amperes				DC Volts					
				120	240	480Y/277	480	600	125	250	500		415/240
LCL	LC	2, 3	300–400	—	100	—	65	35	—	—	—	23a	65/65
LCL	LC	2, 3	450–600	—	100	—	65	35	—	—	—	23a	65/50
LIL	LI	2, 3	300–600	—	200	—	200	100	—	—	—	23a	—

### Selection Data

**Table 30: 600 Ampere Frame Unit Mount Circuit Breakers**

Ampere Rating	AC Magnetic Trip Settings Amperes★		Two Pole Catalog No.	Three Pole Catalog No.	Standard Lug Kit Wire Range
<b>LCL Extra High Interrupting</b>					
	Low	High	600 Vac	600 Vac	
300	1500	3200	LCL26300	LCL36300	
350	1750	3200	LCL26350	LCL36350	AL600Li35
400	2000	3200	LCL26400	LCL36400	2-#1-350 kcmil
450	2250	4200	LCL26450	LCL36450	
500	2500	4200	LCL26500	LCL36500	AL600LI5
600	3000	4200	LCL26600	LCL36600	2-4/0-500 kcmil
<b>LIL I-Limiter® Current Limiting</b>					
	Low	High	600 Vac/250 Vdc	600 Vac/250 Vdc	
300	1500	3200	LIL26300	LIL36300	
350	1750	3200	LIL26350	LIL36350	AL600Li35
400	2000	3200	LIL26400	LIL36400	2-#1-350 kcmil
450	2250	4200	LIL26450	LIL36450	
500	2500	4200	LIL26500	LIL36500	AL600LI5
600	3000	4200	LIL26600	LIL36600	2-4/0-500 kcmil

★ UL magnetic trip setting tolerances are -20% /+30% (Low) and -20% /+30% (High) from the nominal values shown.



**LCL/LIL**  
Two- and Three-pole

# Thermal-Magnetic / Magnetic Only Molded Case Circuit Breakers 600 Ampere Frame

**Table 31: 600 Ampere I-Line® Mount Circuit Breakers**

Ampere Rating	AC Magnetic Trip Settings Amperes <sup>▲</sup>		Two Pole <sup>★</sup> Catalog No.	Three Pole Catalog No.	Standard Lug Kit Wire Range
<b>LC Extra High Interrupting</b>					
	Low	High	600 Vac	600 Vac	
300	1500	3200	LC26300( )	LC36300	AL600Li35 2-#1-350 kcmil
350	1750	3200	LC26350( )	LC36350	
400	2000	3200	LC26400( )	LC36400	
450	2250	4200	LC26450( )	LC36450	AL600Li5 2-4/0-500 kcmil
500	2500	4200	LC26500( )	LC36500	
600	3000	4200	LC26600( )	LC36600	
<b>LI I-Limiter® Current Limiting</b>					
	Low	High	600 Vac/250 Vdc	600 Vac/250 Vdc	
300	1500	3200	li26300( )	li36300	AL600Li35 2-#1-350 kcmil
350	1750	3200	li26350( )	li36350	
400	2000	3200	li26400( )	li36400	
450	2250	4200	LI26450( )	LI36450	AL600Li5 2-4/0-500 kcmil
500	2500	4200	LI26500( )	LI36500	
600	3000	4200	LI26600( )	LI36600	

★ Two pole circuit breaker catalog numbers are completed by adding required phase connection letters as a suffix to the catalog number.

▲ UL magnetic trip setting tolerances are -20% /+30% (Low) and -20% /+30% (High) from the nominal values shown.

## Dimensions

**Figure 15: LCL, LIL 600 Ampere Frame**

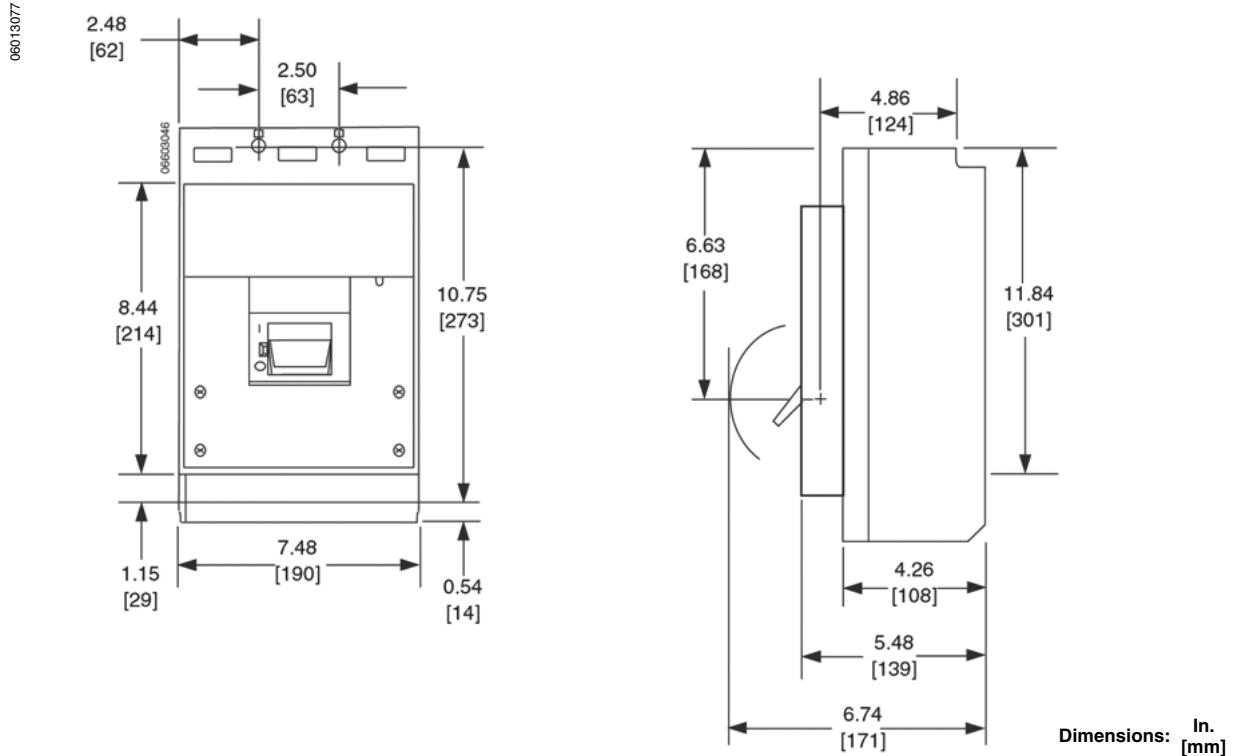

# Thermal-Magnetic / Magnetic Only Molded Case Circuit Breakers 600 Ampere Frame

## Tripping Curves

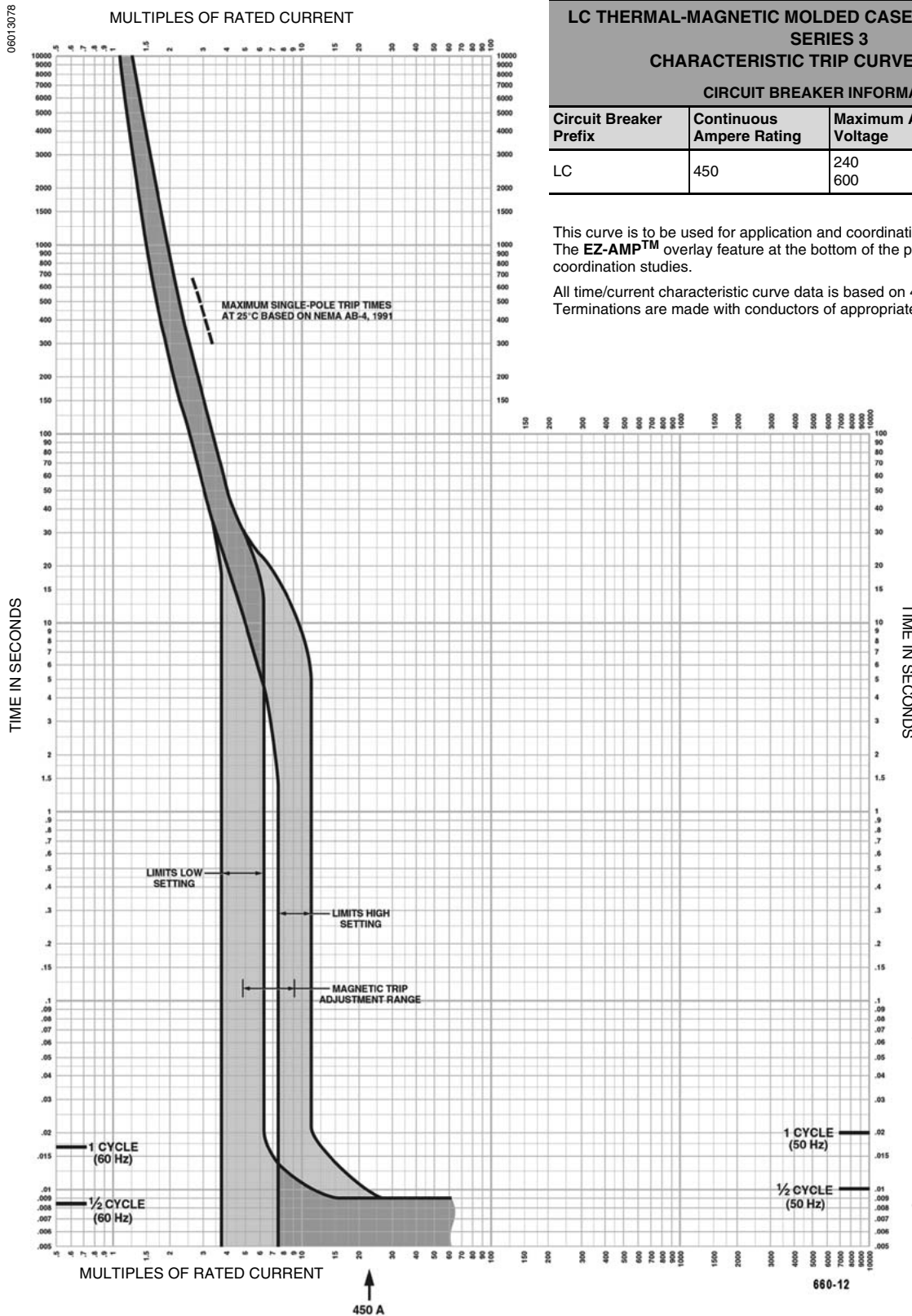

LC THERMAL-MAGNETIC MOLDED CASE CIRCUIT BREAKERS SERIES 3 CHARACTERISTIC TRIP CURVE NO. 660-12			
CIRCUIT BREAKER INFORMATION			
Circuit Breaker Prefix	Continuous Ampere Rating	Maximum AC Voltage	Number of Poles
LC	450	240 600	2, 3

This curve is to be used for application and coordination purposes only. The **EZ-AMP™** overlay feature at the bottom of the page should be used during coordination studies.

All time/current characteristic curve data is based on 40°C ambient cold start. Terminations are made with conductors of appropriate length and ratings.

Tripping curves for coordination studies are available upon request.

Curve No. 0660TC0212  
March 2002  
Drawing No. B48095-660-12

# Thermal-Magnetic / Magnetic Only Molded Case Circuit Breakers 600 Ampere Frame

06013079

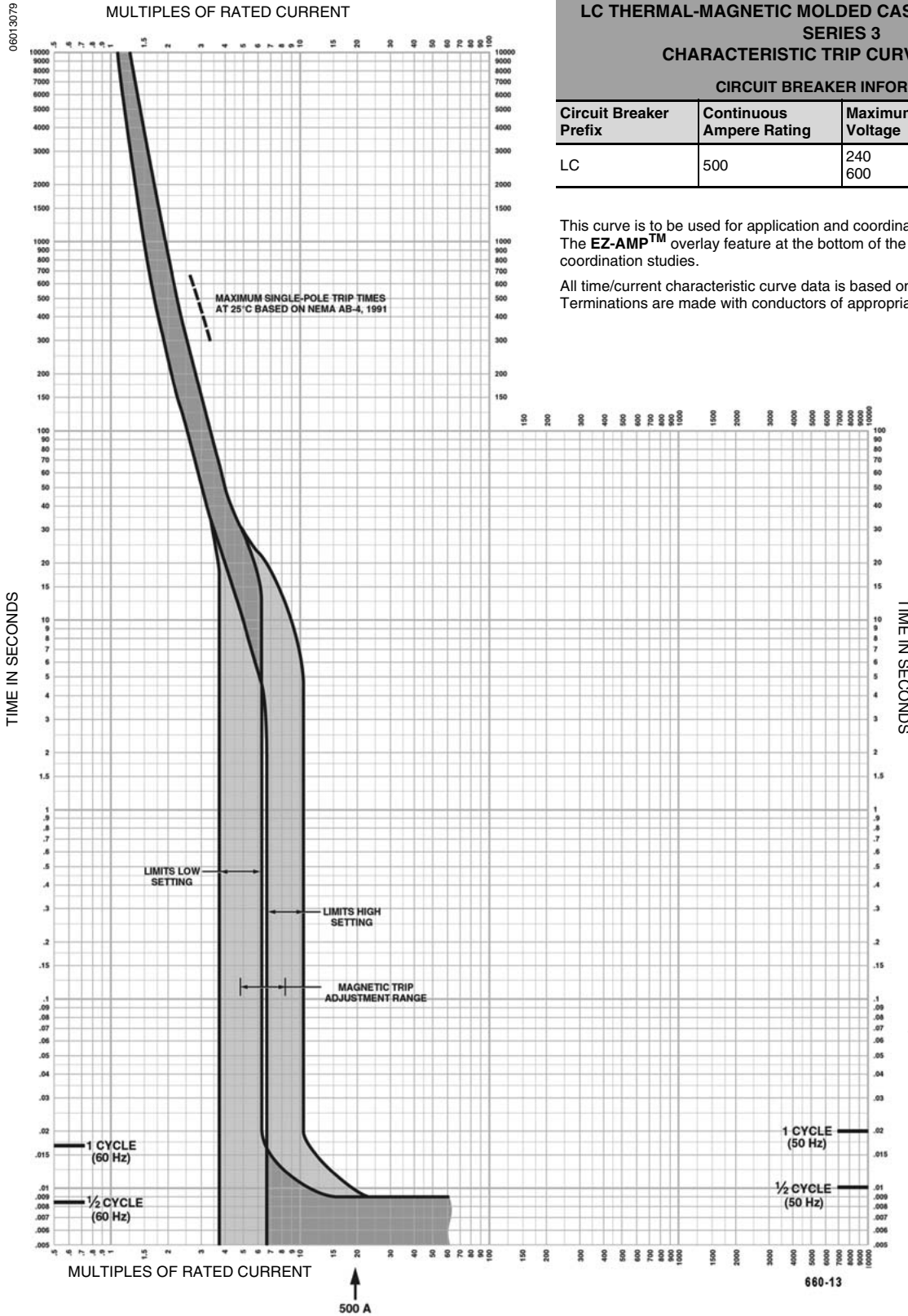

LC THERMAL-MAGNETIC MOLDED CASE CIRCUIT BREAKERS SERIES 3 CHARACTERISTIC TRIP CURVE NO. 660-13			
CIRCUIT BREAKER INFORMATION			
Circuit Breaker Prefix	Continuous Ampere Rating	Maximum AC Voltage	Number of Poles
LC	500	240 600	2, 3

This curve is to be used for application and coordination purposes only. The **EZ-AMP™** overlay feature at the bottom of the page should be used during coordination studies.

All time/current characteristic curve data is based on 40°C ambient cold start. Terminations are made with conductors of appropriate length and ratings.

Tripping curves for coordination studies are available upon request.

Curve No. 0660TC0213  
March 2002  
Drawing No. B48095-660-13

# Thermal-Magnetic / Magnetic Only Molded Case Circuit Breakers 600 Ampere Frame

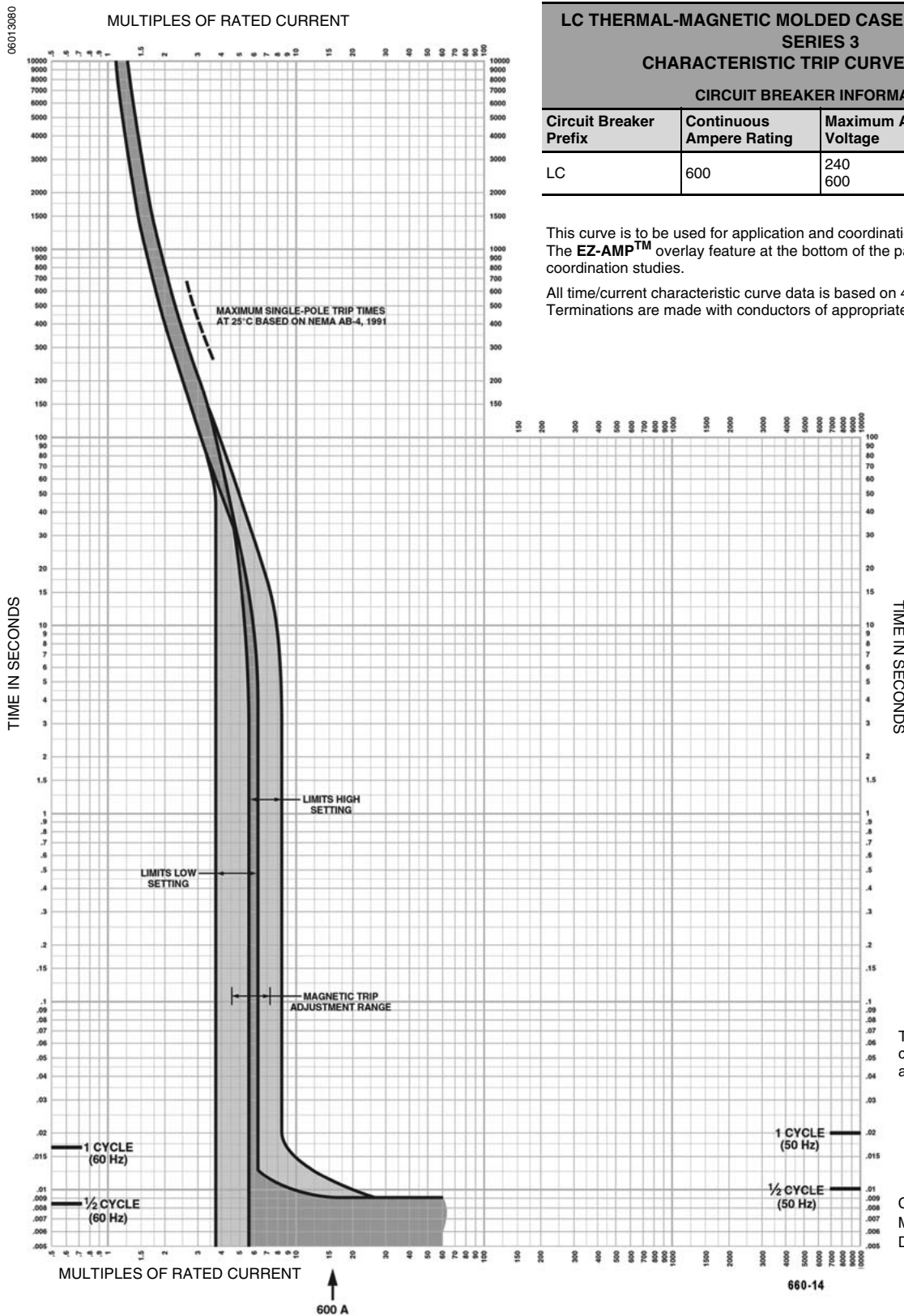

LC THERMAL-MAGNETIC MOLDED CASE CIRCUIT BREAKERS SERIES 3 CHARACTERISTIC TRIP CURVE NO. 660-14			
CIRCUIT BREAKER INFORMATION			
Circuit Breaker Prefix	Continuous Ampere Rating	Maximum AC Voltage	Number of Poles
LC	600	240 600	2, 3

This curve is to be used for application and coordination purposes only. The EZ-AMP™ overlay feature at the bottom of the page should be used during coordination studies.

All time/current characteristic curve data is based on 40°C ambient cold start. Terminations are made with conductors of appropriate length and ratings.

Tripping curves for coordination studies are available upon request.

Curve No. 0660TC0214  
March 2002  
Drawing No. B48095-660-14

# Thermal-Magnetic / Magnetic Only Molded Case Circuit Breakers 600 Ampere Frame

06013081

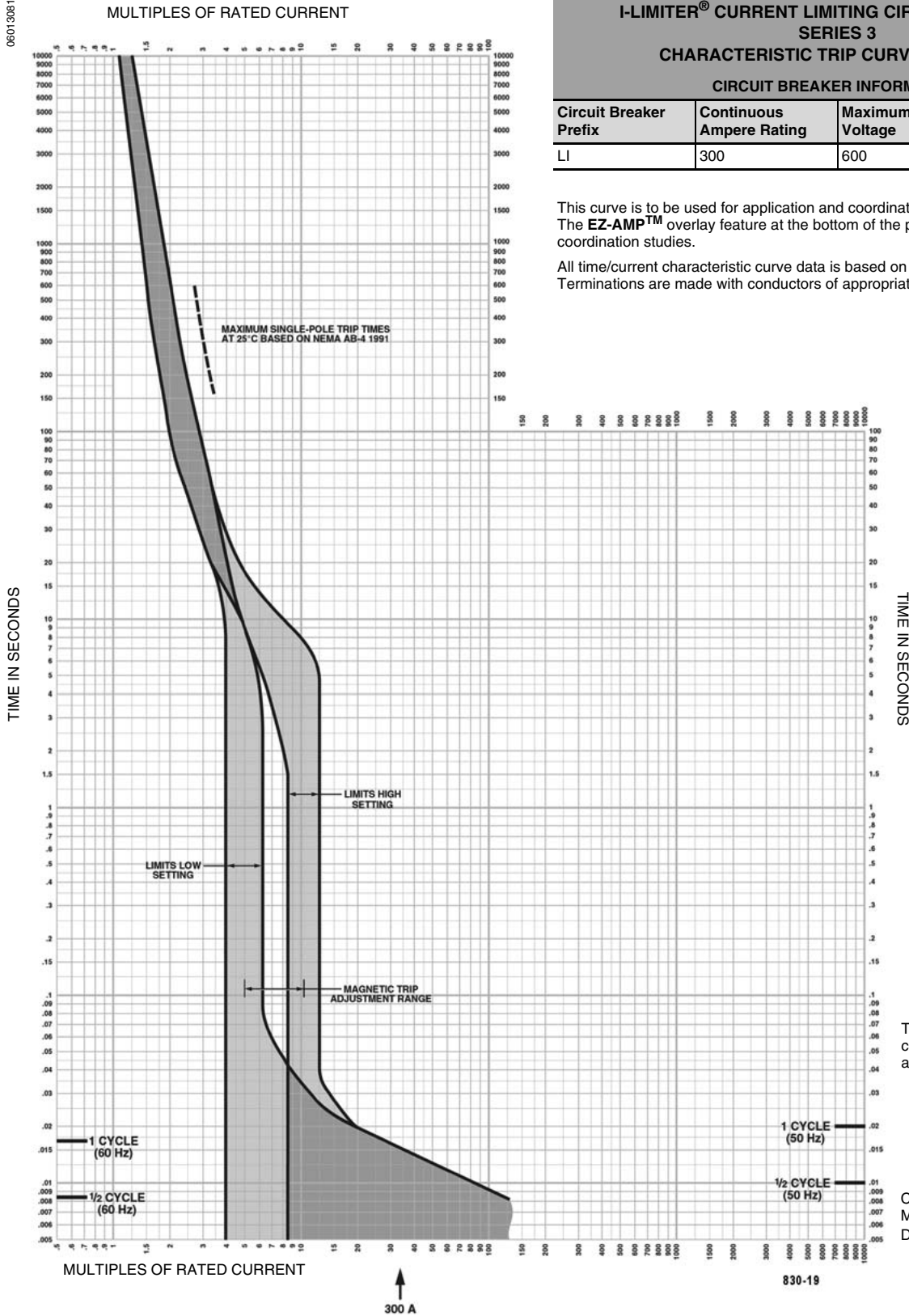

## I-LIMITER® CURRENT LIMITING CIRCUIT BREAKERS SERIES 3 CHARACTERISTIC TRIP CURVE NO. 830-19

CIRCUIT BREAKER INFORMATION			
Circuit Breaker Prefix	Continuous Ampere Rating	Maximum AC Voltage	Number of Pole
LI	300	600	2, 3

This curve is to be used for application and coordination purposes only. The **EZ-AMP™** overlay feature at the bottom of the page should be used during coordination studies.

All time/current characteristic curve data is based on 40°C ambient cold start. Terminations are made with conductors of appropriate length and ratings.

Tripping curves for coordination studies are available upon request.

Curve No. 0830TC0219  
March 2002  
Drawing No. B48095-830-19

# Thermal-Magnetic / Magnetic Only Molded Case Circuit Breakers 600 Ampere Frame

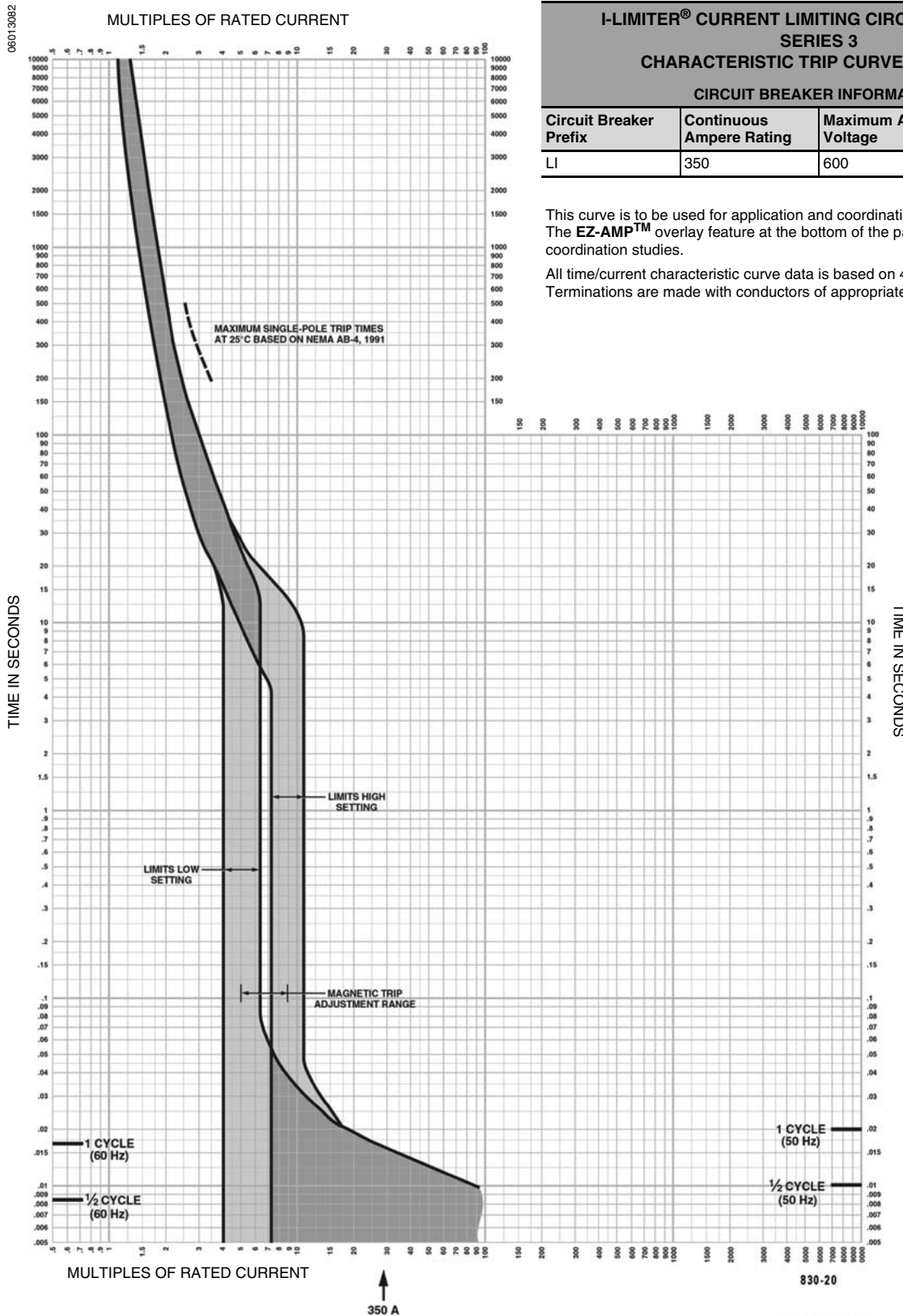

I-LIMITER® CURRENT LIMITING CIRCUIT BREAKERS SERIES 3 CHARACTERISTIC TRIP CURVE NO. 830-20			
CIRCUIT BREAKER INFORMATION			
Circuit Breaker Prefix	Continuous Ampere Rating	Maximum AC Voltage	Number of Poles
LI	350	600	2, 3

This curve is to be used for application and coordination purposes only. The **EZ-AMP™** overlay feature at the bottom of the page should be used during coordination studies.

All time/current characteristic curve data is based on 40°C ambient cold start. Terminations are made with conductors of appropriate length and ratings.

Tripping curves for coordination studies are available upon request.

Curve No. 0830TC0220  
March 2002  
Drawing No. B48095-830-20

# Thermal-Magnetic / Magnetic Only Molded Case Circuit Breakers 600 Ampere Frame

06013083

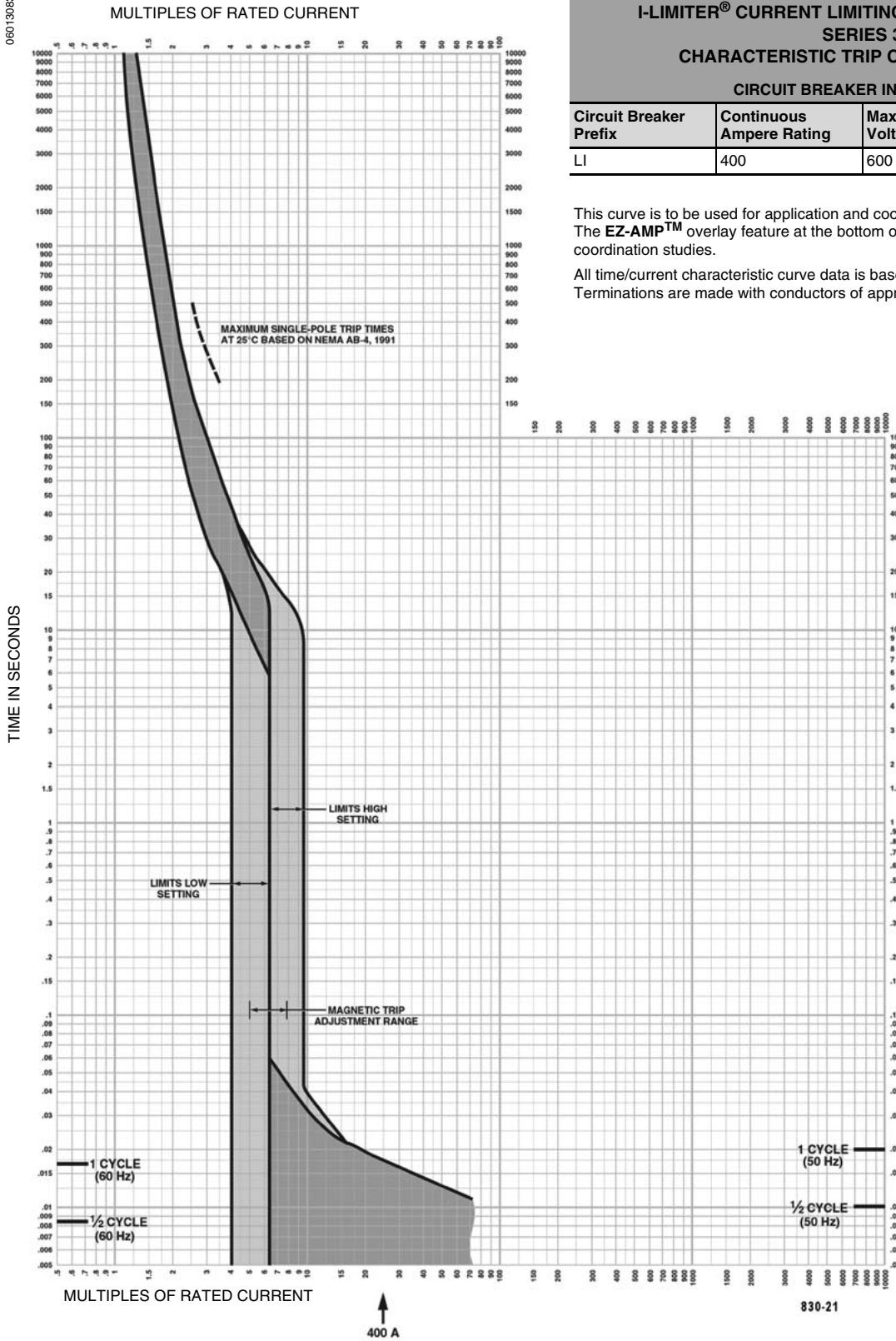

<b>I-LIMITER® CURRENT LIMITING CIRCUIT BREAKERS SERIES 3 CHARACTERISTIC TRIP CURVE NO. 830-21</b>			
<b>CIRCUIT BREAKER INFORMATION</b>			
Circuit Breaker Prefix	Continuous Ampere Rating	Maximum AC Voltage	Number of Pole
LI	400	600	2, 3

This curve is to be used for application and coordination purposes only. The **EZ-AMP™** overlay feature at the bottom of the page should be used during coordination studies.

All time/current characteristic curve data is based on 40°C ambient cold start. Terminations are made with conductors of appropriate length and ratings.

Tripping curves for coordination studies are available upon request.

Curve No. 0830TC0221  
March 2002  
Drawing No. B48095-830-21

# Thermal-Magnetic / Magnetic Only Molded Case Circuit Breakers 600 Ampere Frame

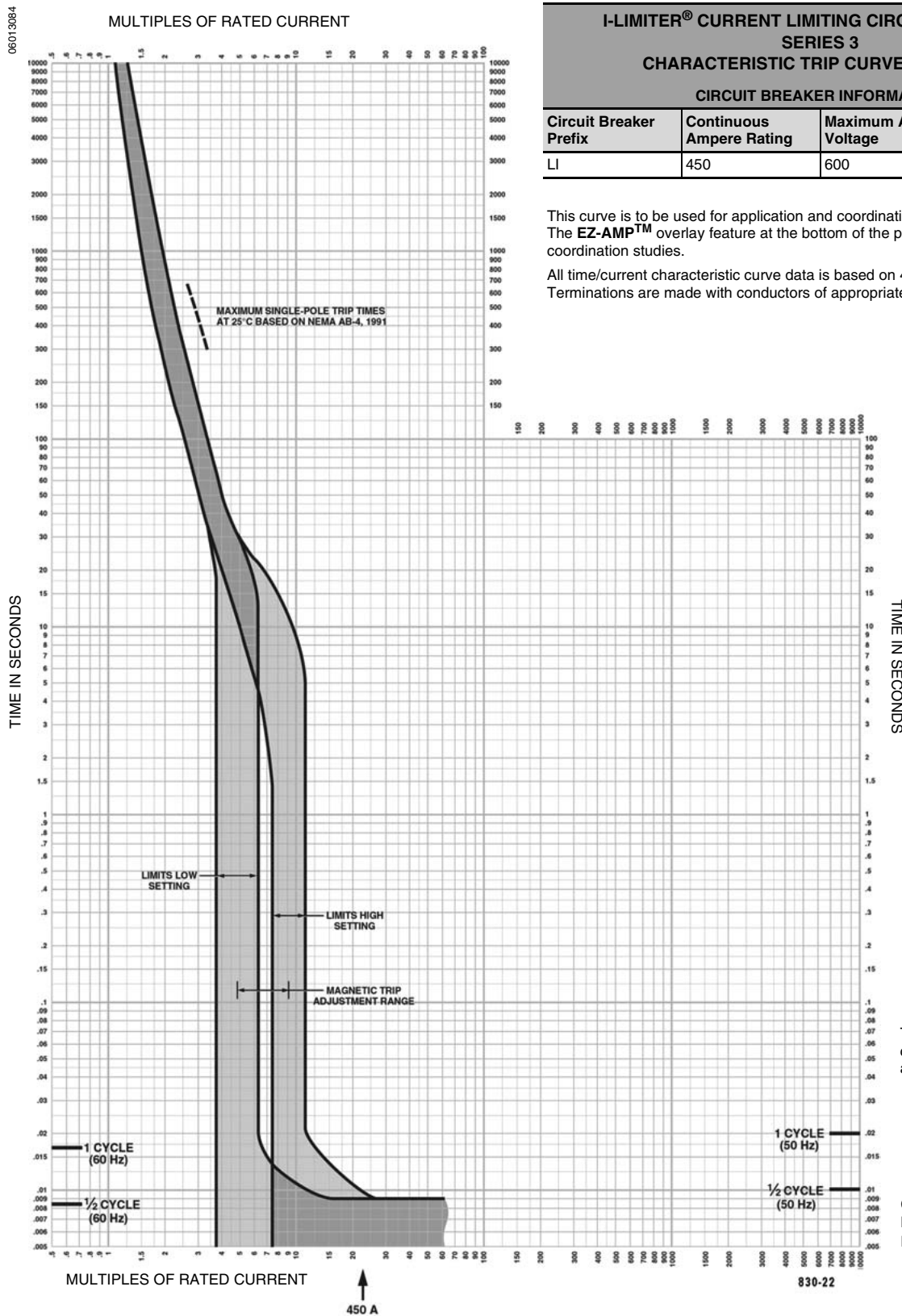

I-LIMITER® CURRENT LIMITING CIRCUIT BREAKERS SERIES 3 CHARACTERISTIC TRIP CURVE NO. 830-22			
CIRCUIT BREAKER INFORMATION			
Circuit Breaker Prefix	Continuous Ampere Rating	Maximum AC Voltage	Number of Poles
LI	450	600	2, 3

This curve is to be used for application and coordination purposes only. The **EZ-AMP™** overlay feature at the bottom of the page should be used during coordination studies. All time/current characteristic curve data is based on 40°C ambient cold start. Terminations are made with conductors of appropriate length and ratings.

Tripping curves for coordination studies are available upon request.

Curve No. 0830TC0222  
March 2002  
Drawing No. B48095-830-22

# Thermal-Magnetic / Magnetic Only Molded Case Circuit Breakers 600 Ampere Frame

06013085

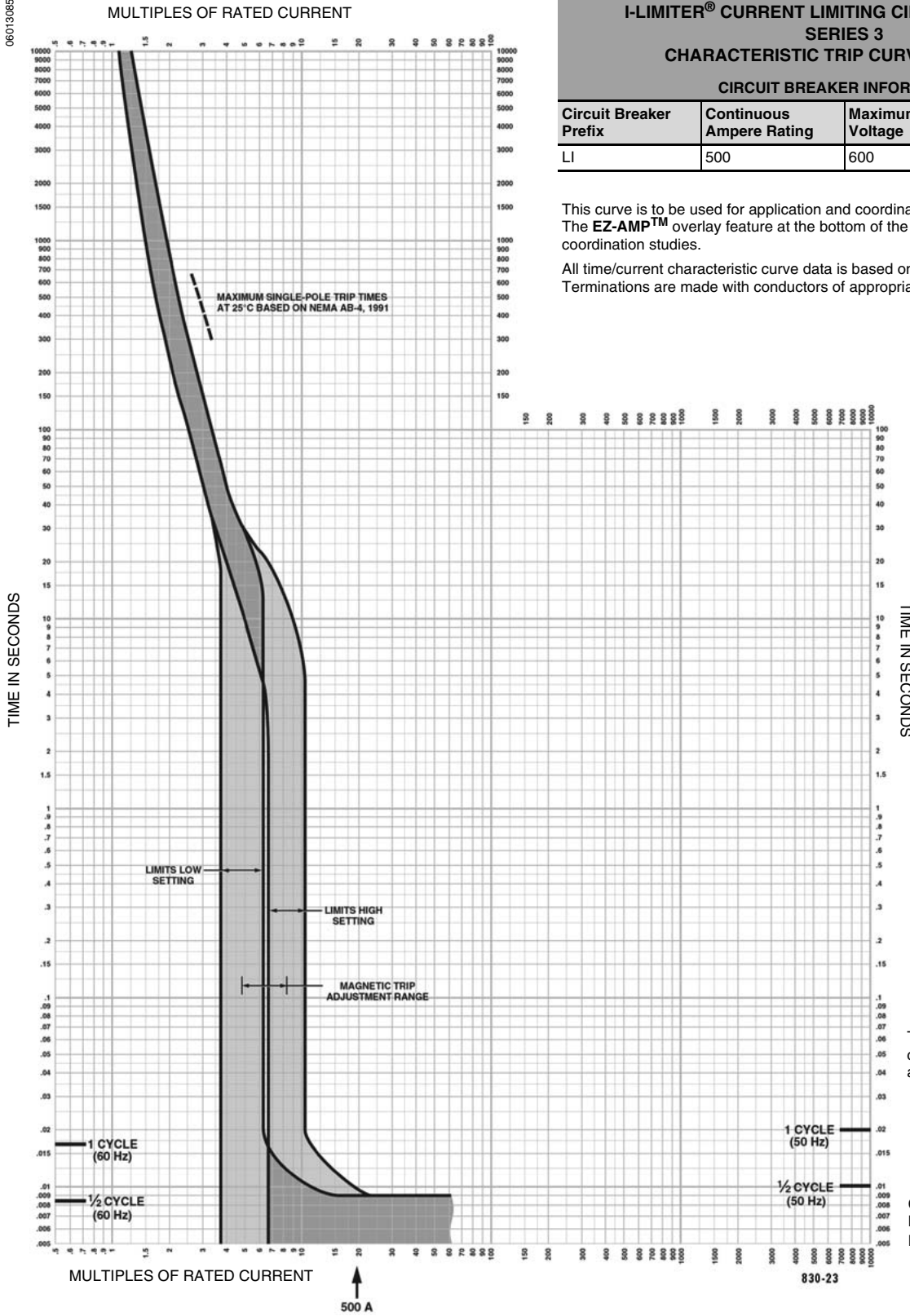

<b>I-LIMITER® CURRENT LIMITING CIRCUIT BREAKERS SERIES 3 CHARACTERISTIC TRIP CURVE NO. 830-23</b>			
<b>CIRCUIT BREAKER INFORMATION</b>			
Circuit Breaker Prefix	Continuous Ampere Rating	Maximum AC Voltage	Number of Pole
LI	500	600	2, 3

This curve is to be used for application and coordination purposes only. The **EZ-AMP™** overlay feature at the bottom of the page should be used during coordination studies.

All time/current characteristic curve data is based on 40°C ambient cold start. Terminations are made with conductors of appropriate length and ratings.

Tripping curves for coordination studies are available upon request.

Curve No. 0830TC0223  
March 2002  
Drawing No. B48095-830-23

# Thermal-Magnetic / Magnetic Only Molded Case Circuit Breakers 600 Ampere Frame

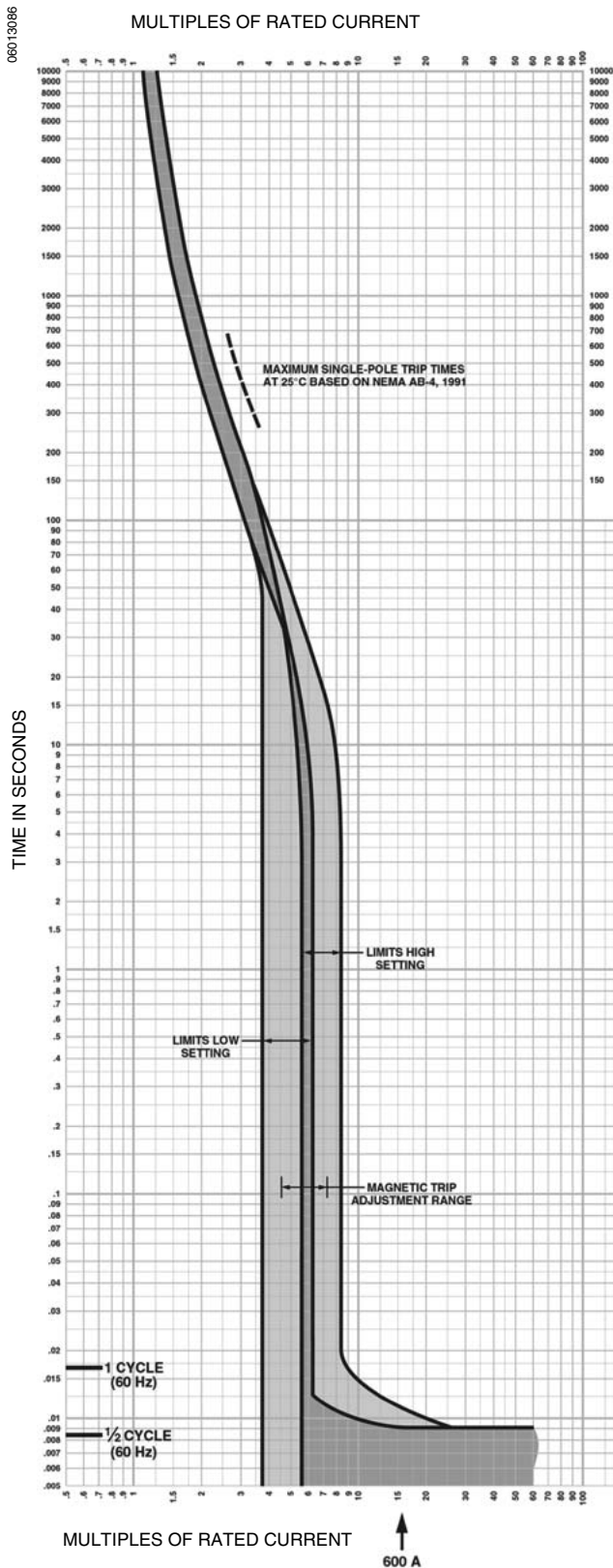

I-LIMITER® CURRENT LIMITING CIRCUIT BREAKERS SERIES 3 CHARACTERISTIC TRIP CURVE NO. 830-24			
CIRCUIT BREAKER INFORMATION			
Circuit Breaker Prefix	Continuous Ampere Rating	Maximum AC Voltage	Number of Poles
LI	600	600	2, 3

This curve is to be used for application and coordination purposes only. The EZ-AMP™ overlay feature at the bottom of the page should be used during coordination studies. All time/current characteristic curve data is based on 40°C ambient cold start. Terminations are made with conductors of appropriate length and ratings.

Tripping curves for coordination studies are available upon request.  
Curve No. 0830TC0224  
March 2002  
Drawing No. B48095-830-24

# Thermal-Magnetic / Magnetic Only Molded Case Circuit Breakers 600 Ampere Frame

## Let-through Curves

**I-LIMITER® CURRENT LIMITING CIRCUIT BREAKERS**  
**LI Series 2, 3 and LXI Series 2B, 3B 400 Ampere Frame at 240, 480 and 600 Vac, 3Ø**  
**300–400 Amperes**  
**LXI Series 2B, 3B 250 Ampere Frame at 240, 480, and 600 Vac, 3Ø**  
**100–250 Ampere**  
**Curve No. 830-15 Let-Through  $I^2t$  and 830-16 Peak Let-Through Current  $I_p$**

06013087

**Typical★ Let-Through  $I^2t$  (Amperes<sup>2</sup> Seconds x  $10^6$ )**

★Based on typical values obtained throughout the circuit breaker development and UL test programs.

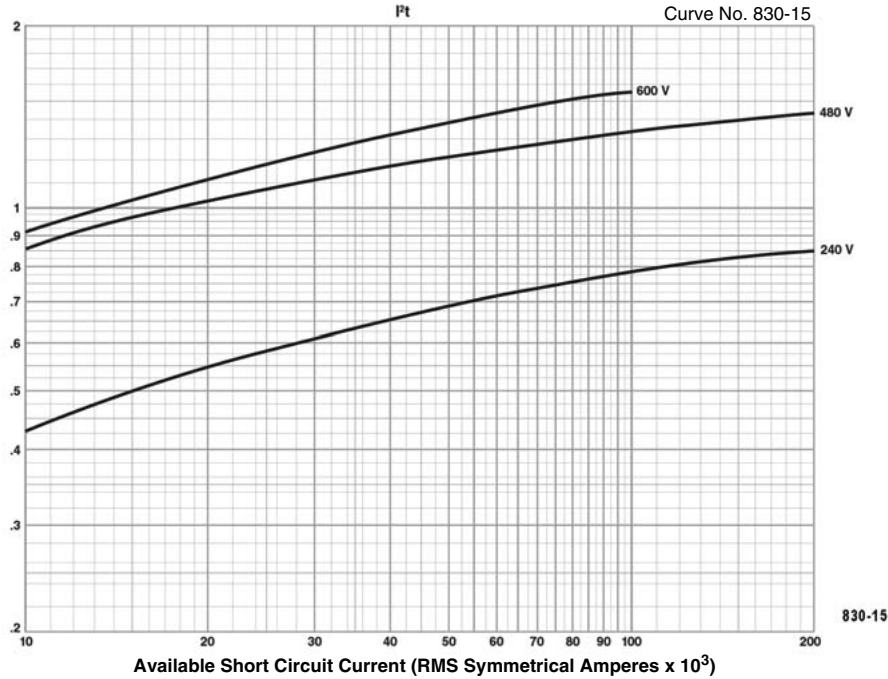

06013088

**Maximum★ Let-Through  $I^2t$  (Amperes<sup>2</sup> Seconds x  $10^3$ )**

★Based on maximum values obtained throughout the circuit breaker development and UL test programs.

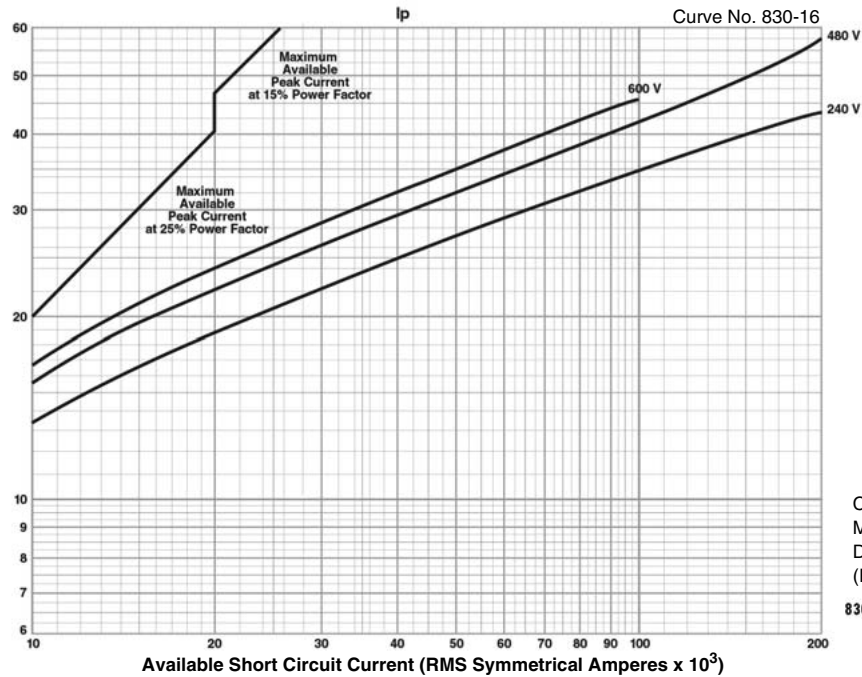

Curve No. 0830TC0216  
 March 2002  
 Drawing No. B48095-830-16  
 (Replaces No. 0830TC9616)

830-16

# Thermal-Magnetic / Magnetic Only Molded Case Circuit Breakers 600 Ampere Frame

## I-LIMITER® CURRENT LIMITING CIRCUIT BREAKERS LI Series 2, 3 and LXI Series 2B, 3B 600 Ampere Frame at 240, 480 and 600 Vac, 3Ø 450–600 Amperes Curve No. 830-17 Let-Through $I^2t$ and 830-18 Peak Let-Through Current $I_p$

06013089

Typical\* Let-Through  $I^2t$  (Amperes<sup>2</sup> Seconds x 10<sup>6</sup>)

\*Based on typical values obtained throughout the circuit breaker development and UL test programs.

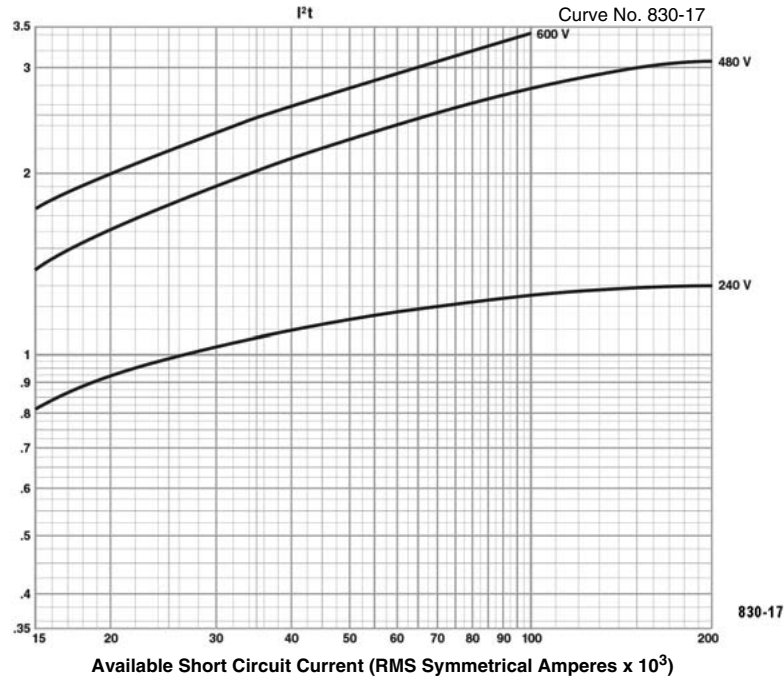

06013090

Maximum\* Let-Through  $I^2t$  (Amperes Seconds x 10<sup>3</sup>)

\*Based on maximum values obtained throughout the circuit breaker development and UL test programs.

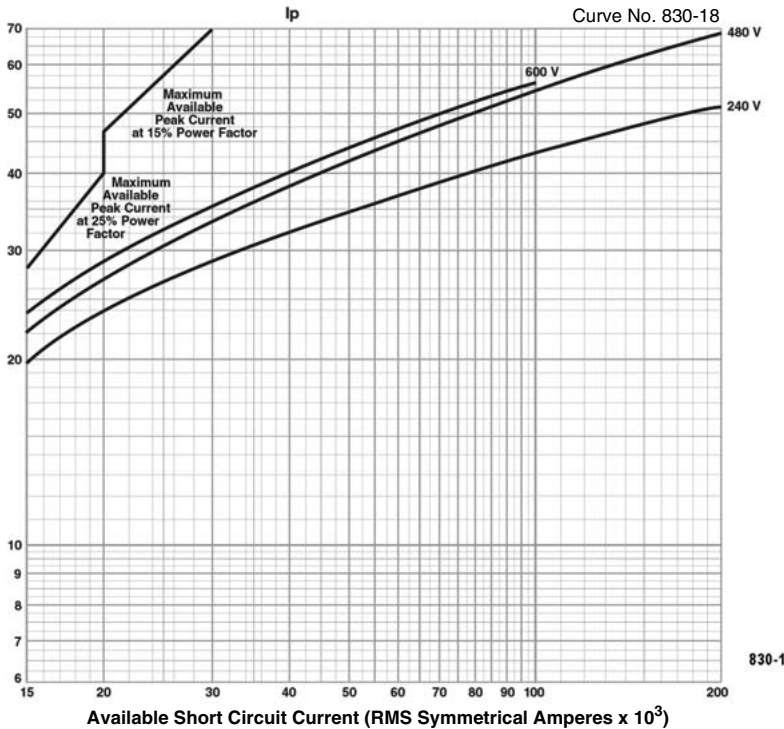

Curve No. 0830TC0218  
March 2002  
Drawing No. B48095-830-18  
(Replaces No. 0830TC9618)

830-18

# Thermal-Magnetic / Magnetic Only Molded Case Circuit Breakers 800 / 1000 Ampere Frame

## 800 / 1000 AMPERE FRAME

This section provides specific information on Square D® 800 / 1000 ampere frame thermal-magnetic molded case circuit breakers. For more information, see the Introduction in this catalog.

### Description

**Table 32: Description of 800 / 1000 Ampere Frame Circuit Breakers**

Circuit Breaker	Description
MG/MJ	300-800 ampere, 600 Vac, 50/60 Hz, 2- and 3-pole
MA/MH	300-800 ampere, 600 Vac, 50/60 Hz, 250 Vdc, 2- and 3-pole
MAL/MHL	300-1200 ampere, 600 Vac, 50/60 Hz, 250 Vdc, 2- and 3-pole

### Applications

MA / MH circuit breakers are used in industrial enclosures, panelboards, switchboards, busway plug-in units, combination starters and motor control centers.

**Table 33: 800 / 1000 Ampere Frame Interrupting Ratings**

Catalog Number Prefix		No. of Poles	Cont. Ampere Rating	UL Listed Interrupting Rating (kA)							Federal Specs. W-C-375B/GEN	IEC 60947-2 Icu/Ics (kA) AC Voltage	
Unit Mount	I-Line®			AC Volts - RMS Symmetrical Amperes				DC Volts					
				120	240	480Y/277	480	600	125	250	500		415/240
MAL	—	2, 3	300-1000	42	42	30	30	22	14	14	—	21a	30/30
—	MA	2, 3	300-800	42	42	30	30	22	14	14	—	21a	30/30
MHL★	—	2, 3	300-1000	65	65	65	65	25	—	—	—	23a	65/33
—	MH★	2, 3	300-800	65	65	65	65	25	14	14	—	23a	65/33
LHL-DC▲	—	3	—	—	—	—	—	—	—	—	20	—	—

★ Separate UL rating available for 240 Vac and 480 Vac grounded B single phase systems. Breakers must be ordered with 5861 suffix. See *Supplemental Digest* for specific ratings.

▲ UL Listed 500 Vdc rating for use on ungrounded systems. Must be connected 3 poles in series. Consult your local Square D sales office for additional information 1-888-Square D.

**Table 34: 800 Ampere Powerpact® M-frame Molded Case Circuit Breakers★**

Catalog Number Prefix		No. of Poles	Cont. Ampere Rating	UL Listed Interrupting Rating (kA)							Federal Specs. W-C-375B/GEN	IEC 60947-2 Icu/Ics (kA) AC Voltage	
Unit Mount	I-Line			AC Volts - RMS Symmetrical Amperes				DC Volts					
				120	240	480Y/277	480	600	125	250	500		415/240
MG	▲	2, 3	300-800	65	65	35	35	18	—	—	—	22a	35/17.5
MJ	▲	2, 3	300-800	100	100	65	65	25	—	—	—	23a	50/25

★ See Powerpact Class 611, 612, 613, and 734 catalogs for other Powerpact and Masterpact® circuit breakers.

▲ See the Introduction section, Powerpact M-frame Catalog Numbering System, for available information.

# Thermal-Magnetic / Magnetic Only Molded Case Circuit Breakers 800 / 1000 Ampere Frame

## Selection Data

**Table 35: 800 Ampere I-Line® Circuit Breakers**

Ampere Rating	AC Magnetic Trip Settings Amperes <sup>▲</sup>		Two Pole <sup>★</sup> Catalog No.	Three Pole Catalog No.	Standard Lug Kit Wire Range
<b>MA Standard Interrupting</b>					
	Low	High	600 Vac/250 Vdc	600 Vac/250 Vdc	
300	1500	3000	MA26300( )	MA36300	AL900MA 3-#3/0-500 kcmil
350	1750	3500	MA26350( )	MA36350	
400	2000	4000	MA26400( )	MA36400	
450	2250	4500	MA26450( )	MA36450	
500	2500	5000	MA26500( )	MA36500	
600	3000	6000	MA26600( )	MA36600	
700	3500	7000	MA26700( )	MA36700	
800	4000	8000	MA26800( )	MA36800	
<b>MH High Interrupting</b>					
	Low	High	600 Vac/250 Vdc	600 Vac/250 Vdc	
300	1500	3000	MH26300( )	MH36300	AL900MA 3-#3/0-500 kcmil
350	1750	3500	MH26350( )	MH36350	
400	2000	4000	MH26400( )	MH36400	
450	2250	4500	MH26450( )	MH36450	
500	2500	5000	MH26500( )	MH36500	
600	3000	6000	MH26600( )	MH36600	
700	3500	7000	MH26700( )	MH36700	
800	4000	8000	MH26800( )	MH36800	

★ Two pole circuit breaker catalog numbers are completed by adding required phase connection letters as a suffix to the catalog number.

▲ UL magnetic trip setting tolerances are -20% /+30% (Low) and -20% /+30% (High) from the nominal values shown.

**Table 36: 1000 Ampere Frame Unit Mount Circuit Breakers**

Ampere Rating	AC Magnetic Trip Settings Amperes <sup>▲</sup>		Two Pole <sup>★</sup> Catalog No.	Three Pole Catalog No.	Standard Lug Kit Wire Range
<b>MAL Standard Interrupting</b>					
	Low	High	600 Vac/250 Vdc	600 Vac/250 Vdc	
300	1500	3000	MAL26300	MAL36300	AL900MA 3-#3/0-350 kcmil
350	1750	3500	MAL26350	MAL36350	
400	2000	4000	MAL26400	MAL36400	
450	2250	4500	MAL26450	MAL36450	
500	2500	5000	MAL26500	MAL36500	
600	3000	6000	MAL26600	MAL36600	
700	3500	7000	MAL26700	MAL36700	
800	4000	8000	MAL26800	MAL36800	
900	4500	9000	MAL26900	MAL36900	
1000	5000	10000	MAL261000	MAL361000	
1200	5100	10200	MHL261200	MHL361200	AL1000MA 4-#1/0-500 kcmil

*Continued on next page*



**MA/MH**  
Two- and Three-pole  
9" Mounting Height  
300-800 Amperes



**MAL/MHL**  
Two- and Three-pole  
300-1000 Amperes

## Thermal-Magnetic / Magnetic Only Molded Case Circuit Breakers 800 / 1000 Ampere Frame

**Table 36: 1000 Ampere Frame Unit Mount Circuit Breakers** *(continued)*

Ampere Rating	AC Magnetic Trip Settings Amperes <sup>▲</sup>		Two Pole <sup>★</sup> Catalog No.	Three Pole Catalog No.	Standard Lug Kit Wire Range
<b>MHL High Interrupting</b>					
	Low	High	600 Vac/250 Vdc	600 Vac/250 Vdc	
300	1500	3000	MHL26300	MHL36300	AL900MA 3-#3/0-500 kcmil
350	1750	3500	MHL26350	MHL36350	
400	2000	4000	MHL26400	MHL36400	
450	2250	4500	MHL26450	MHL36450	
500	2500	5000	MHL26500	MHL36500	
600	3000	6000	MHL26600	MHL36600	
700	3500	7000	MHL26700	MHL36700	
800	4000	8000	MHL26800	MHL36800	
900	4500	9000	MHL26900	MHL36900	
1000	5000	10000	MHL261000	MHL361000	
1200	5100	10200	MAL261200	MAL361200	AL1000MA 4-#1/0-350 kcmil

★ Two pole circuit breaker catalog numbers are completed by adding required phase connection letters as a suffix to the catalog number.

▲ UL magnetic trip setting tolerances are -20% /+30% (Low) and -20% /+30% (High) from the nominal values shown.

### Powerpack<sup>®</sup> Selection Data

For Powerpack selection information see Class 611, 612, 613, and 734 catalogs.



M-frame: Class 612

# Thermal-Magnetic / Magnetic Only Molded Case Circuit Breakers 800 / 1000 Ampere Frame

## Dimensions

Figure 16: MAL, MHL 800 / 1000 Ampere Frame

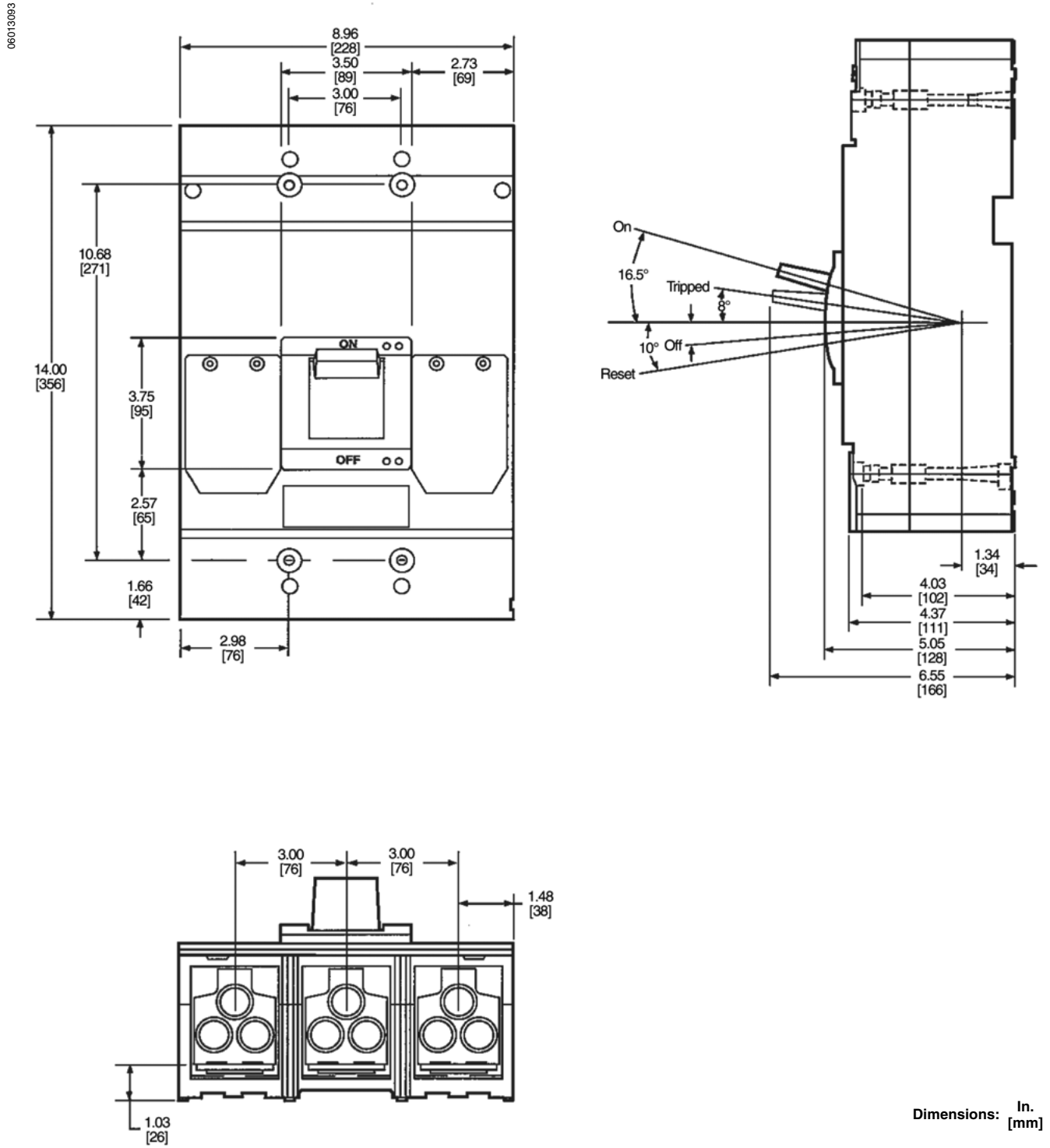

Dimensions: In. [mm]

# Thermal-Magnetic / Magnetic Only Molded Case Circuit Breakers 800 / 1000 Ampere Frame

## Tripping Curves

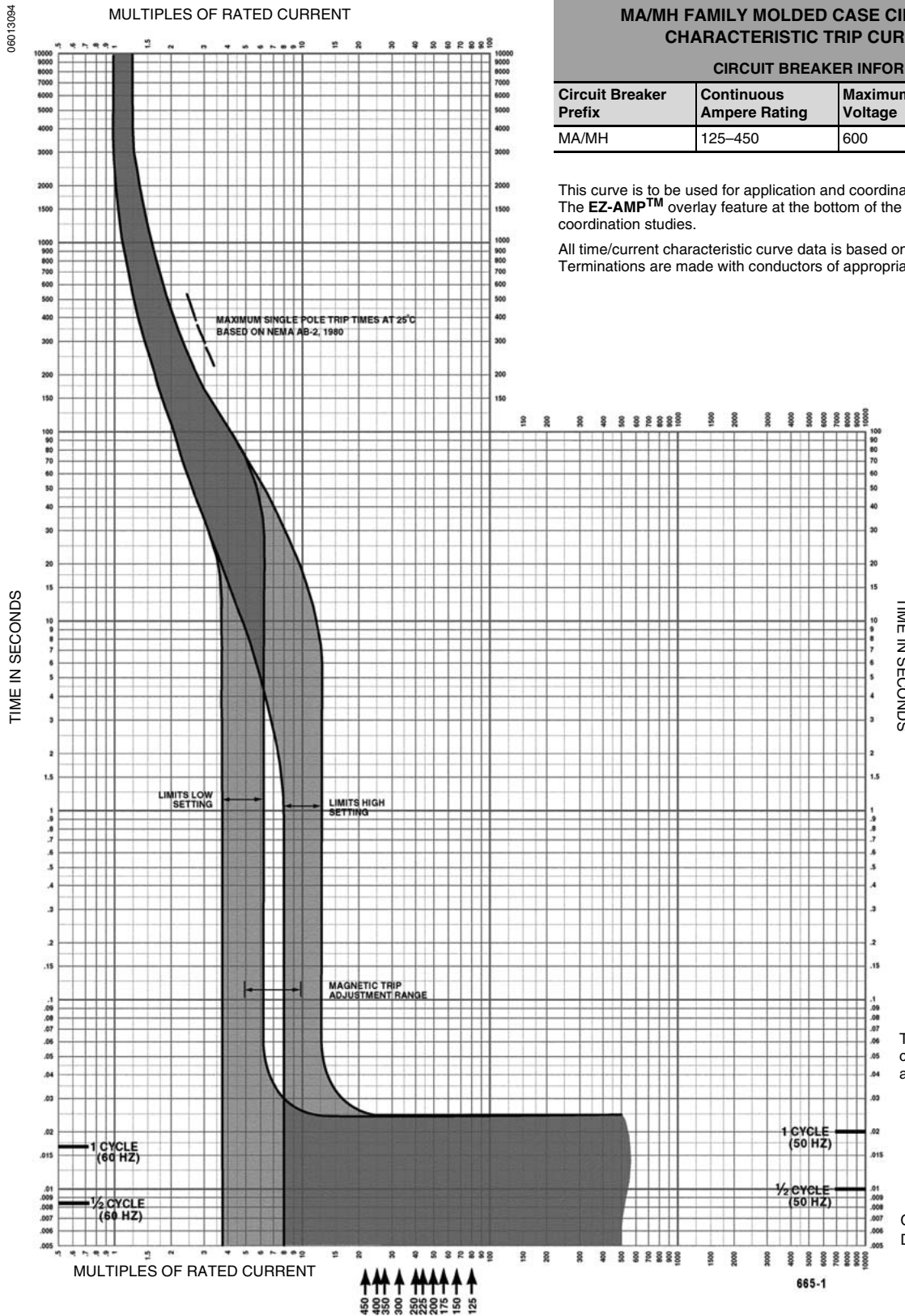

MA/MH FAMILY MOLDED CASE CIRCUIT BREAKERS CHARACTERISTIC TRIP CURVE NO. 665-1			
CIRCUIT BREAKER INFORMATION			
Circuit Breaker Prefix	Continuous Ampere Rating	Maximum AC Voltage	Number of Poles
MA/MH	125-450	600	2, 3

This curve is to be used for application and coordination purposes only. The **EZ-AMP™** overlay feature at the bottom of the page should be used during coordination studies.

All time/current characteristic curve data is based on 40°C ambient cold start. Terminations are made with conductors of appropriate length and ratings.

Tripping curves for coordination studies are available upon request.

Curve No. 0665TC8501  
Drawing No. B48095-665-01

# Thermal-Magnetic / Magnetic Only Molded Case Circuit Breakers 800 / 1000 Ampere Frame

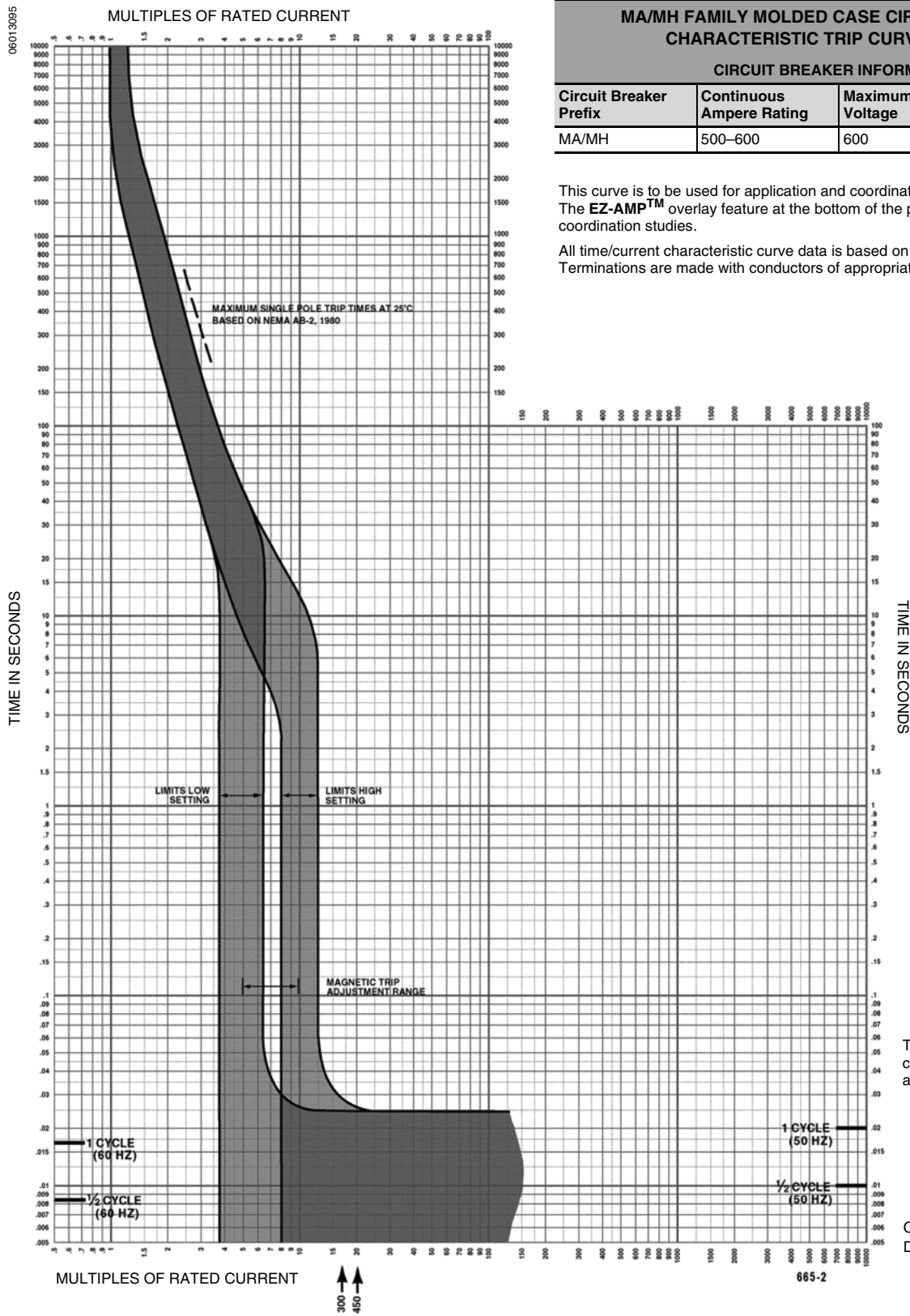

MA/MH FAMILY MOLDED CASE CIRCUIT BREAKERS CHARACTERISTIC TRIP CURVE NO. 665-2			
CIRCUIT BREAKER INFORMATION			
Circuit Breaker Prefix	Continuous Ampere Rating	Maximum AC Voltage	Number of Pole
MA/MH	500-600	600	2, 3

This curve is to be used for application and coordination purposes only. The EZ-AMP™ overlay feature at the bottom of the page should be used during coordination studies.

All time/current characteristic curve data is based on 40°C ambient cold start. Terminations are made with conductors of appropriate length and ratings.

Tripping curves for coordination studies are available upon request.

Curve No. 0665TC8502  
Drawing No. B48095-665-02

# Thermal-Magnetic / Magnetic Only Molded Case Circuit Breakers 800 / 1000 Ampere Frame

## MA/MH FAMILY MOLDED CASE CIRCUIT BREAKERS CHARACTERISTIC TRIP CURVE NO. 665-3

CIRCUIT BREAKER INFORMATION			
Circuit Breaker Prefix	Continuous Ampere Rating	Maximum AC Voltage	Number of Poles
MA/MH	700-1000	600	2, 3

This curve is to be used for application and coordination purposes only. The **EZ-AMP™** overlay feature at the bottom of the page should be used during coordination studies.

All time/current characteristic curve data is based on 40°C ambient cold start. Terminations are made with conductors of appropriate length and ratings.

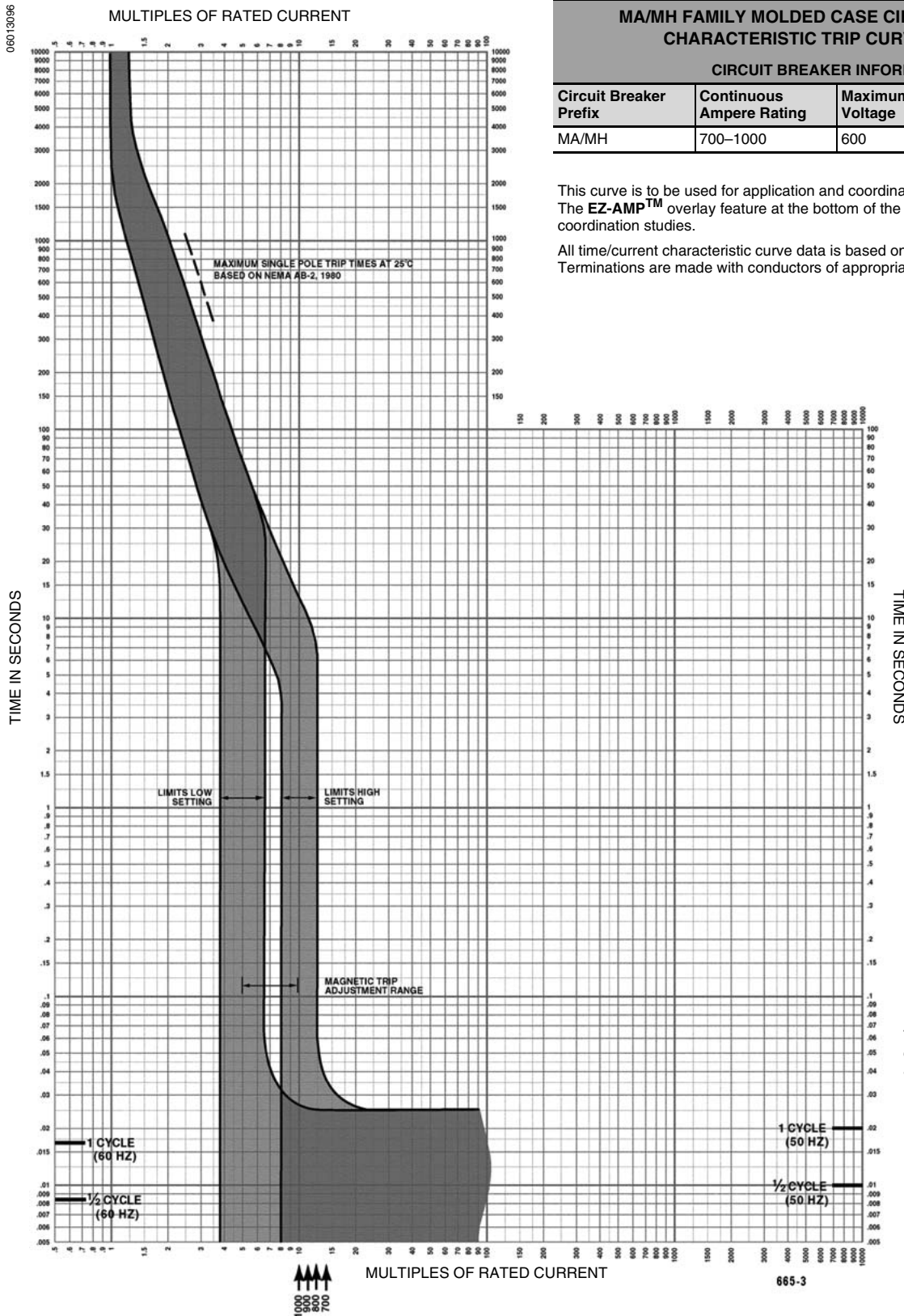

Tripping curves for coordination studies are available upon request.

Curve No. 0665TC8503  
Drawing No. B48095-665-03

# Thermal-Magnetic / Magnetic Only Molded Case Circuit Breakers 800 / 1000 Ampere Frame

06013097

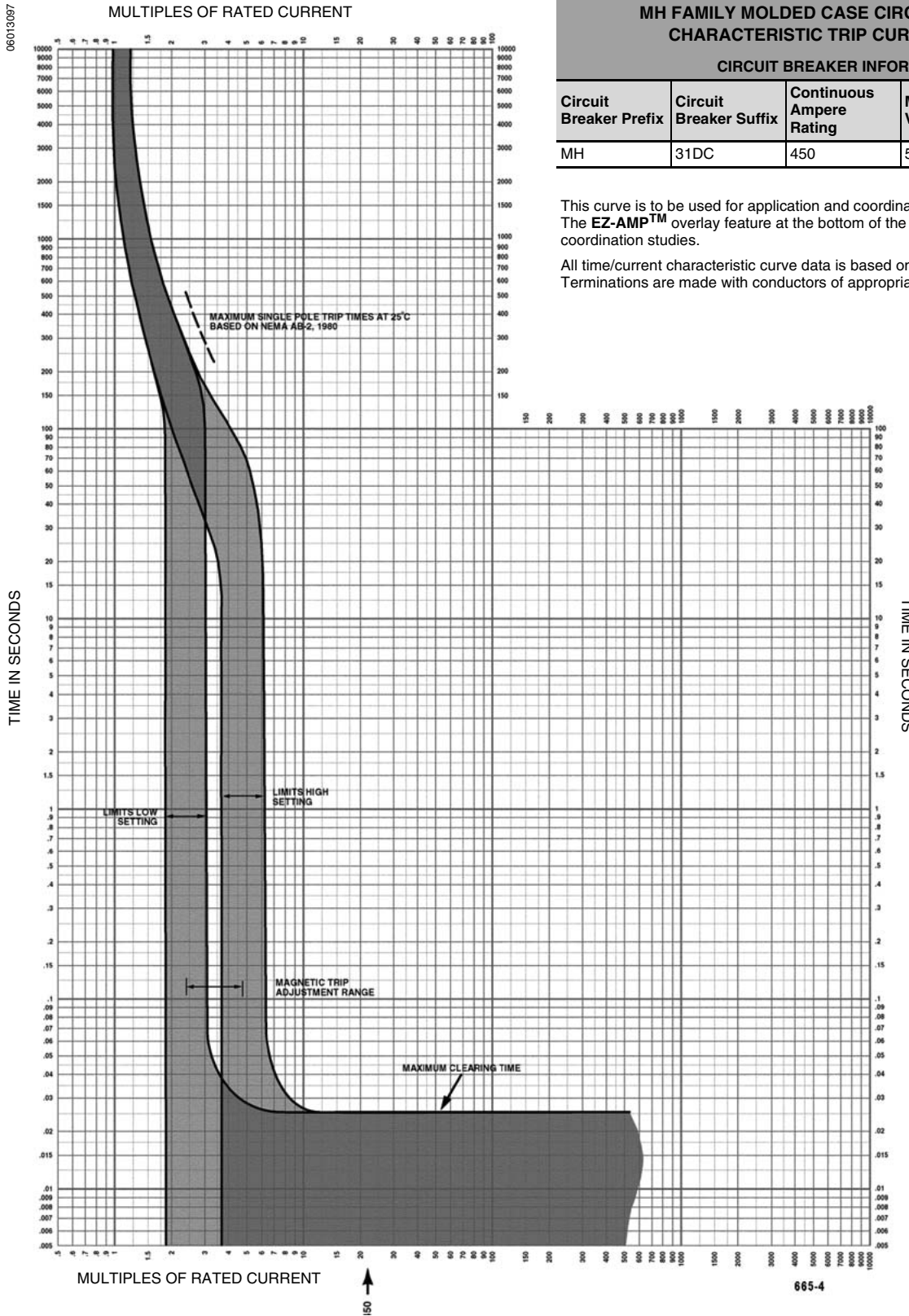

## MH FAMILY MOLDED CASE CIRCUIT BREAKERS CHARACTERISTIC TRIP CURVE NO. 665-4

### CIRCUIT BREAKER INFORMATION

Circuit Breaker Prefix	Circuit Breaker Suffix	Continuous Ampere Rating	Maximum DC Voltage	Number of Poles
MH	31DC	450	500	3

This curve is to be used for application and coordination purposes only. The **EZ-AMP™** overlay feature at the bottom of the page should be used during coordination studies.

All time/current characteristic curve data is based on 40°C ambient cold start. Terminations are made with conductors of appropriate length and ratings.

Tripping curves for coordination studies are available upon request.

Curve No. 0665TC8504  
Drawing No. B48095-665-04

# Thermal-Magnetic / Magnetic Only Molded Case Circuit Breakers 800 / 1000 Ampere Frame

06013098

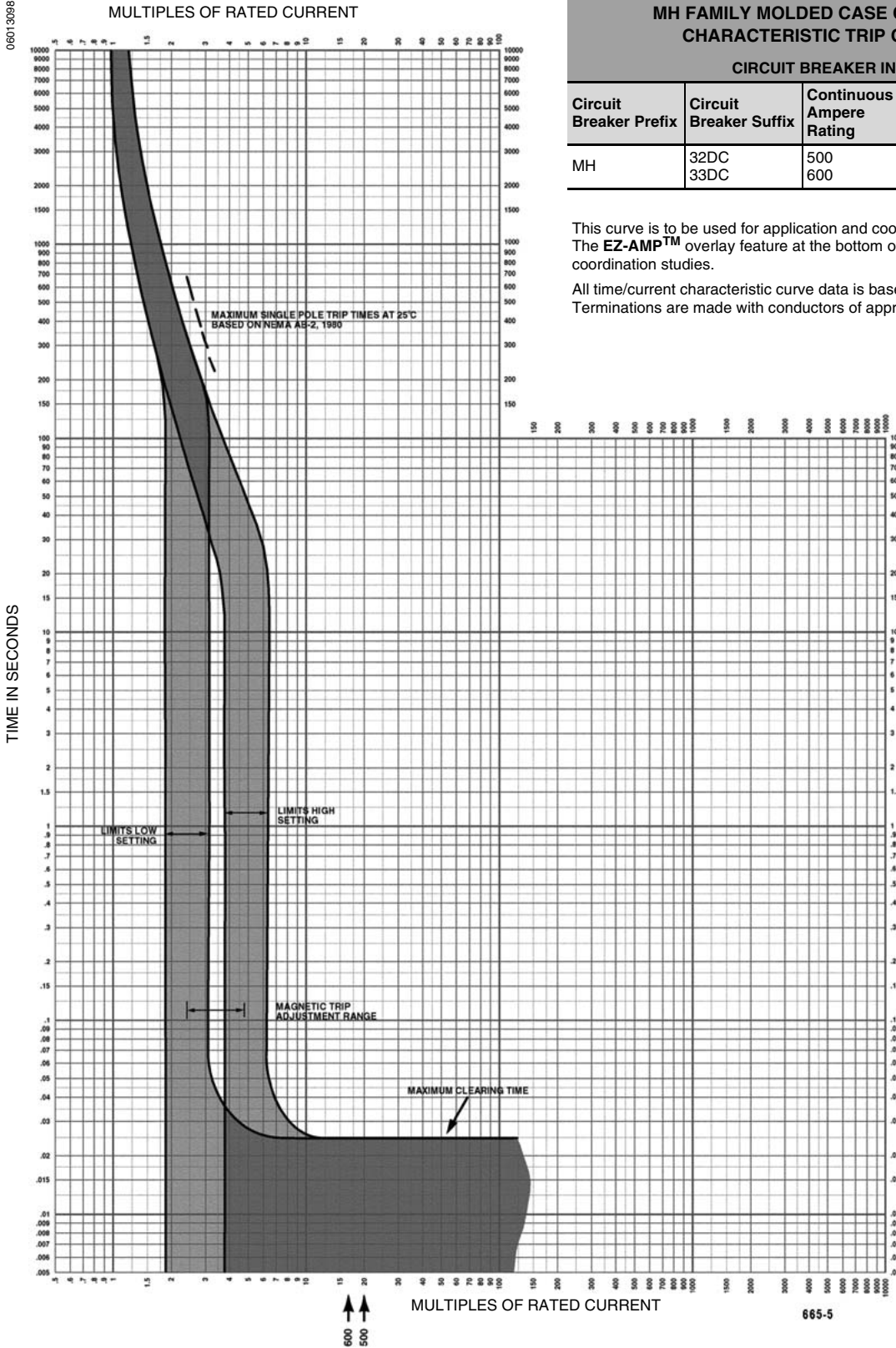

## MH FAMILY MOLDED CASE CIRCUIT BREAKERS CHARACTERISTIC TRIP CURVE NO. 665-5

### CIRCUIT BREAKER INFORMATION

Circuit Breaker Prefix	Circuit Breaker Suffix	Continuous Ampere Rating	Maximum DC Voltage	Number of Poles
MH	32DC 33DC	500 600	500	3

This curve is to be used for application and coordination purposes only. The **EZ-AMP™** overlay feature at the bottom of the page should be used during coordination studies.

All time/current characteristic curve data is based on 40°C ambient cold start. Terminations are made with conductors of appropriate length and ratings.

Tripping curves for coordination studies are available upon request.

Curve No. 0665TC8505  
Drawing No. B48095-665-05

# Thermal-Magnetic / Magnetic Only Molded Case Circuit Breakers 800 / 1000 Ampere Frame

06013099

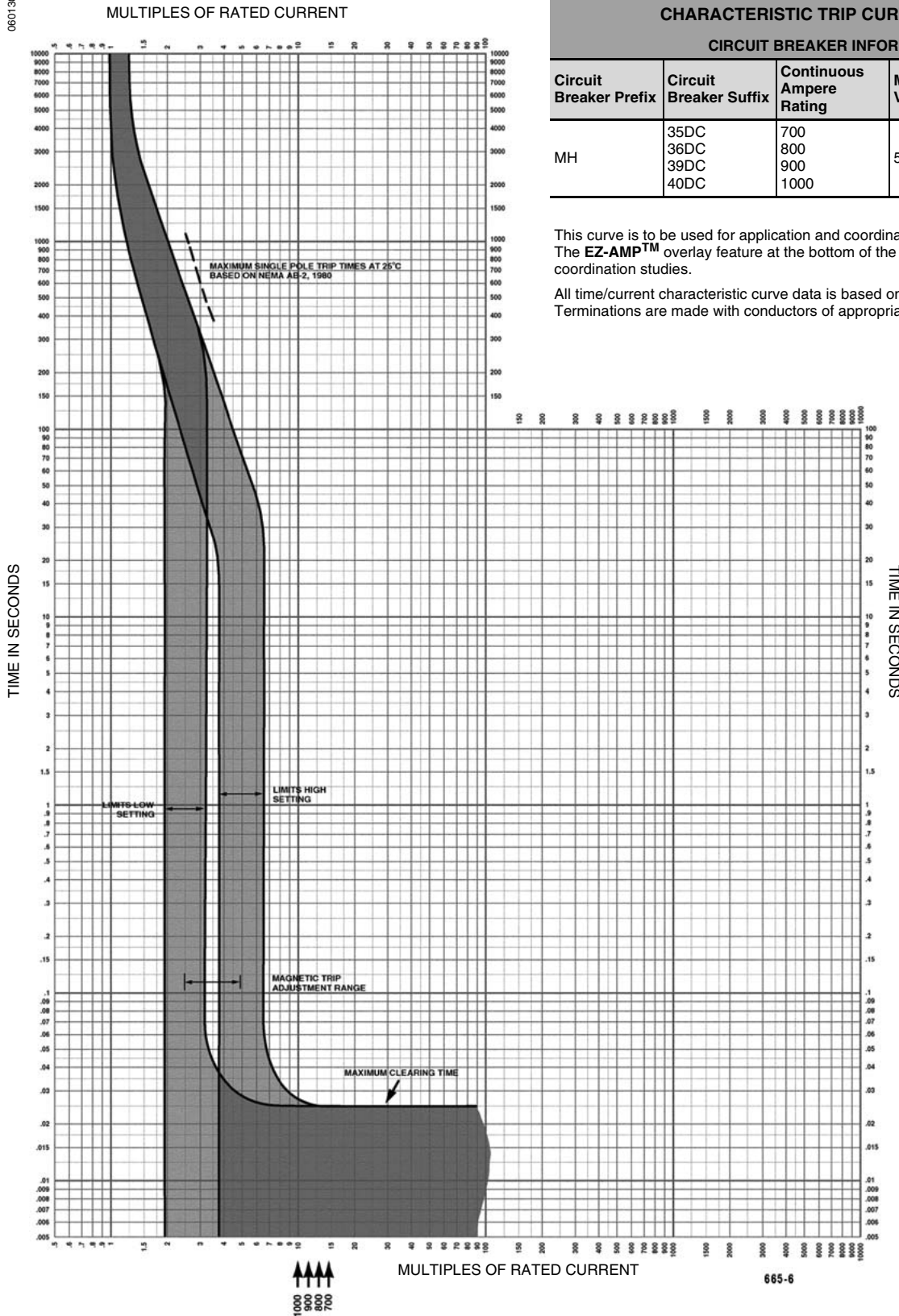

## MH FAMILY MOLDED CASE CIRCUIT BREAKERS CHARACTERISTIC TRIP CURVE NO. 665-6

### CIRCUIT BREAKER INFORMATION

Circuit Breaker Prefix	Circuit Breaker Suffix	Continuous Ampere Rating	Maximum DC Voltage	Number of Poles
MH	35DC 36DC 39DC 40DC	700 800 900 1000	500	3

This curve is to be used for application and coordination purposes only. The **EZ-AMP™** overlay feature at the bottom of the page should be used during coordination studies.

All time/current characteristic curve data is based on 40°C ambient cold start. Terminations are made with conductors of appropriate length and ratings.

Tripping curves for coordination studies are available upon request.

Curve No. 665-6  
May 1989

# Thermal-Magnetic / Magnetic Only Molded Case Circuit Breakers 800 / 1000 Ampere Frame

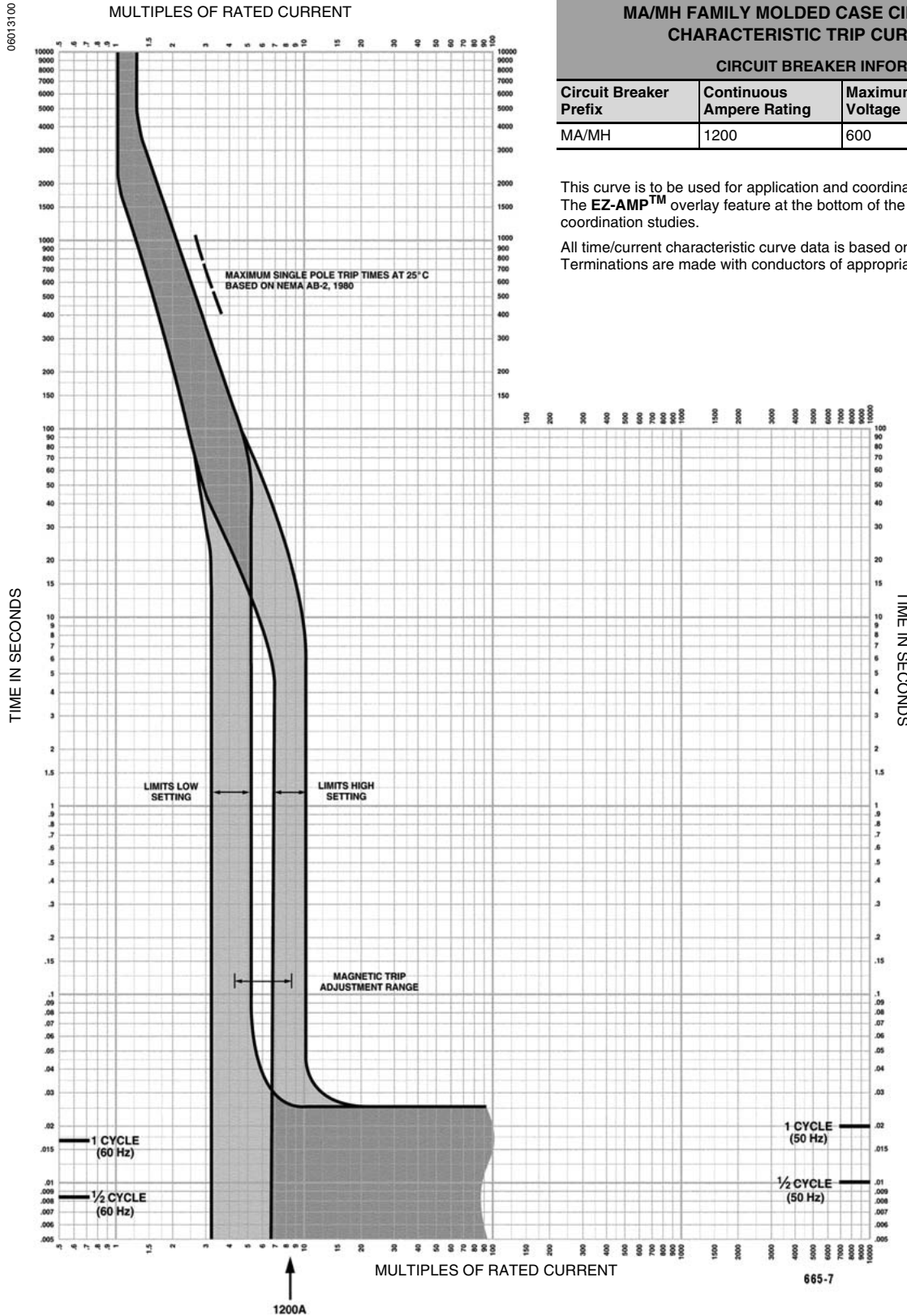

## MA/MH FAMILY MOLDED CASE CIRCUIT BREAKERS CHARACTERISTIC TRIP CURVE NO. 665-7

Circuit Breaker Prefix	Continuous Ampere Rating	Maximum AC Voltage	Number of Pole
MA/MH	1200	600	3

This curve is to be used for application and coordination purposes only. The **EZ-AMP™** overlay feature at the bottom of the page should be used during coordination studies.

All time/current characteristic curve data is based on 40°C ambient cold start. Terminations are made with conductors of appropriate length and ratings.

Tripping curves for coordination studies are available upon request.

Curve No. 0665TC9107  
Drawing No. 48095-665-07

# Thermal-Magnetic / Magnetic Only Molded Case Circuit Breakers 800 / 1000 Ampere Frame

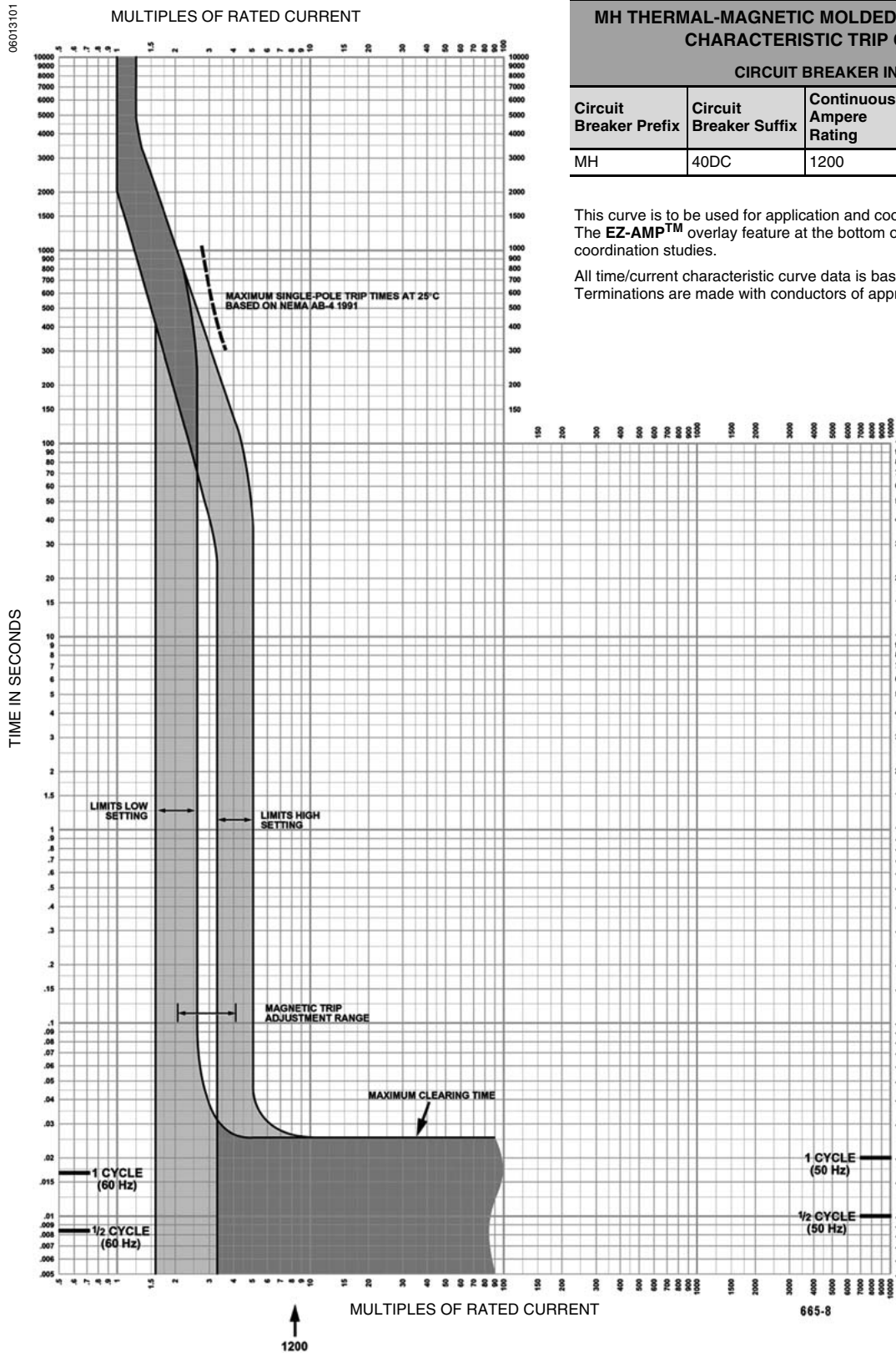

## MH THERMAL-MAGNETIC MOLDED CASE CIRCUIT BREAKERS CHARACTERISTIC TRIP CURVE NO. 665-8

### CIRCUIT BREAKER INFORMATION

Circuit Breaker Prefix	Circuit Breaker Suffix	Continuous Ampere Rating	Maximum DC Voltage	Number of Poles
MH	40DC	1200	500	3

This curve is to be used for application and coordination purposes only. The **EZ-AMP™** overlay feature at the bottom of the page should be used during coordination studies.

All time/current characteristic curve data is based on 40°C ambient cold start. Terminations are made with conductors of appropriate length and ratings.

Tripping curves for coordination studies are available upon request.

Curve No. 0665TC8508  
March 2001  
Drawing No. B48095-665-08  
(Replaces 0655TC9108)

# Thermal-Magnetic / Magnetic Only Molded Case Circuit Breakers 800 / 1000 Ampere Frame

## Powerpack® Tripping Curves

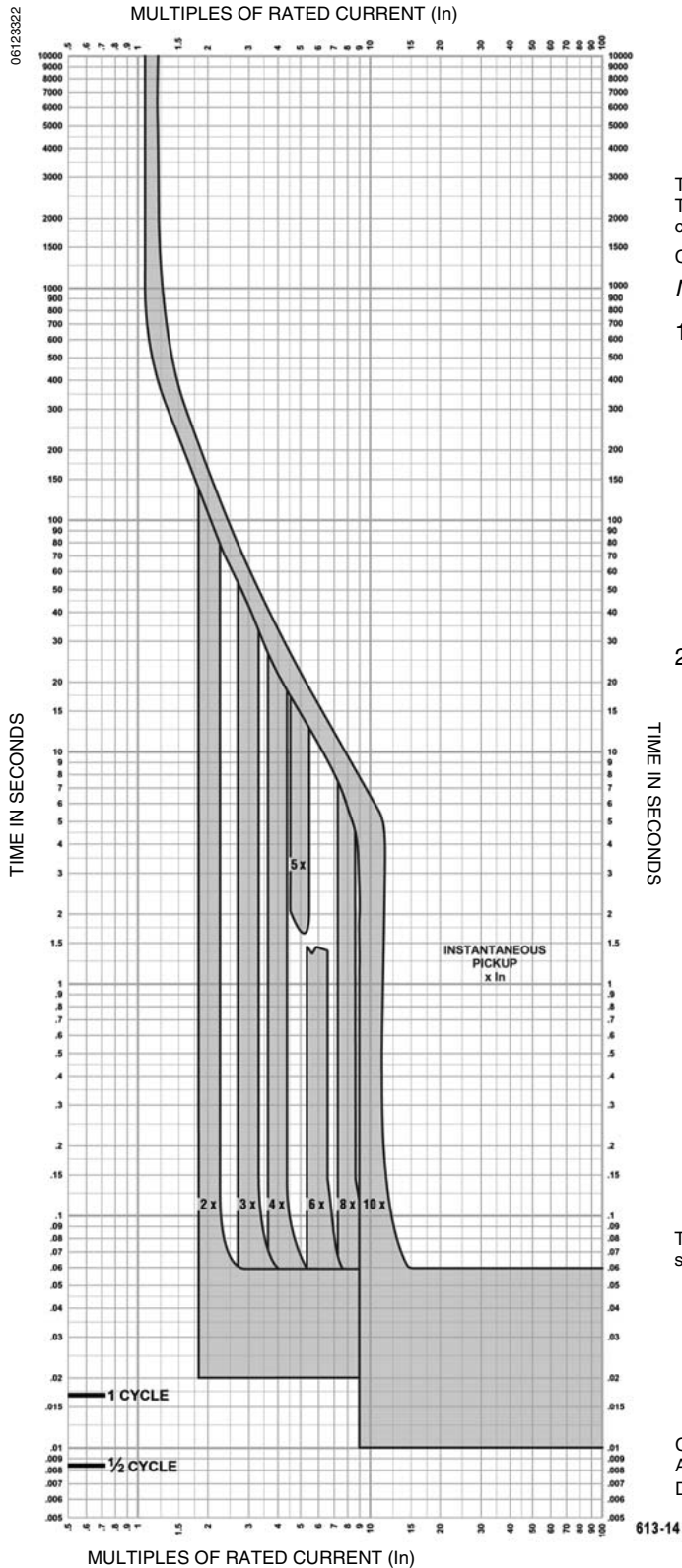

### ELECTRONIC TRIP 1.0 CHARACTERISTIC TRIP CURVE NO. 613-14

#### CIRCUIT BREAKER INFORMATION

Long-time Pickup and Delay  
Instantaneous Pickup and Delay  
2x-10x

This curve is to be used for application and coordination purposes only. The **EZ-AMP™** overlay feature at the bottom of the page should be used during coordination studies.

Curves apply from -30°C to +60°C ambient temperature.

**NOTE:**

1. There is a thermal-imaging effect that can act to shorten the long-time delay. The thermal-imaging effect comes into play if a current above the long-time delay pickup value exists for a time and then is cleared by the tripping of a downstream device or the circuit breaker itself. A subsequent overload will cause the circuit breaker to trip in a shorter time than normal. The amount of time delay reduction is inverse to the amount of time that has elapsed since the previous overload. Approximately 20 minutes is required between overloads to completely reset thermal-imaging.
2. Total clearing times shown include the response times of the trip unit, the circuit breaker opening, and the extinction of the current.

Tripping curves for coordination studies are available upon request.

Curve No. 0613TC0114  
April 2001  
Drawing No. B48095-613-14

# Thermal-Magnetic / Magnetic Only Molded Case Circuit Breakers 800 / 1000 Ampere Frame

## MICROLOGIC® 6.0 A/P/H TRIP UNIT WITH ADJUSTABLE GROUND-FAULT PICKUP AND DELAY CHARACTERISTIC TRIP CURVE NO. 613-1

Ground-fault  $I^2t$  OFF and ON in  $\leq 400$  Ampere

This curve is to be used for application and coordination purposes only.  
Curves apply from -30°C to +60°C ambient temperature.

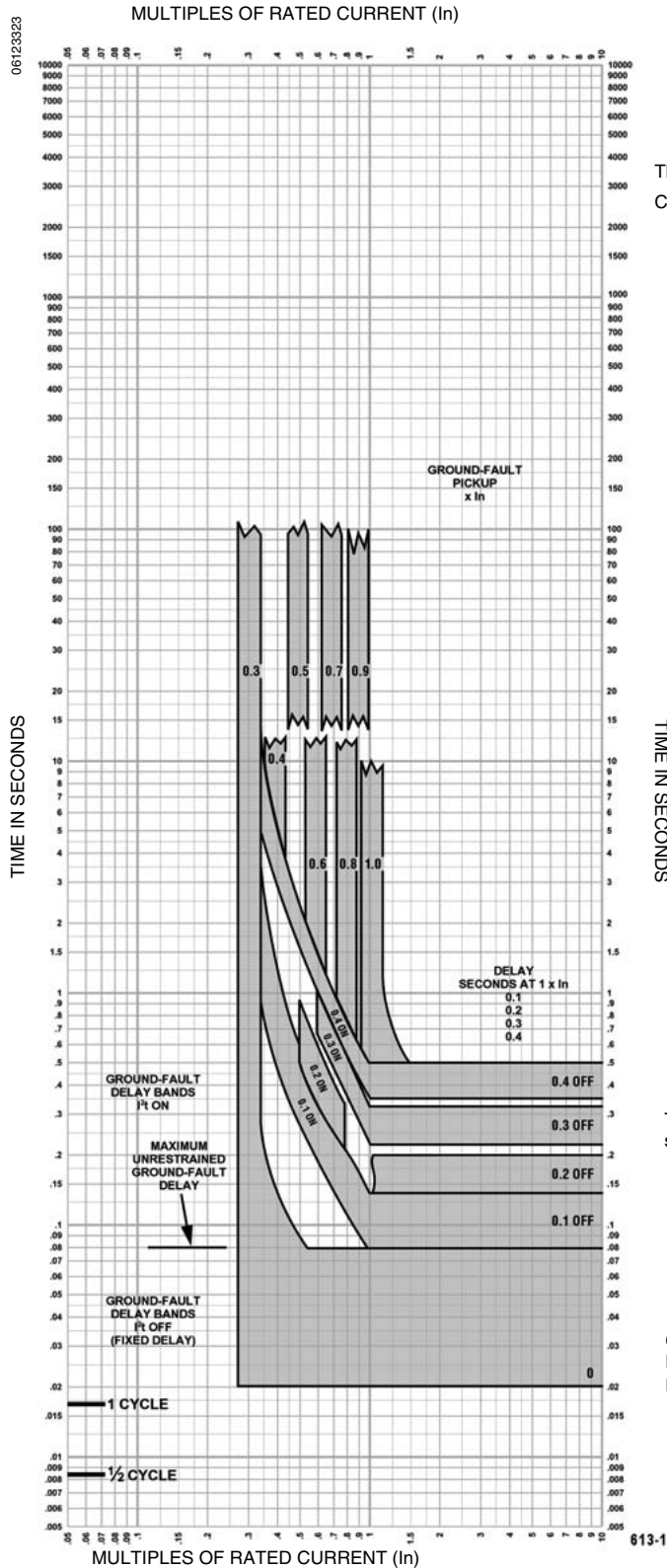

Tripping curves for coordination studies are available upon request.

Curve No. 0613TC0001  
December 2000  
Drawing No. B48095-613-01

# Thermal-Magnetic / Magnetic Only Molded Case Circuit Breakers 1200 Ampere Frame

## 1200 AMPERE FRAME

This section provides specific information on Square D® 1200 ampere frame thermal-magnetic molded case circuit breakers. For more information, see the Introduction in this catalog.

### Description

**Table 37: Description of 1200 Ampere Frame Circuit Breakers**

Circuit Breaker	Description
NA/NC	600–1200 ampere, 600 Vac, 50/60 Hz, 2- and 3-pole

### Applications

NA and NC circuit breakers are used in industrial enclosures, panelboards and switchboards.

**Table 38: 1200 Ampere Frame Interrupting Ratings**

Catalog Number Prefix		No. of Poles	Cont. Ampere Rating	UL Listed Interrupting Rating (kA)					Federal Specs. W-C-375B/GEN	IEC 60947-2 Icu/Ics (kA) AC Voltage
				AC Volts - RMS Symmetrical Amperes						
Unit Mount	I-Line®			120	240	480Y/277	480	600		415/240
NAL	NA	2, 3	600–1200	100	100	50	50	25	23a	50/25
NCL	NC	2, 3	600–1200	125	125	100	100	65	25a	70/35

### Selection Data

**Table 39: 1200 Ampere Unit Mount Circuit Breakers**

Ampere Rating	AC Magnetic Trip Settings Amperes		Two Pole Catalog No.	Three Pole Catalog No.	Standard Lug Kit Wire Range
<b>NAL High Interrupting</b>					
	Low	High	600 Vac	600 Vac	
600	4000	8000	NAL26600	NAL36600	AL1200NE6 4-#3/0-600 kcmil
700	4000	8000	NAL26700	NAL36700	
800	4000	8000	NAL26800	NAL36800	
900	5000	10000	NAL26900	NAL36900	
1000	5000	10000	NAL261000	NAL361000	
1200	5000	10000	NAL261200	NAL361200	
<b>NCL Extra High Interrupting</b>					
	Low	High	600 Vac	600 Vac	
600	4000	8000	NCL26600	NCL36600	AL1200NE6 4-#3/0-600 kcmil
700	4000	8000	NCL26700	NCL36700	
800	4000	8000	NCL26800	NCL36800	
900	5000	10000	NCL26900	NCL36900	
1000	5000	10000	NCL261000	NCL361000	
1200	5000	10000	NCL261200	NCL361200	



06013102  
**NAL/NCL**  
Two- and Three-pole  
600–1200 Amperes

# Thermal-Magnetic / Magnetic Only Molded Case Circuit Breakers 1200 Ampere Frame

**Table 40: 1200 Ampere Frame I-Line® Circuit Breakers**

Ampere Rating	AC Magnetic Trip Settings Amperes <sup>▲</sup>		Two Pole <sup>★</sup> Catalog No.	Three Pole Catalog No.	Standard Lug Kit Wire Range
<b>NA High Interrupting</b>					
	Low	High	240 Vac	240 Vac	
600	4000	8000	NA26600( )	NA36600	AL1200NE6 4-#3/0-600 kcmil
700	4000	8000	NA26700( )	NA36700	
800	4000	8000	NA26800( )	NA36800	
900	5000	10000	NA26900( )	NA36900	
1000	5000	10000	NA261000( )	NA361000	
1200	5000	10000	NA261200( )	NA361200	
<b>NC Extra High Interrupting</b>					
	Low	High	600 Vac/250 Vdc	600 Vac/250 Vdc	
600	4000	8000	NC26600( )	NC36600	AL1200NE6 4-#3/0-600 kcmil
700	4000	8000	NC26700( )	NC36700	
800	4000	8000	NC26800( )	NC36800	
900	5000	10000	NC26900( )	NC36900	
1000	5000	10000	NC261000( )	NC361000	
1200	5000	10000	NC261200( )	NC361200	

<sup>★</sup> Two pole circuit breaker catalog numbers are completed by adding required phase connection letters as a suffix to the catalog number.

<sup>▲</sup> UL magnetic trip setting tolerances are -20% /+30% (Low) and -20% /+30% (High) from the nominal values shown.



06013103  
**NA/NC  
Two- and Three-pole  
15" Mounting Height  
600-1200 Amperes**



# Thermal-Magnetic / Magnetic Only Molded Case Circuit Breakers 1200 Ampere Frame

## Tripping Curves

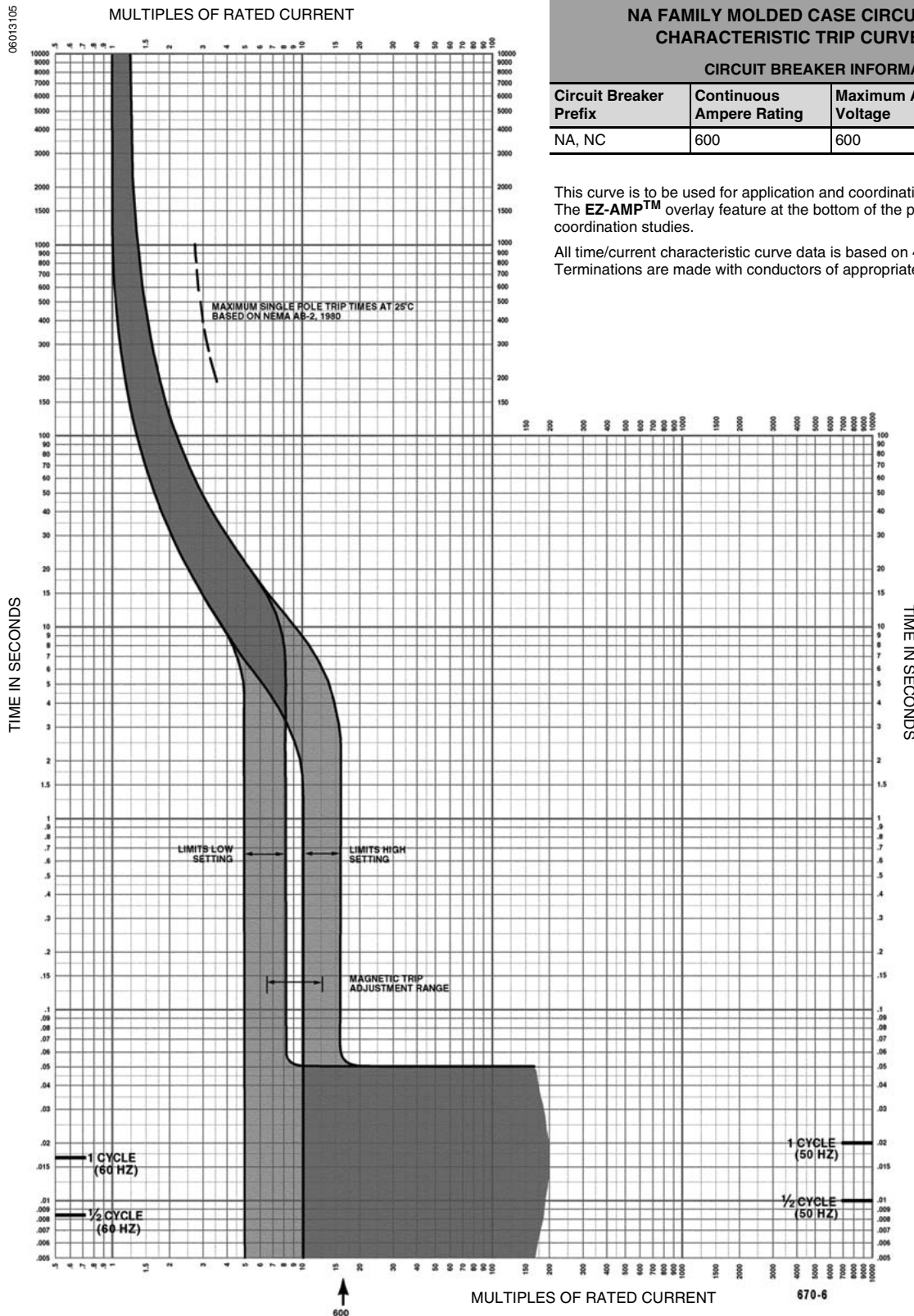

### NA FAMILY MOLDED CASE CIRCUIT BREAKERS CHARACTERISTIC TRIP CURVE NO. 670-6

#### CIRCUIT BREAKER INFORMATION

Circuit Breaker Prefix	Continuous Ampere Rating	Maximum AC Voltage	Number of Poles
NA, NC	600	600	2, 3

This curve is to be used for application and coordination purposes only. The **EZ-AMP™** overlay feature at the bottom of the page should be used during coordination studies.

All time/current characteristic curve data is based on 40°C ambient cold start. Terminations are made with conductors of appropriate length and ratings.

Tripping curves for coordination studies are available upon request.

Curve No. 0670TC8706  
Drawing No. 48095-670-06

# Thermal-Magnetic / Magnetic Only Molded Case Circuit Breakers 1200 Ampere Frame

06013106

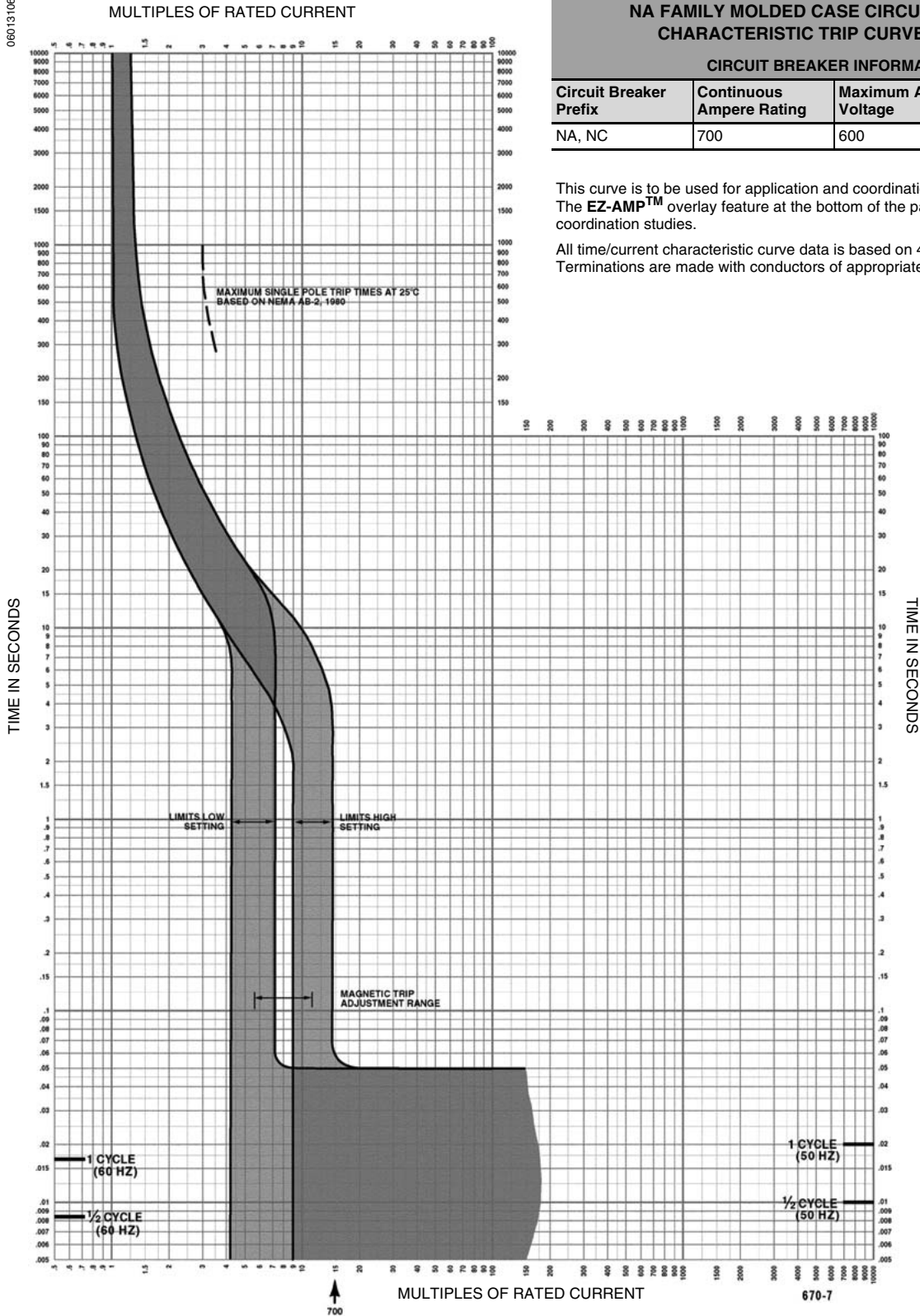

## NA FAMILY MOLDED CASE CIRCUIT BREAKERS CHARACTERISTIC TRIP CURVE NO. 670-7

CIRCUIT BREAKER INFORMATION			
Circuit Breaker Prefix	Continuous Ampere Rating	Maximum AC Voltage	Number of Poles
NA, NC	700	600	2, 3

This curve is to be used for application and coordination purposes only. The **EZ-AMP™** overlay feature at the bottom of the page should be used during coordination studies.

All time/current characteristic curve data is based on 40°C ambient cold start. Terminations are made with conductors of appropriate length and ratings.

Tripping curves for coordination studies are available upon request.

Curve No. 0670TC8707  
Drawing No. 48095-670-07

# Thermal-Magnetic / Magnetic Only Molded Case Circuit Breakers 1200 Ampere Frame

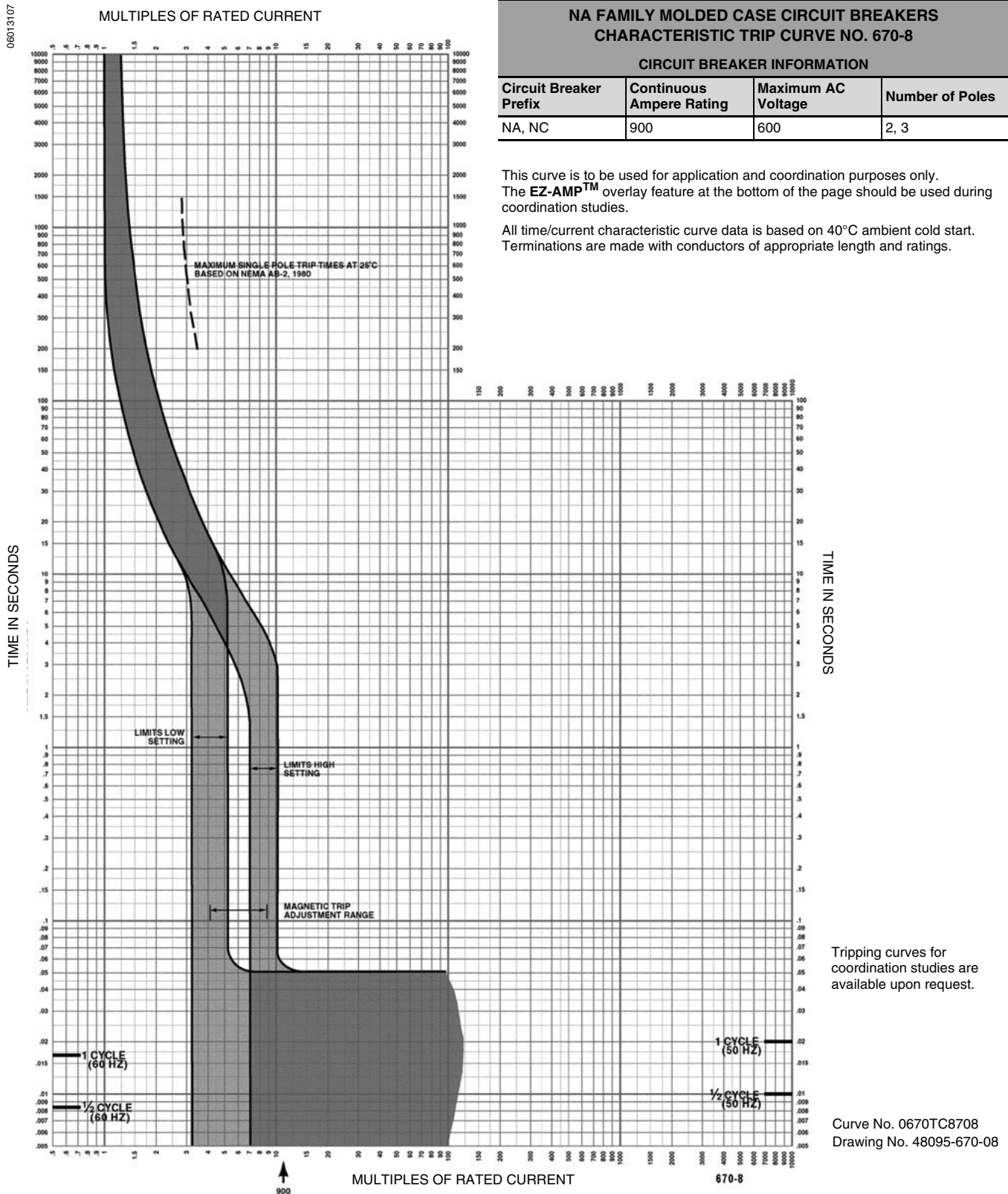

## NA FAMILY MOLDED CASE CIRCUIT BREAKERS CHARACTERISTIC TRIP CURVE NO. 670-8

CIRCUIT BREAKER INFORMATION			
Circuit Breaker Prefix	Continuous Ampere Rating	Maximum AC Voltage	Number of Poles
NA, NC	900	600	2, 3

This curve is to be used for application and coordination purposes only. The **EZ-AMP™** overlay feature at the bottom of the page should be used during coordination studies.

All time/current characteristic curve data is based on 40°C ambient cold start. Terminations are made with conductors of appropriate length and ratings.

Tripping curves for coordination studies are available upon request.

Curve No. 0670TC8708  
Drawing No. 48095-670-08

# Thermal-Magnetic / Magnetic Only Molded Case Circuit Breakers 1200 Ampere Frame

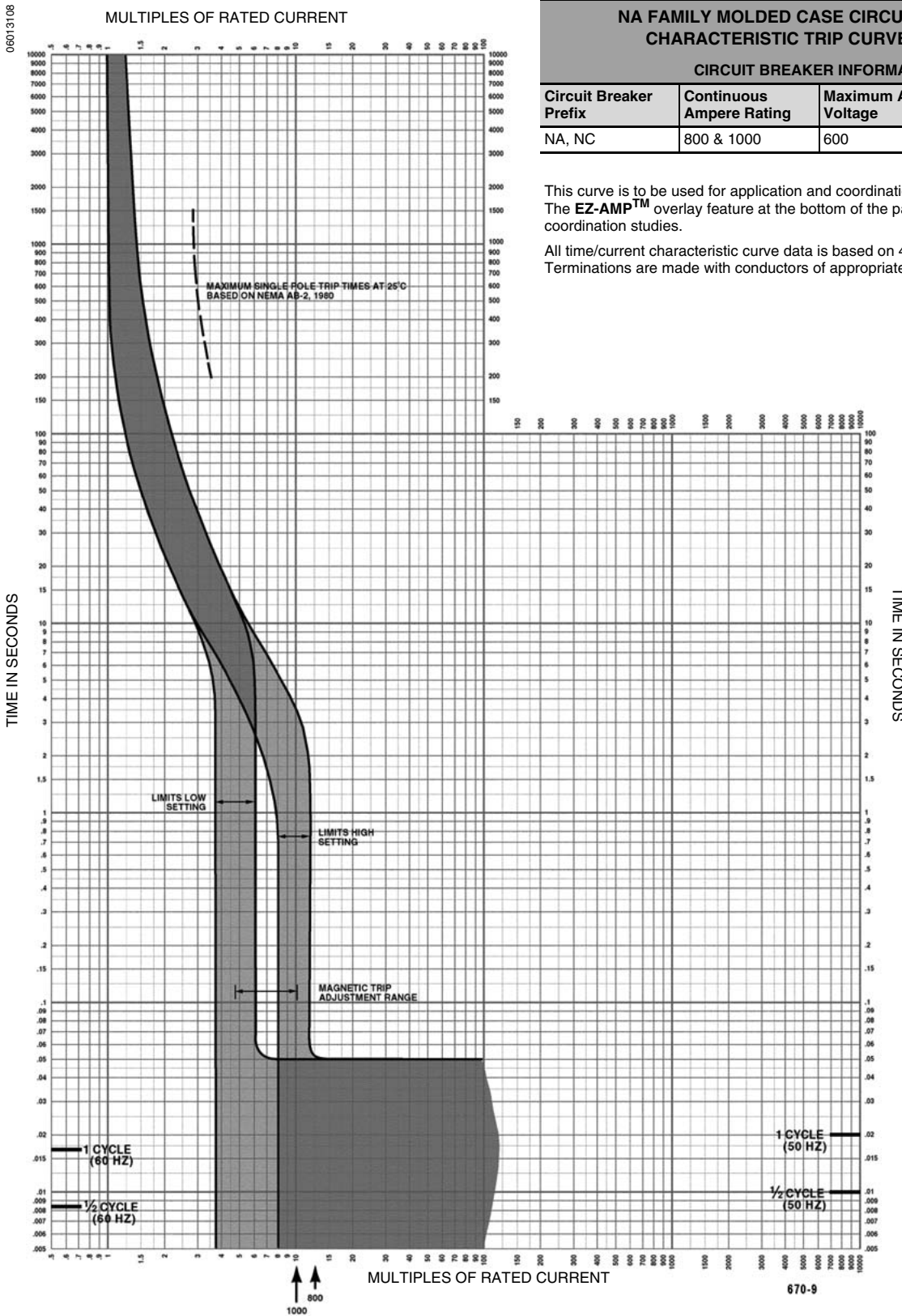

## NA FAMILY MOLDED CASE CIRCUIT BREAKERS CHARACTERISTIC TRIP CURVE NO. 670-9

### CIRCUIT BREAKER INFORMATION

Circuit Breaker Prefix	Continuous Ampere Rating	Maximum AC Voltage	Number of Poles
NA, NC	800 & 1000	600	2, 3

This curve is to be used for application and coordination purposes only. The **EZ-AMP™** overlay feature at the bottom of the page should be used during coordination studies.

All time/current characteristic curve data is based on 40°C ambient cold start. Terminations are made with conductors of appropriate length and ratings.

Tripping curves for coordination studies are available upon request.

Curve No. 0670TC8709  
Drawing No. 48095-670-09

# Thermal-Magnetic / Magnetic Only Molded Case Circuit Breakers 1200 Ampere Frame

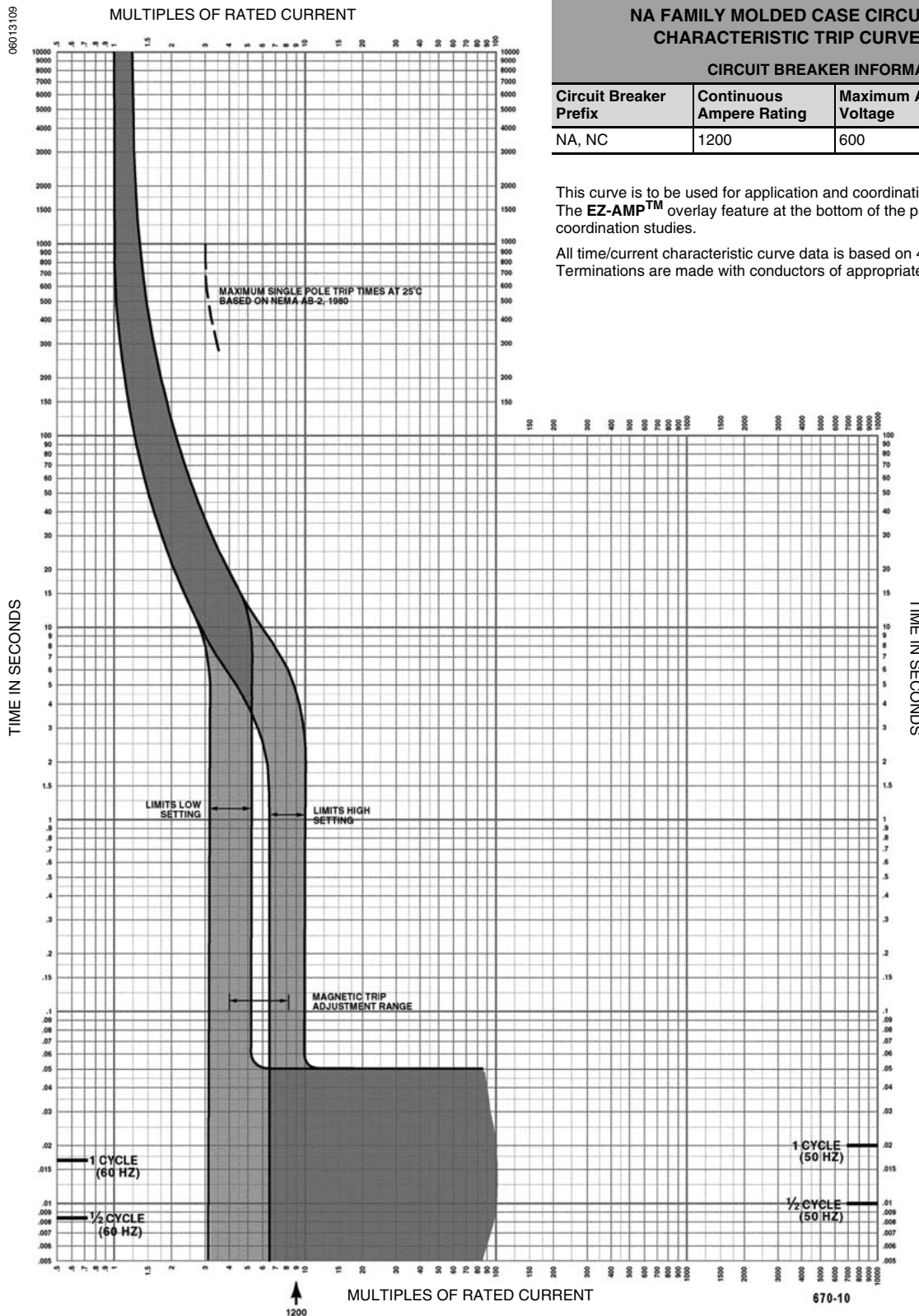

## NA FAMILY MOLDED CASE CIRCUIT BREAKERS CHARACTERISTIC TRIP CURVE NO. 670-10

CIRCUIT BREAKER INFORMATION			
Circuit Breaker Prefix	Continuous Ampere Rating	Maximum AC Voltage	Number of Poles
NA, NC	1200	600	2, 3

This curve is to be used for application and coordination purposes only. The **EZ-AMP™** overlay feature at the bottom of the page should be used during coordination studies.

All time/current characteristic curve data is based on 40°C ambient cold start. Terminations are made with conductors of appropriate length and ratings.

Tripping curves for coordination studies are available upon request.

Curve No. 0670TC8710  
Drawing No. 48095-670-10

# Thermal-Magnetic / Magnetic Only Molded Case Circuit Breakers 2000 / 2500 Ampere Frame

## 2000 / 2500 AMPERE FRAME

This section provides specific information on Square D® 2000 / 2500 ampere frame thermal-magnetic molded case circuit breakers. For more information, see the Introduction in this catalog.

### Description

**Table 41: Description of 2000 / 2500 Ampere Frame Circuit Breakers**

Circuit Breaker	Description
PAF/PHF	600–2000 ampere, 600 Vac, 50/60 Hz, 2- and 3- pole
PCF	600–2500 ampere, 600 Vac, 50/60 Hz, 2- and 3-pole

### Applications

PAF, PHF and PCF circuit breakers are used in industrial enclosures, switchboards and busway plug-in units.

**Table 42: 2000 / 2500 Ampere Frame Interrupting Ratings**

Catalog Number Prefix	No. of Poles	Cont. Ampere Rating	UL Listed Interrupting Rating (kA)						Federal Specs. W-C-375B/GEN	IEC 60947-2 Icu/Ics (kA) AC Voltage
			AC Volts - RMS Symmetrical Amperes							
Unit Mount			120	240	480Y/277	480	600	500		415/240
PAF	2, 3	600–1200	65	65	50	50	42	—	24a	50
PAF-DC	3	1200–2000	—	—	—	—	—	25K	—	—
PHF★	2, 3	600–2000	125	125	100	100	65	—	25a	100
PCF★	2, 3	1600–2500	125	125	100	100	65	—	25a	100

★ Separate UL rating available for 240 Vac and 480 Vac grounded B single phase systems. Breakers must be ordered with 5861 suffix. See *Supplemental Digest* for specific ratings.

### Selection Data

**Table 43: 2000 Ampere Unit Mount Circuit Breakers**

Ampere Rating	AC Magnetic Trip Settings Amperes★		Two Pole - 600 Vac		Three Pole - 600 Vac	
			Frame Only	Rating Columns Two Per Kit	Frame Only	Rating Columns Three Per Kit
	Low	High	Catalog No.	Kit Catalog No.	Catalog No.	Kit Catalog No.
<b>PAF Standard Interrupting - Complete Breaker Requires Frame and Rating Columns</b>						
600	3200	9000		PA2600RC		PA3600RC
700	3200	9000		PA2700RC		PA3700RC
800	3200	9000		PA2800RC		PA3800RC
1000	3500	9000		PA21000RC		PA31000RC
1200	3500	9000	PAF2026	PA21200RC	PAF2036	PA31200RC
1400	4500	9000		PA21400RC		PA31400RC
1600	5000	10000		PA21600RC		PA31600RC
1800	6500	11000		PA21800RC		PA31800RC
2000	8000	12000		PA22000RC		PA32000RC

*Continued on next page*



**PAF/PHF  
Two- and Three-pole  
600–2000 Amperes**

# Thermal-Magnetic / Magnetic Only Molded Case Circuit Breakers 2000 / 2500 Ampere Frame

**Table 43: 2000 Ampere Unit Mount Circuit Breakers (continued)**

Ampere Rating	AC Magnetic Trip Settings Amperes <sup>★</sup>		Two Pole - 600 Vac		Three Pole - 600 Vac	
			Frame Only	Rating Columns Two Per Kit	Frame Only	Rating Columns Three Per Kit
			Catalog No.	Kit Catalog No.	Catalog No.	Kit Catalog No.
	Low	High				
<b>PHF High Interrupting - Complete Breaker Requires Frame and Rating Columns</b>						
600	3200	9000	PHF2026	PA2600RC	PHF2036	PA3600RC
700	3200	9000		PA2700RC		PA3700RC
800	3200	9000		PA2800RC		PA3800RC
1000	3500	9000		PA21000RC		PA31000RC
1200	3500	9000		PA21200RC		PA31200RC
1400	4500	9000		PA21400RC		PA31400RC
1600	5000	10000		PA21600RC		PA31600RC
1800	6500	11000		PA21800RC		PA31800RC
2000	8000	12000		PA22000RC		PA32000RC

<sup>★</sup> UL magnetic trip setting tolerances are -20% /+30% (Low) and -20% /+30% (High) from the nominal values shown.

**Table 44: 2500 Ampere Unit Mount Circuit Breakers**

Ampere Rating	AC Magnetic Trip Settings Amperes <sup>★</sup>		Two Pole - 600 Vac		Three Pole - 600 Vac	
			Frame Only	Rating Columns Two Per Kit	Frame Only	Rating Columns Three Per Kit
			Catalog No.	Kit Catalog No.	Catalog No.	Kit Catalog No.
	Low	High				
<b>PCF High Interrupting - Complete Breaker Requires Frame and Rating Columns</b>						
1600	6000	12000	PCF2526	PC21600RC	PCF2536	PC31600RC
1800	6000	12000		PC21800RC		PC31800RC
2000	6000	12000		PC22000RC		PC32000RC
2500	8000	14000		PC22500RC		PC32500RC

<sup>★</sup> UL magnetic trip setting tolerances are -20% /+30% (Low) and -20% /+30% (High) from the nominal values shown.

**Figure 18: PAF/PCF Circuit Breaker with Terminal Pad Kit**

06013111

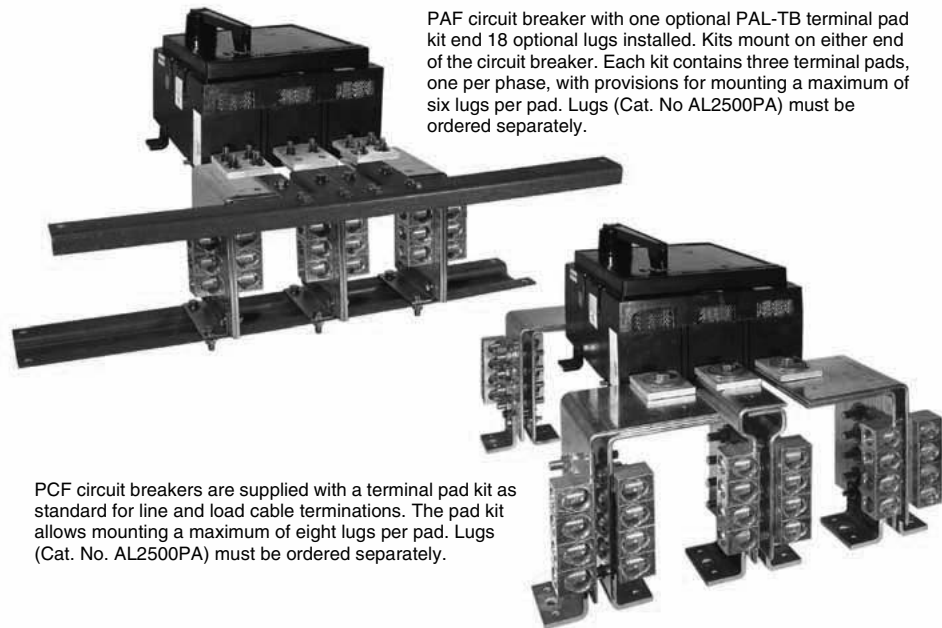

PAF circuit breaker with one optional PAL-TB terminal pad kit and 18 optional lugs installed. Kits mount on either end of the circuit breaker. Each kit contains three terminal pads, one per phase, with provisions for mounting a maximum of six lugs per pad. Lugs (Cat. No. AL2500PA) must be ordered separately.

PCF circuit breakers are supplied with a terminal pad kit as standard for line and load cable terminations. The pad kit allows mounting a maximum of eight lugs per pad. Lugs (Cat. No. AL2500PA) must be ordered separately.

# Thermal-Magnetic / Magnetic Only Molded Case Circuit Breakers 2000 / 2500 Ampere Frame

## Dimensions

Figure 19: PAF, PHF 2000 Ampere Frame

06013112

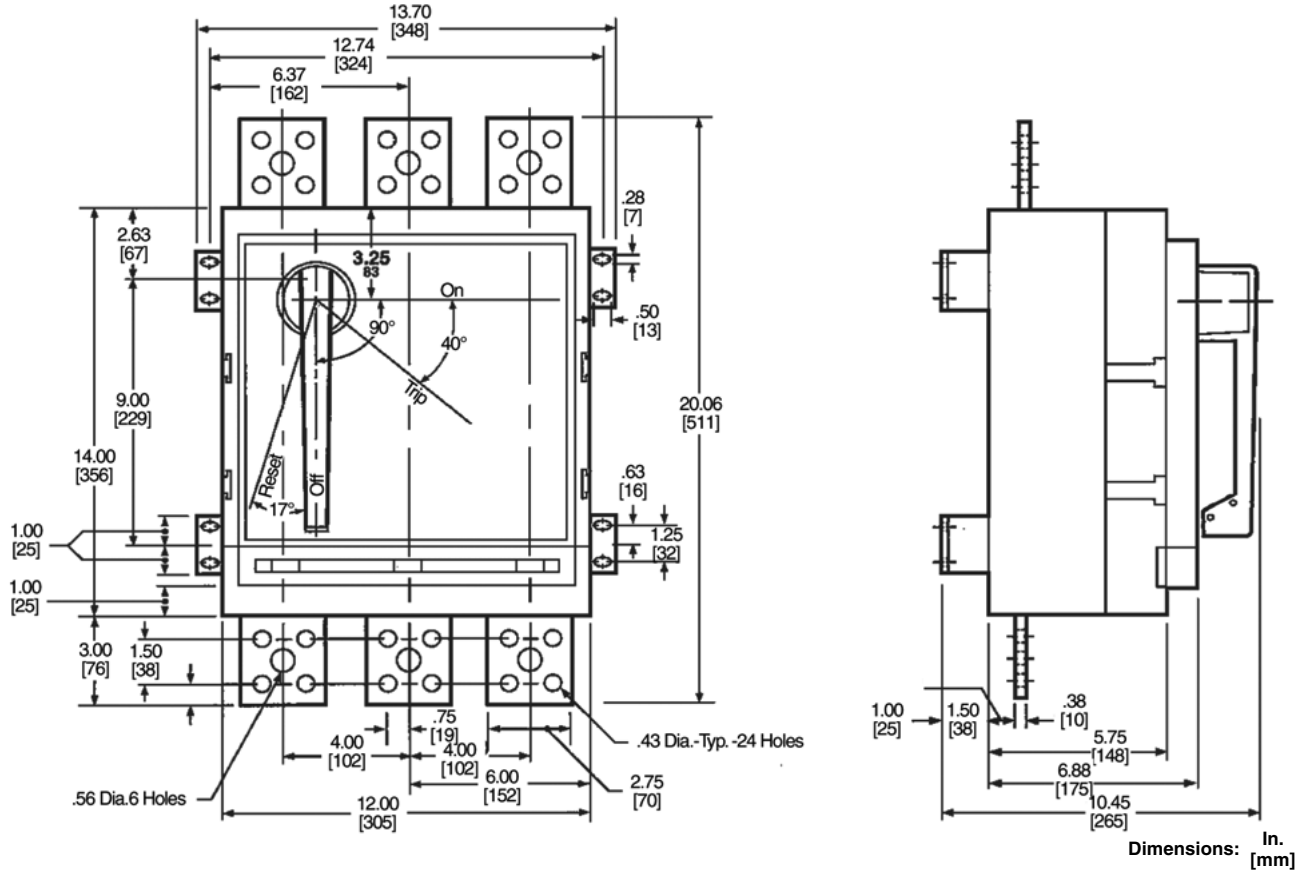

# Thermal-Magnetic / Magnetic Only Molded Case Circuit Breakers 2000 / 2500 Ampere Frame

Figure 20: Circuit Breaker with Terminal Pads—PALTB for PAF, PHF Ampere Frame

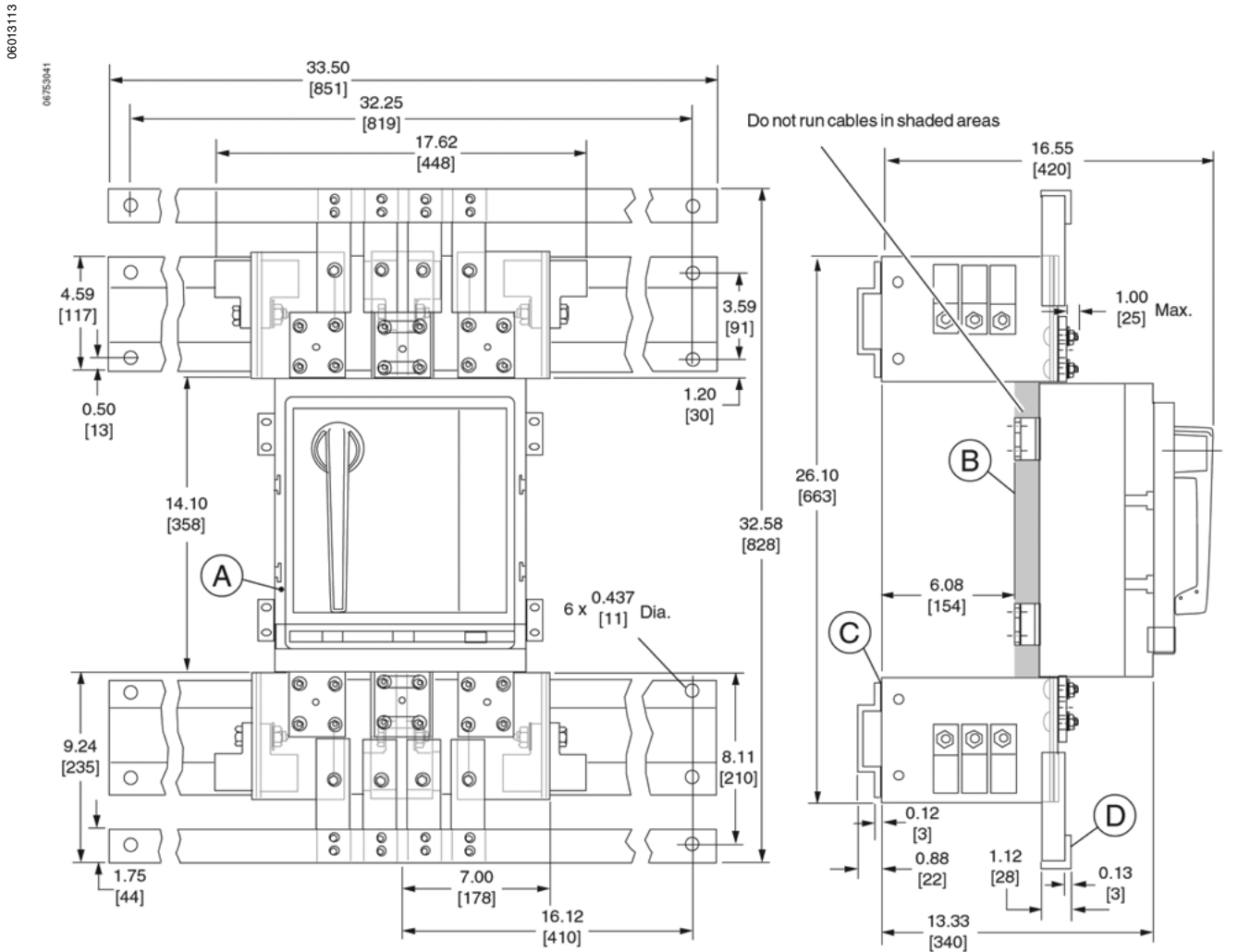

- A—Push-to-trip Button
- B—Mounting Plane
- C—Rear Support
- D—Front Support

Dimensions: In. [mm]

# Thermal-Magnetic / Magnetic Only Molded Case Circuit Breakers 2000 / 2500 Ampere Frame

Figure 21: PCF 2000 Ampere Frame

06013114

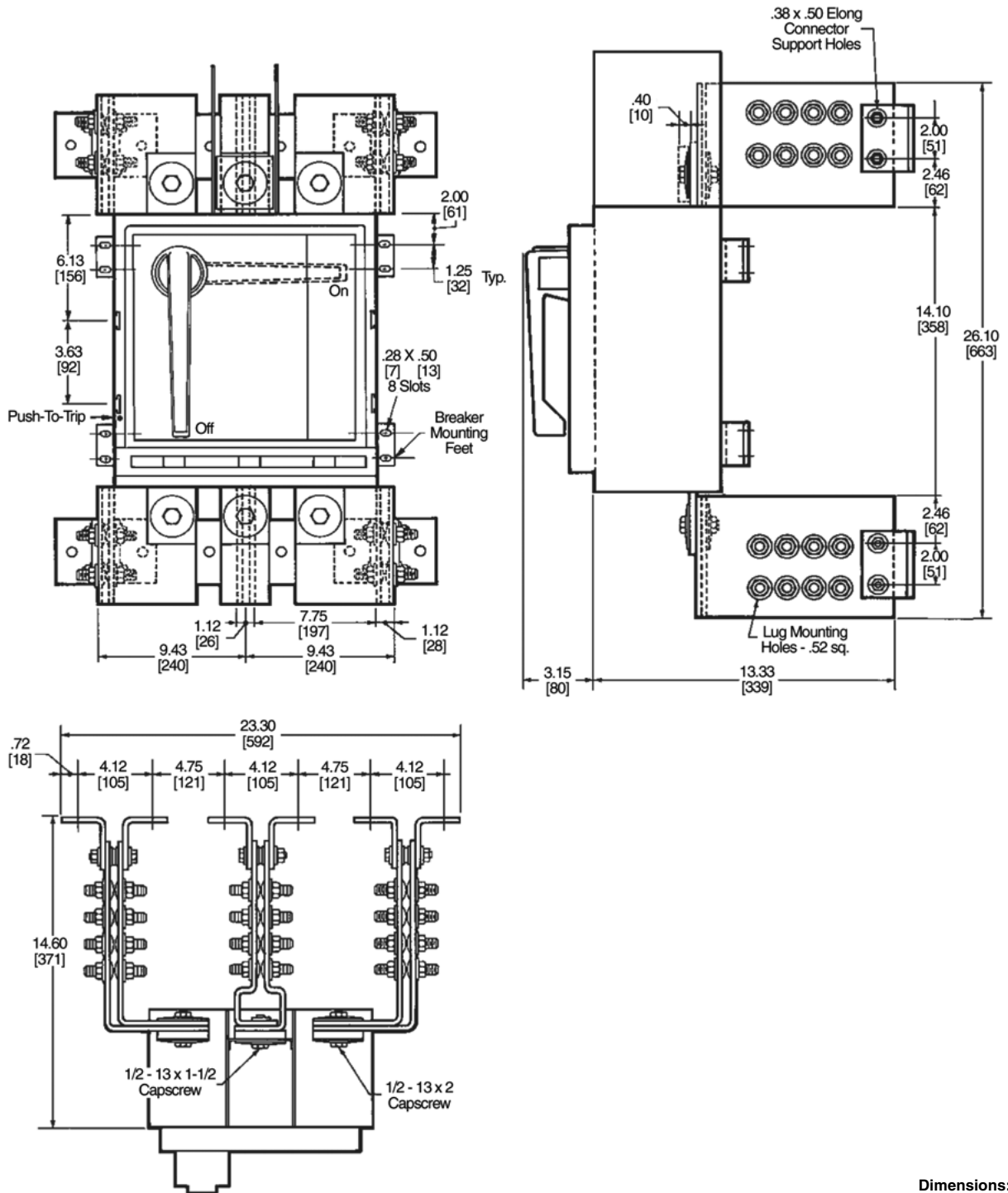

Dimensions: In.  
[mm]

# Thermal-Magnetic / Magnetic Only Molded Case Circuit Breakers 2000 / 2500 Ampere Frame

## Tripping Curves

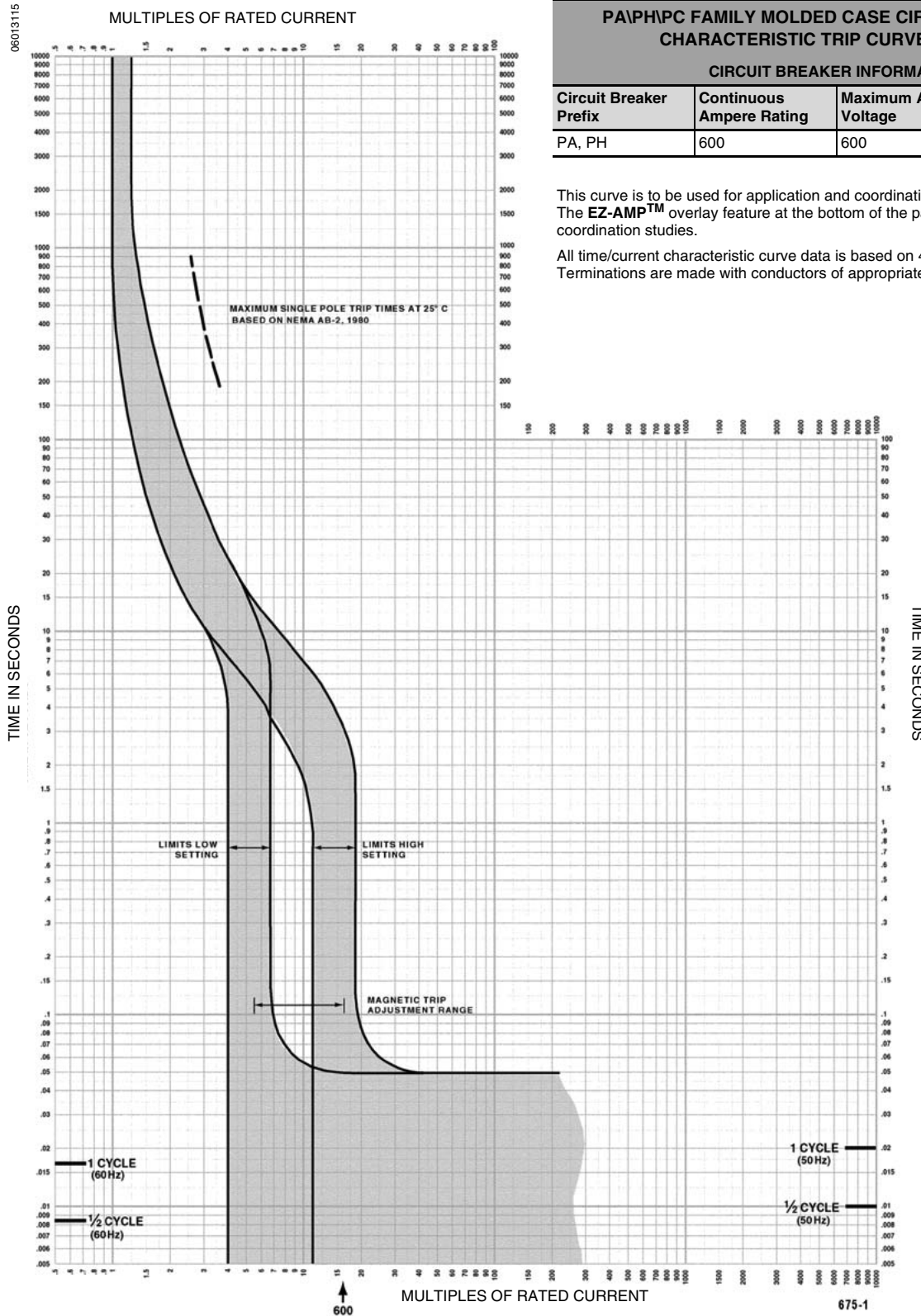

### PA/PH/PC FAMILY MOLDED CASE CIRCUIT BREAKERS CHARACTERISTIC TRIP CURVE NO. 675-1

#### CIRCUIT BREAKER INFORMATION

Circuit Breaker Prefix	Continuous Ampere Rating	Maximum AC Voltage	Number of Poles
PA, PH	600	600	2, 3

This curve is to be used for application and coordination purposes only. The **EZ-AMP™** overlay feature at the bottom of the page should be used during coordination studies.

All time/current characteristic curve data is based on 40°C ambient cold start. Terminations are made with conductors of appropriate length and ratings.

Tripping curves for coordination studies are available upon request.

Curve No. 0675TC8501  
Drawing No. 48095-675-01

# Thermal-Magnetic / Magnetic Only Molded Case Circuit Breakers 2000 / 2500 Ampere Frame

06013116

MULTIPLES OF RATED CURRENT

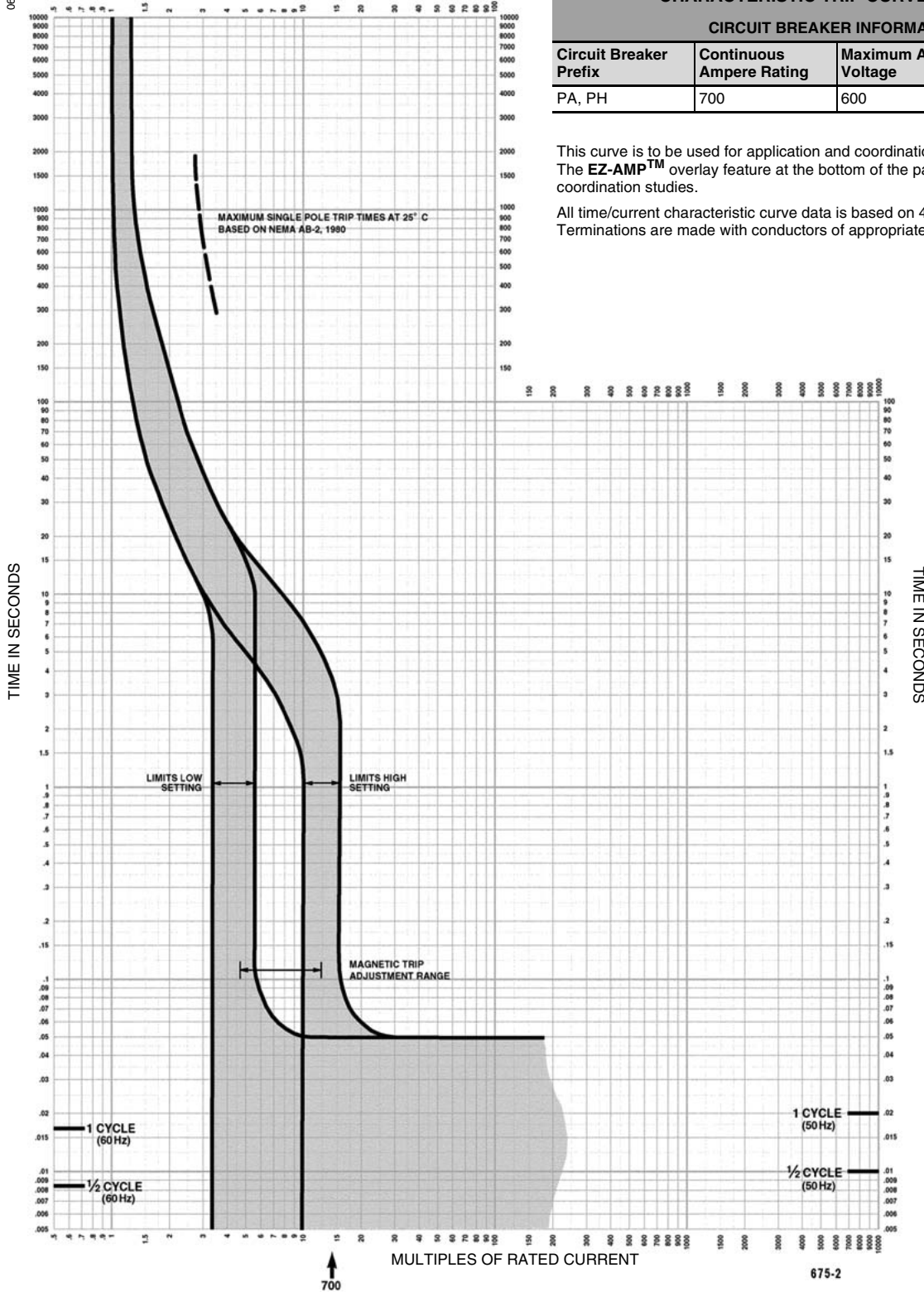

## PA/PH/PC FAMILY MOLDED CASE CIRCUIT BREAKERS CHARACTERISTIC TRIP CURVE NO. 675-2

### CIRCUIT BREAKER INFORMATION

Circuit Breaker Prefix	Continuous Ampere Rating	Maximum AC Voltage	Number of Poles
PA, PH	700	600	2, 3

This curve is to be used for application and coordination purposes only. The **EZ-AMP™** overlay feature at the bottom of the page should be used during coordination studies.

All time/current characteristic curve data is based on 40°C ambient cold start. Terminations are made with conductors of appropriate length and ratings.

Tripping curves for coordination studies are available upon request.

Curve No. 0675TC8502  
Drawing No. 48095-675-02

# Thermal-Magnetic / Magnetic Only Molded Case Circuit Breakers 2000 / 2500 Ampere Frame

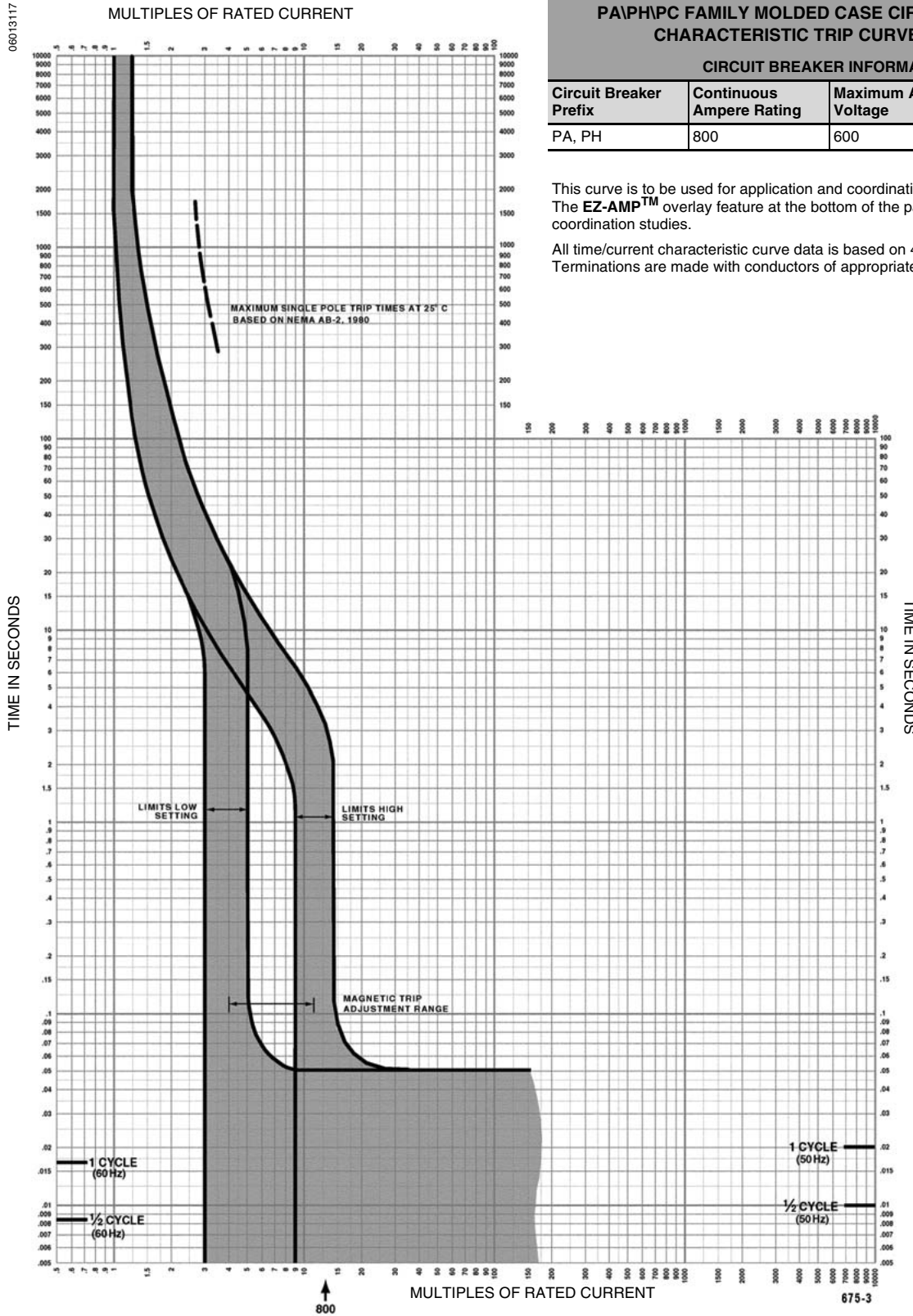

## PAIPHPC FAMILY MOLDED CASE CIRCUIT BREAKERS CHARACTERISTIC TRIP CURVE NO. 675-3

CIRCUIT BREAKER INFORMATION			
Circuit Breaker Prefix	Continuous Ampere Rating	Maximum AC Voltage	Number of Poles
PA, PH	800	600	2, 3

This curve is to be used for application and coordination purposes only. The **EZ-AMP™** overlay feature at the bottom of the page should be used during coordination studies.

All time/current characteristic curve data is based on 40°C ambient cold start. Terminations are made with conductors of appropriate length and ratings.

Tripping curves for coordination studies are available upon request.

Curve No. 0675TC8503  
Drawing No. 48095-675-03

# Thermal-Magnetic / Magnetic Only Molded Case Circuit Breakers 2000 / 2500 Ampere Frame

06013118

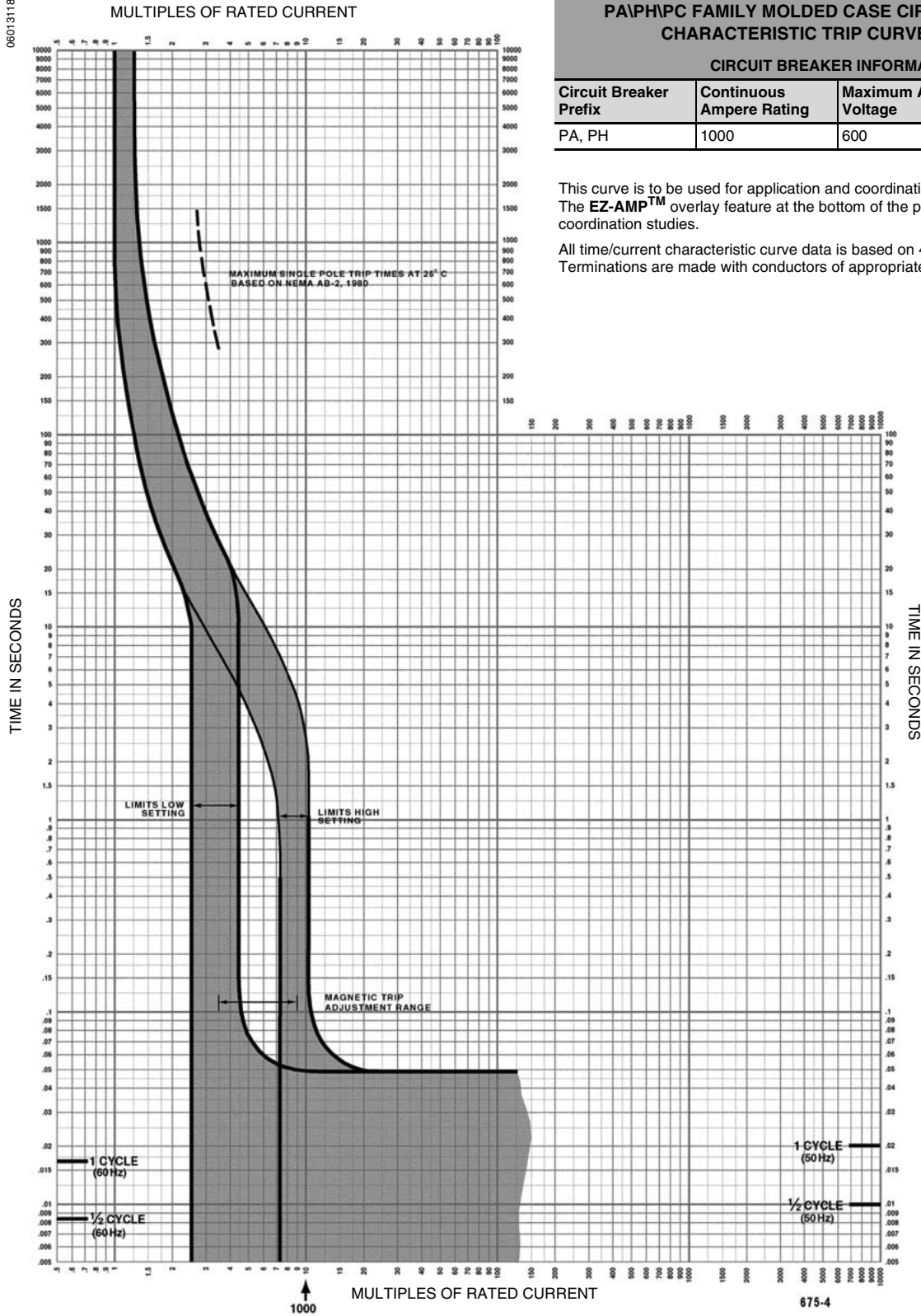

## PA/PH/PC FAMILY MOLDED CASE CIRCUIT BREAKERS CHARACTERISTIC TRIP CURVE NO. 675-4

### CIRCUIT BREAKER INFORMATION

Circuit Breaker Prefix	Continuous Ampere Rating	Maximum AC Voltage	Number of Poles
PA, PH	1000	600	2, 3

This curve is to be used for application and coordination purposes only. The **EZ-AMP™** overlay feature at the bottom of the page should be used during coordination studies.

All time/current characteristic curve data is based on 40°C ambient cold start. Terminations are made with conductors of appropriate length and ratings.

Tripping curves for coordination studies are available upon request.

Curve No. 0675TC8504  
Drawing No. 48095-675-04

# Thermal-Magnetic / Magnetic Only Molded Case Circuit Breakers 2000 / 2500 Ampere Frame

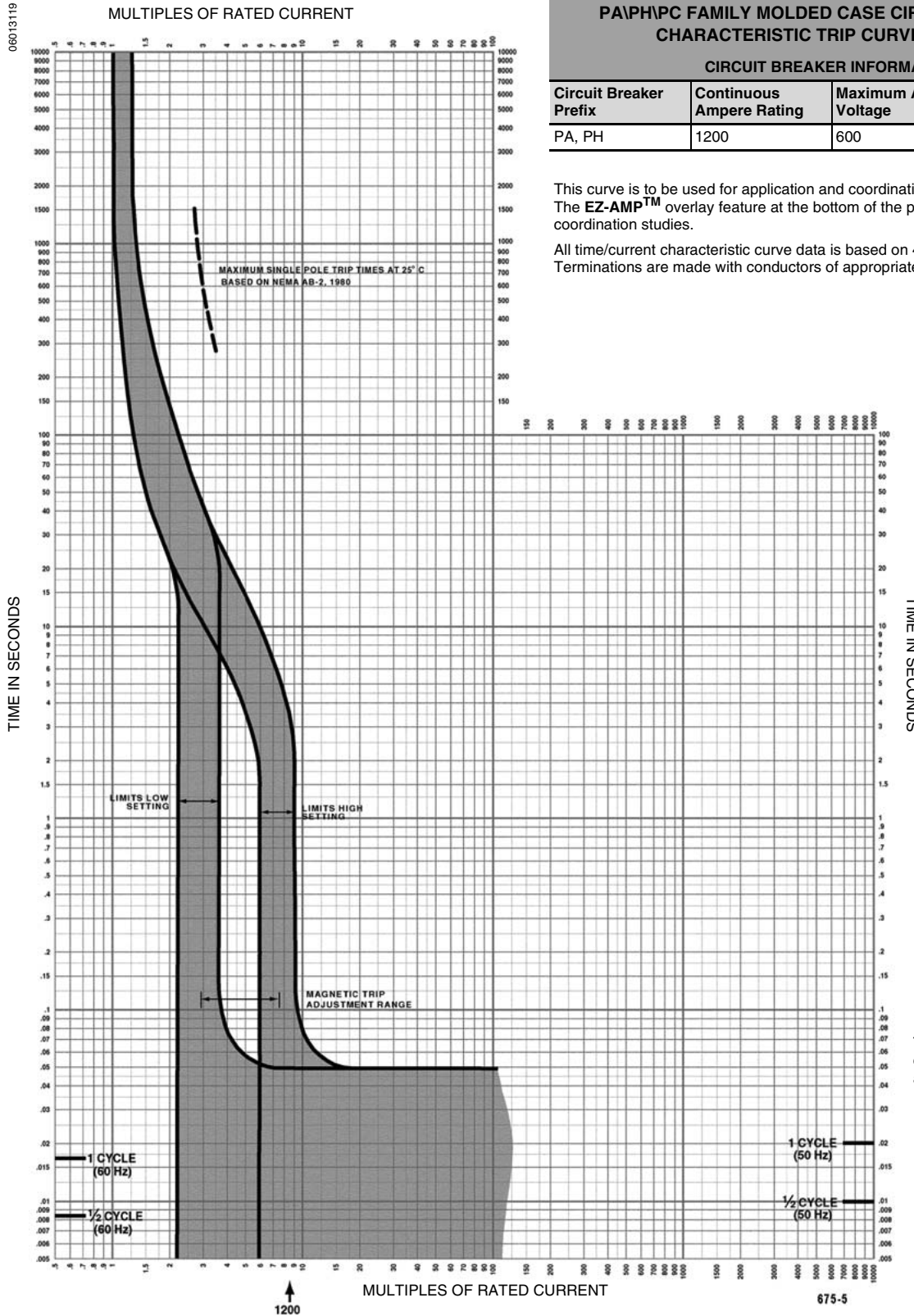

## PA/PH/PC FAMILY MOLDED CASE CIRCUIT BREAKERS CHARACTERISTIC TRIP CURVE NO. 675-5

CIRCUIT BREAKER INFORMATION			
Circuit Breaker Prefix	Continuous Ampere Rating	Maximum AC Voltage	Number of Poles
PA, PH	1200	600	2, 3

This curve is to be used for application and coordination purposes only. The **EZ-AMP™** overlay feature at the bottom of the page should be used during coordination studies.

All time/current characteristic curve data is based on 40°C ambient cold start. Terminations are made with conductors of appropriate length and ratings.

Tripping curves for coordination studies are available upon request.

Curve No. 0675TC8505  
Drawing No. 48095-675-05

# Thermal-Magnetic / Magnetic Only Molded Case Circuit Breakers 2000 / 2500 Ampere Frame

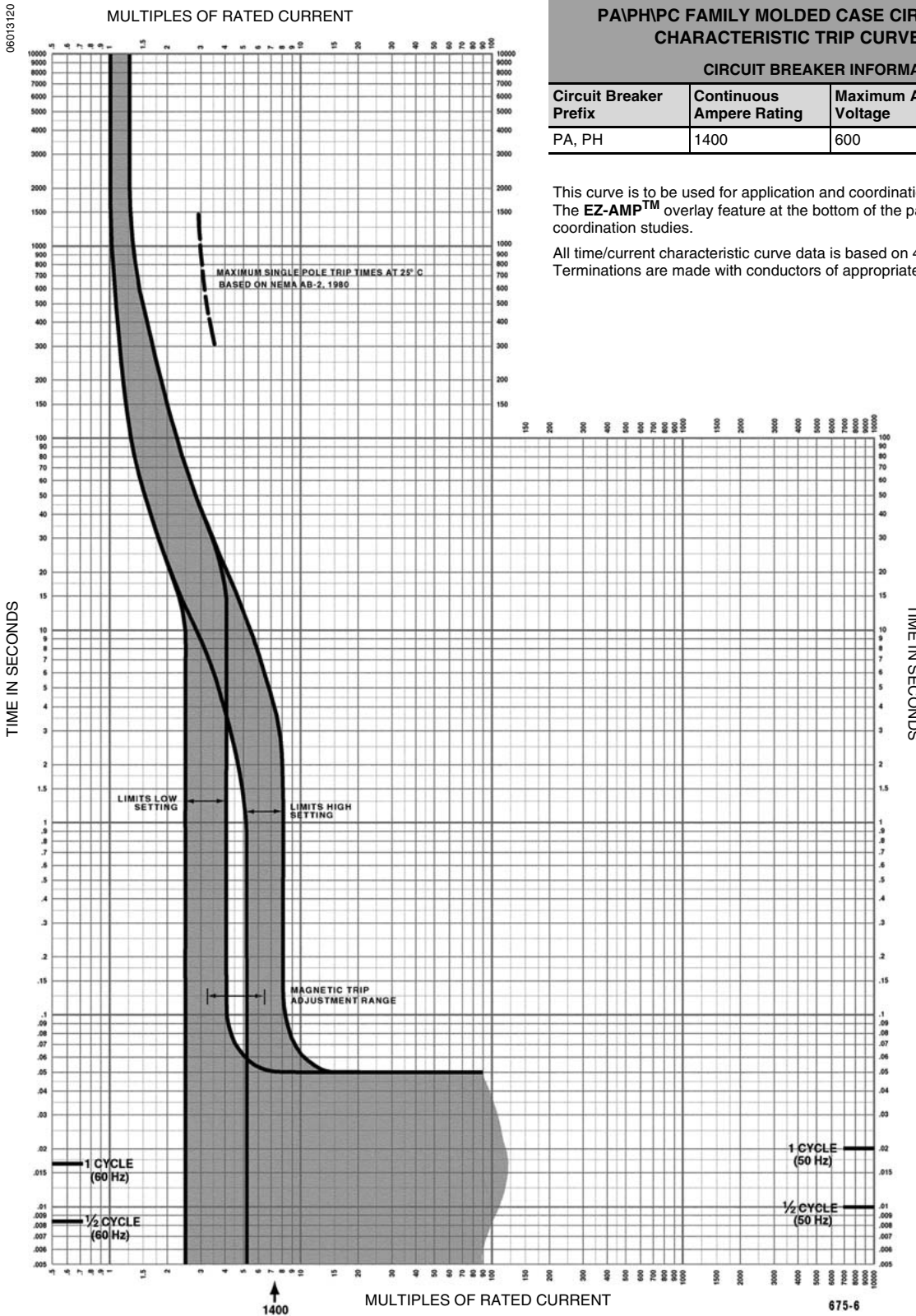

## PA/PH/PC FAMILY MOLDED CASE CIRCUIT BREAKERS CHARACTERISTIC TRIP CURVE NO. 675-6

CIRCUIT BREAKER INFORMATION			
Circuit Breaker Prefix	Continuous Ampere Rating	Maximum AC Voltage	Number of Poles
PA, PH	1400	600	2, 3

This curve is to be used for application and coordination purposes only. The **EZ-AMP™** overlay feature at the bottom of the page should be used during coordination studies.

All time/current characteristic curve data is based on 40°C ambient cold start. Terminations are made with conductors of appropriate length and ratings.

Tripping curves for coordination studies are available upon request.

Curve No. 0675TC8506  
Drawing No. 48095-675-06

# Thermal-Magnetic / Magnetic Only Molded Case Circuit Breakers 2000 / 2500 Ampere Frame

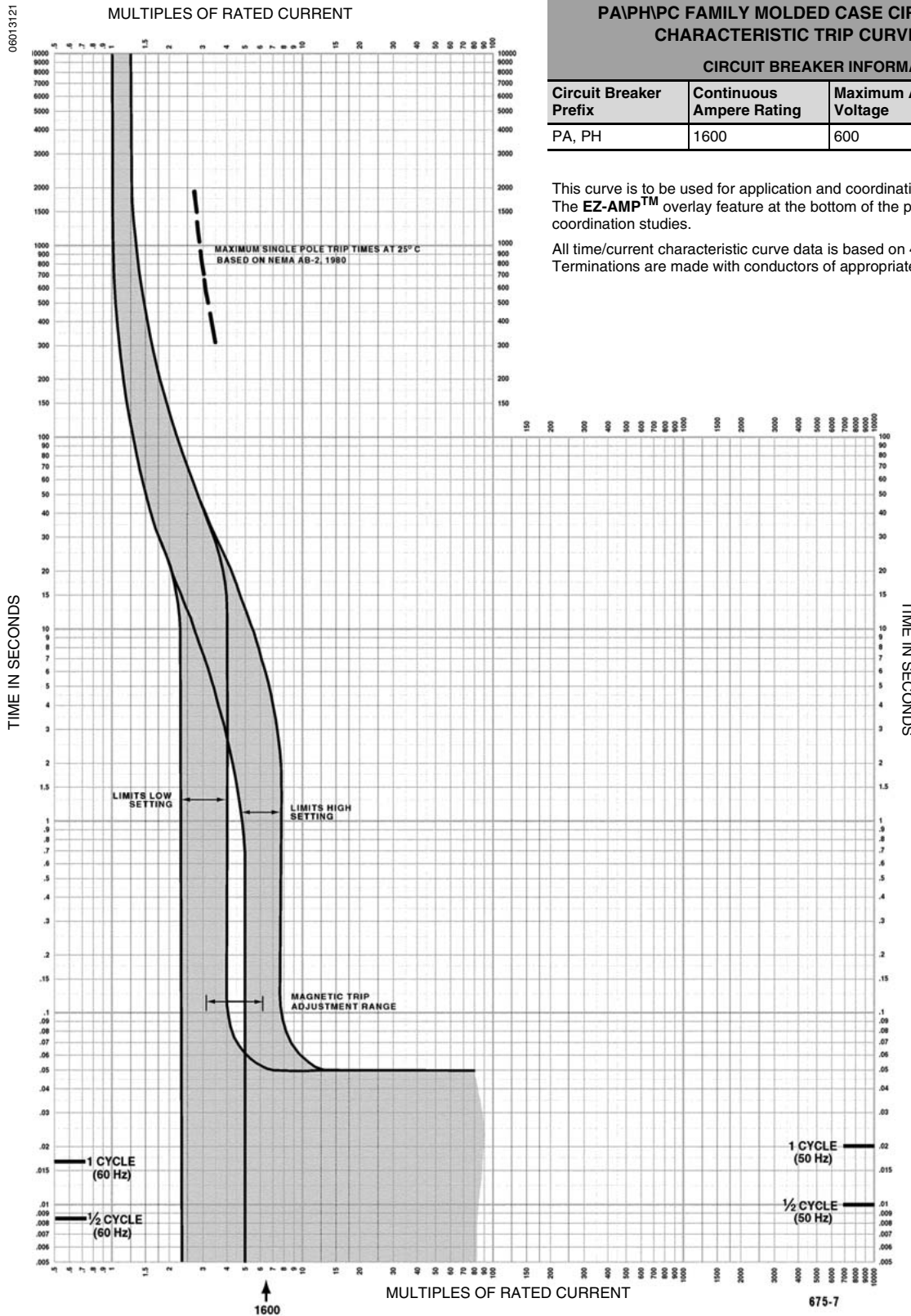

## PA/PH/PC FAMILY MOLDED CASE CIRCUIT BREAKERS CHARACTERISTIC TRIP CURVE NO. 675-7

CIRCUIT BREAKER INFORMATION			
Circuit Breaker Prefix	Continuous Ampere Rating	Maximum AC Voltage	Number of Poles
PA, PH	1600	600	2, 3

This curve is to be used for application and coordination purposes only. The **EZ-AMP™** overlay feature at the bottom of the page should be used during coordination studies.

All time/current characteristic curve data is based on 40°C ambient cold start. Terminations are made with conductors of appropriate length and ratings.

Tripping curves for coordination studies are available upon request.

Curve No. 0675TC8507  
Drawing No. 48095-675-07

# Thermal-Magnetic / Magnetic Only Molded Case Circuit Breakers 2000 / 2500 Ampere Frame

06013122

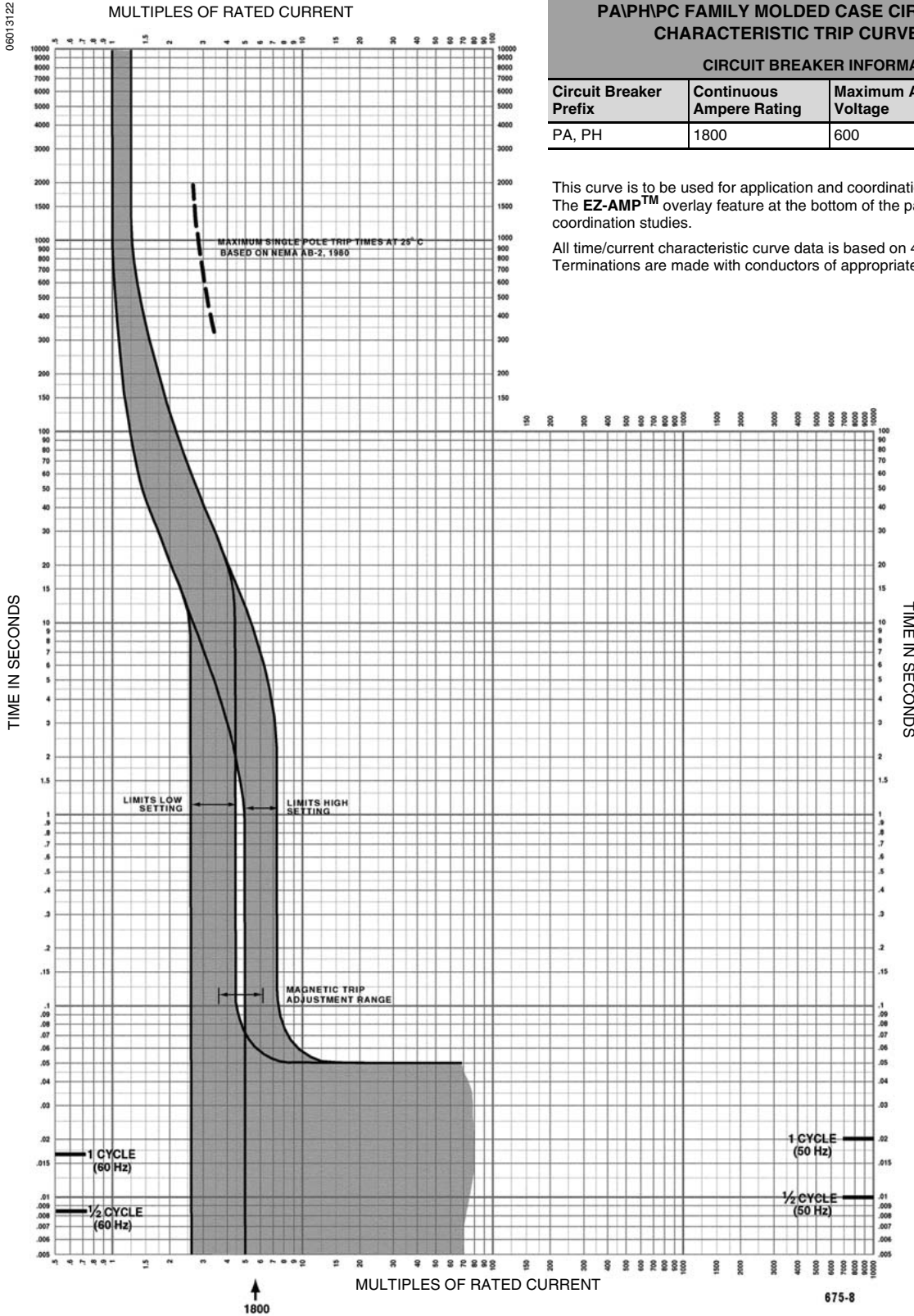

## PAIPHPC FAMILY MOLDED CASE CIRCUIT BREAKERS CHARACTERISTIC TRIP CURVE NO. 675-8

CIRCUIT BREAKER INFORMATION			
Circuit Breaker Prefix	Continuous Ampere Rating	Maximum AC Voltage	Number of Poles
PA, PH	1800	600	2, 3

This curve is to be used for application and coordination purposes only. The **EZ-AMP™** overlay feature at the bottom of the page should be used during coordination studies.

All time/current characteristic curve data is based on 40°C ambient cold start. Terminations are made with conductors of appropriate length and ratings.

Tripping curves for coordination studies are available upon request.

Curve No. 0675TC8508  
Drawing No. 48095-675-08

# Thermal-Magnetic / Magnetic Only Molded Case Circuit Breakers 2000 / 2500 Ampere Frame

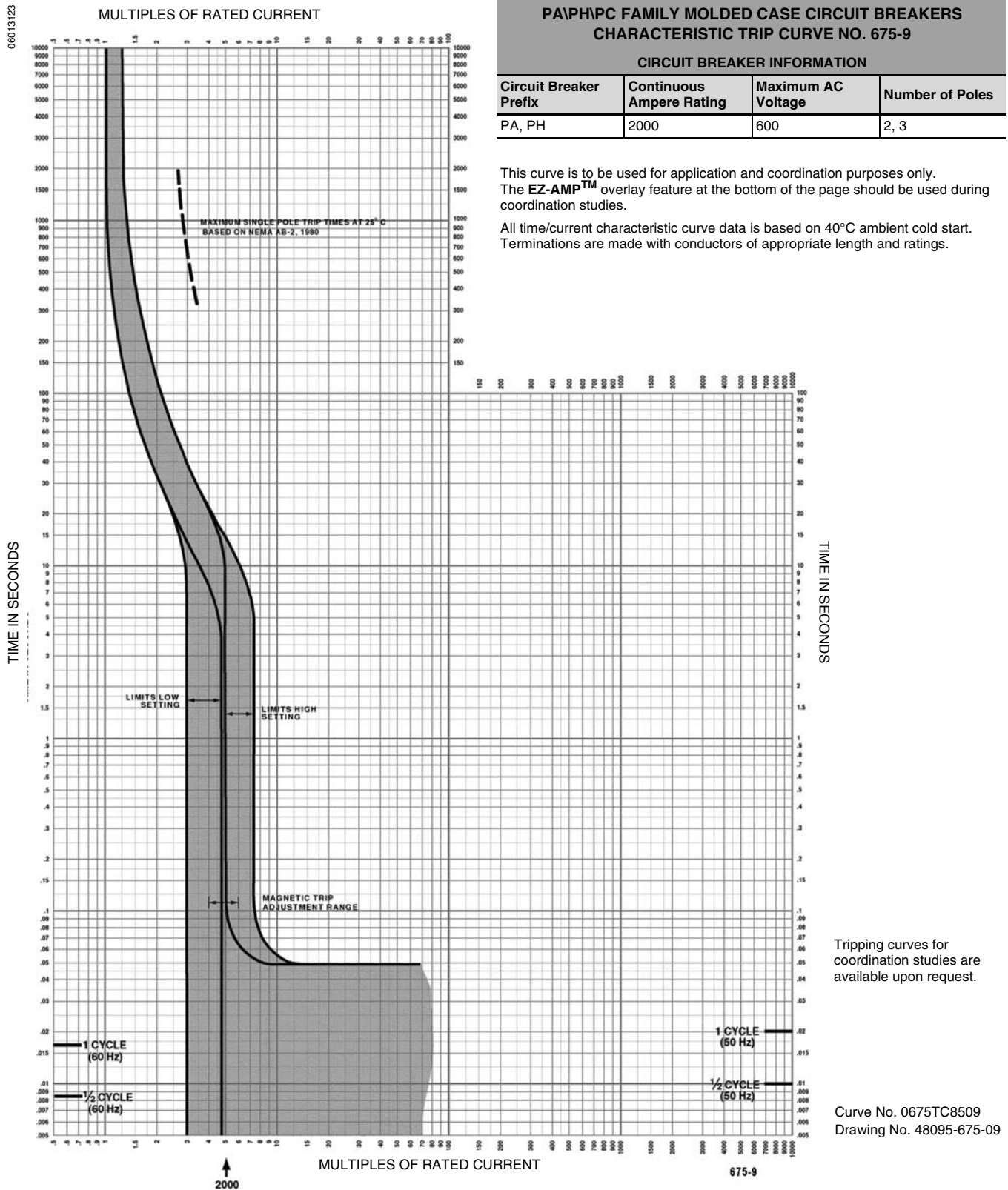

Tripping curves for coordination studies are available upon request.

Curve No. 0675TC8509  
Drawing No. 48095-675-09

# Thermal-Magnetic / Magnetic Only Molded Case Circuit Breakers 2000 / 2500 Ampere Frame

06013124

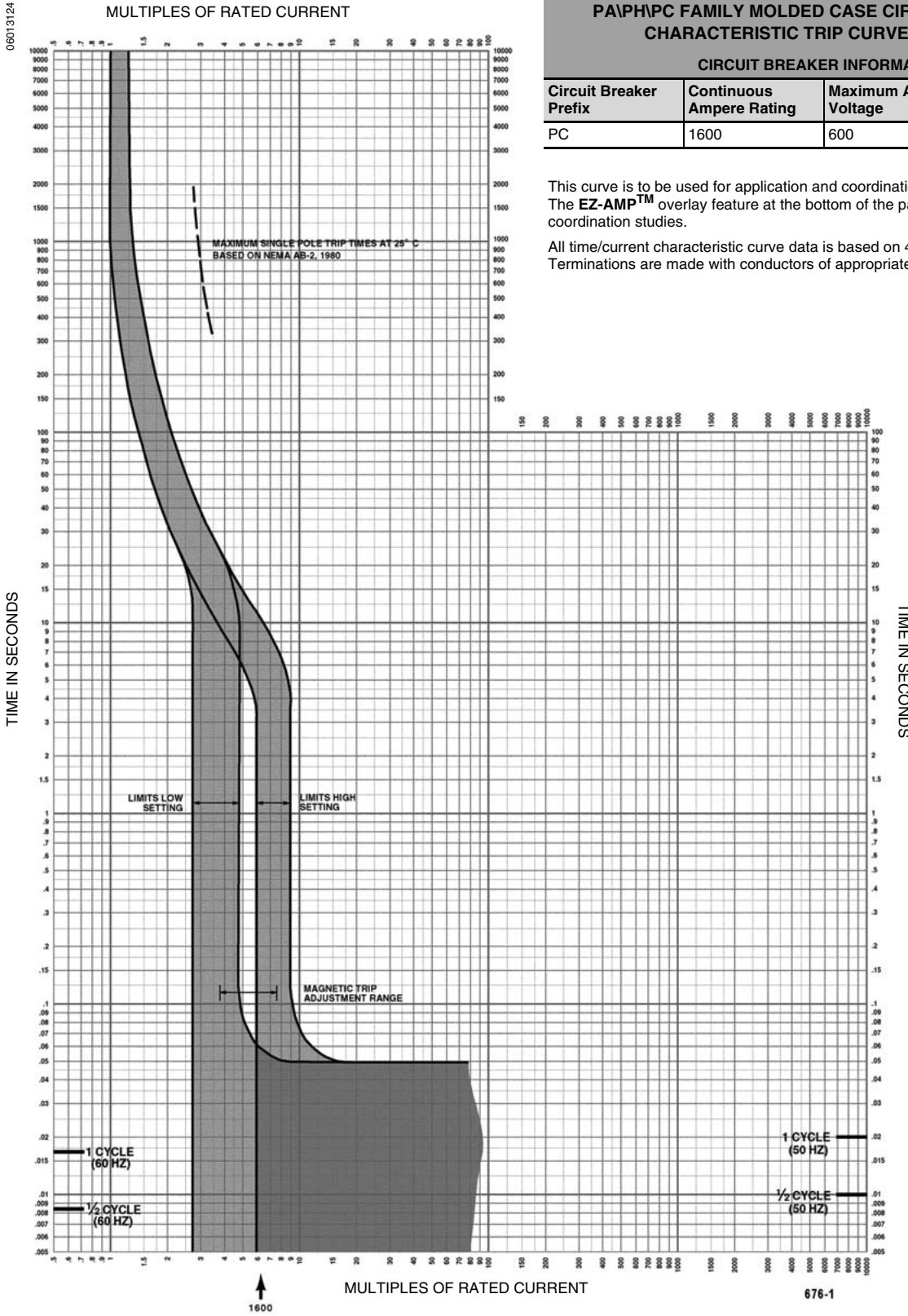

## PAIPH/PC FAMILY MOLDED CASE CIRCUIT BREAKERS CHARACTERISTIC TRIP CURVE NO. 676-01

CIRCUIT BREAKER INFORMATION			
Circuit Breaker Prefix	Continuous Ampere Rating	Maximum AC Voltage	Number of Poles
PC	1600	600	2, 3

This curve is to be used for application and coordination purposes only. The **EZ-AMP™** overlay feature at the bottom of the page should be used during coordination studies.

All time/current characteristic curve data is based on 40°C ambient cold start. Terminations are made with conductors of appropriate length and ratings.

Tripping curves for coordination studies are available upon request.

Curve No. 0676TC8501  
Drawing No. 48095-676-01

# Thermal-Magnetic / Magnetic Only Molded Case Circuit Breakers 2000 / 2500 Ampere Frame

06013125

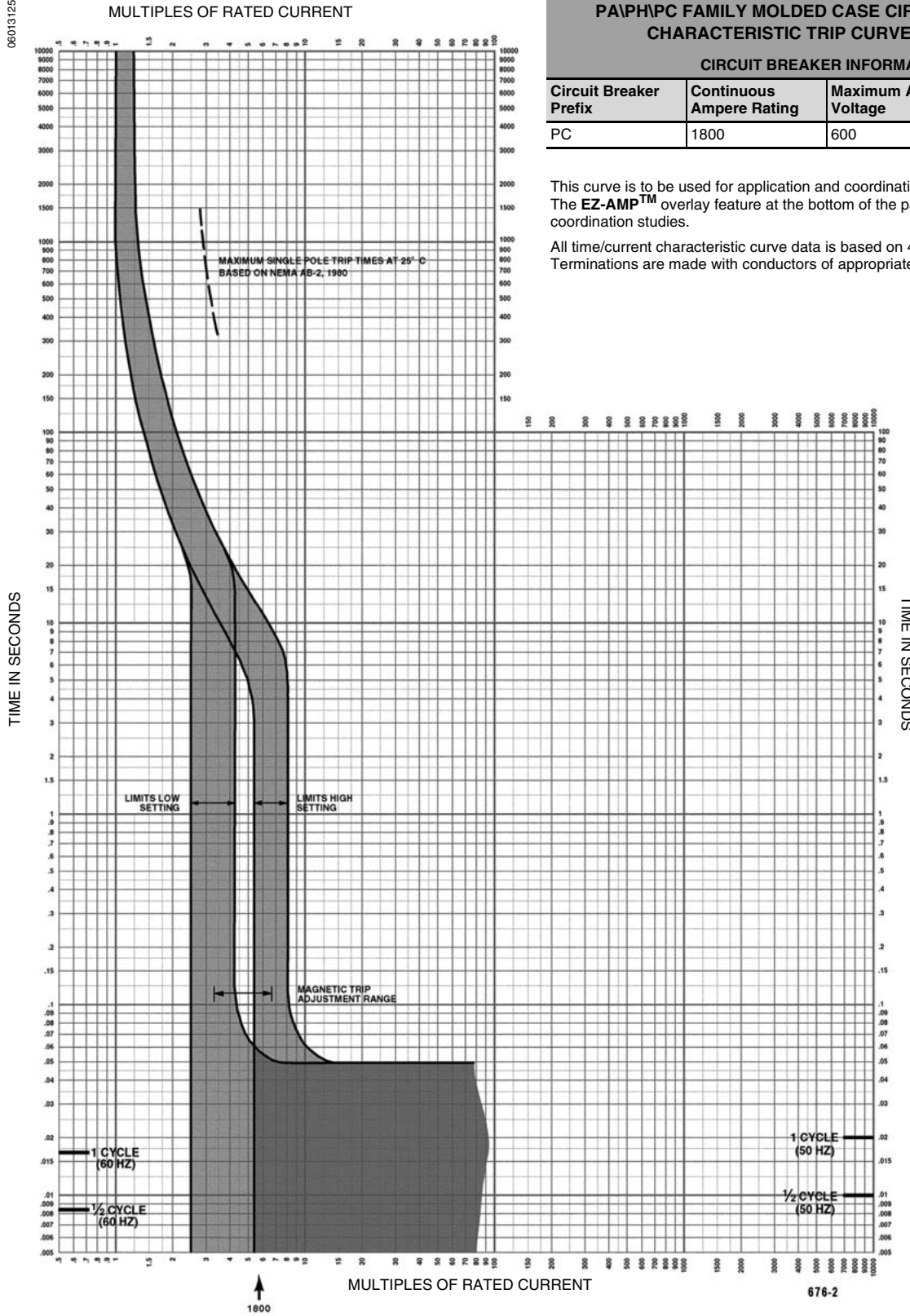

## PAIPH/PC FAMILY MOLDED CASE CIRCUIT BREAKERS CHARACTERISTIC TRIP CURVE NO. 676-02

### CIRCUIT BREAKER INFORMATION

Circuit Breaker Prefix	Continuous Ampere Rating	Maximum AC Voltage	Number of Poles
PC	1800	600	2, 3

This curve is to be used for application and coordination purposes only. The **EZ-AMP™** overlay feature at the bottom of the page should be used during coordination studies.

All time/current characteristic curve data is based on 40°C ambient cold start. Terminations are made with conductors of appropriate length and ratings.

Tripping curves for coordination studies are available upon request.

Curve No. 0676TC8502  
Drawing No. 48095-676-02

# Thermal-Magnetic / Magnetic Only Molded Case Circuit Breakers 2000 / 2500 Ampere Frame

06013126

## PAIPHPC FAMILY MOLDED CASE CIRCUIT BREAKERS CHARACTERISTIC TRIP CURVE NO. 676-03

CIRCUIT BREAKER INFORMATION			
Circuit Breaker Prefix	Continuous Ampere Rating	Maximum AC Voltage	Number of Poles
PC	2000	600	2, 3

This curve is to be used for application and coordination purposes only. The **EZ-AMP™** overlay feature at the bottom of the page should be used during coordination studies.

All time/current characteristic curve data is based on 40°C ambient cold start. Terminations are made with conductors of appropriate length and ratings.

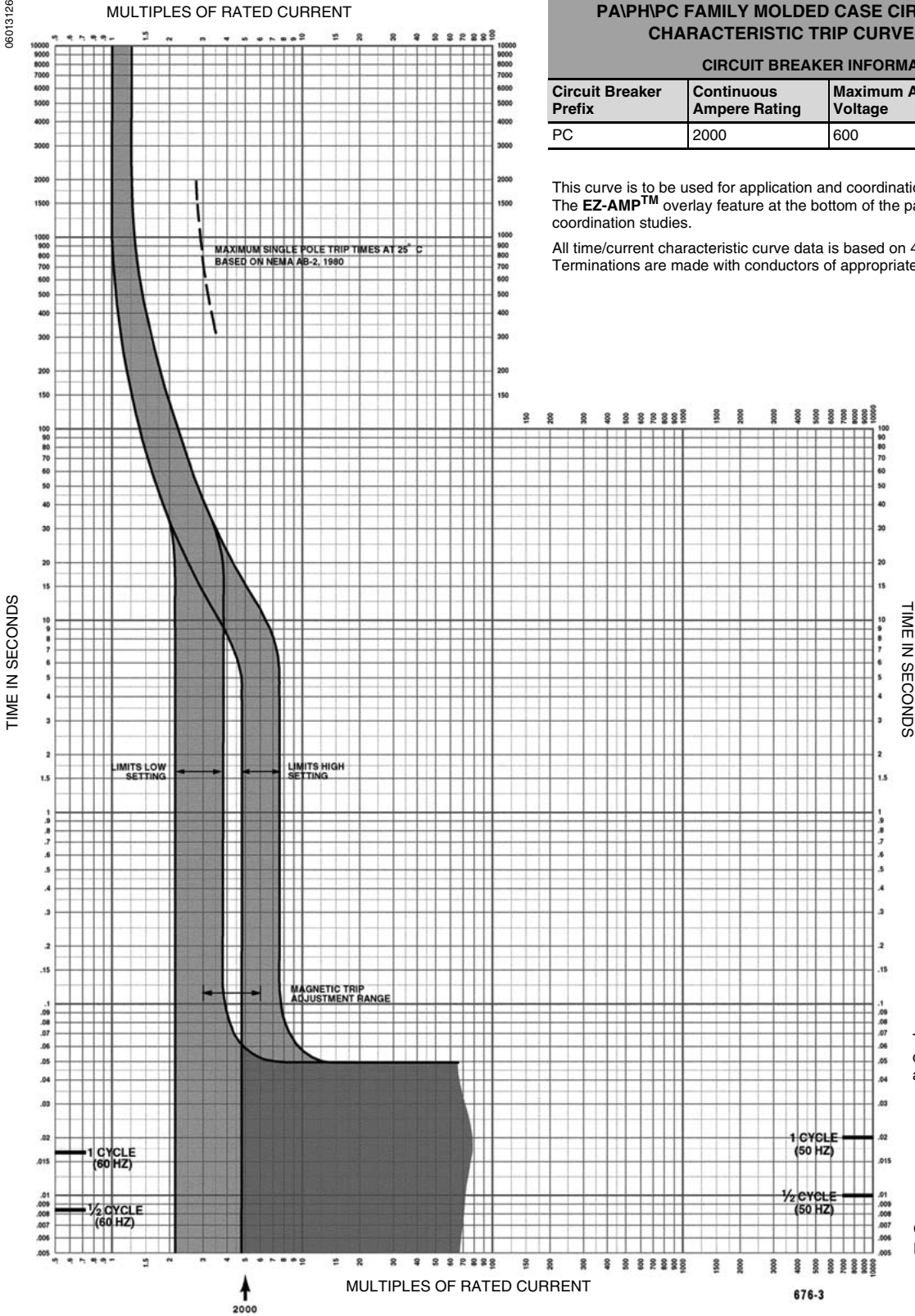

Tripping curves for coordination studies are available upon request.

Curve No. 0676TC8503  
Drawing No. 48095-676-03

# Thermal-Magnetic / Magnetic Only Molded Case Circuit Breakers 2000 / 2500 Ampere Frame

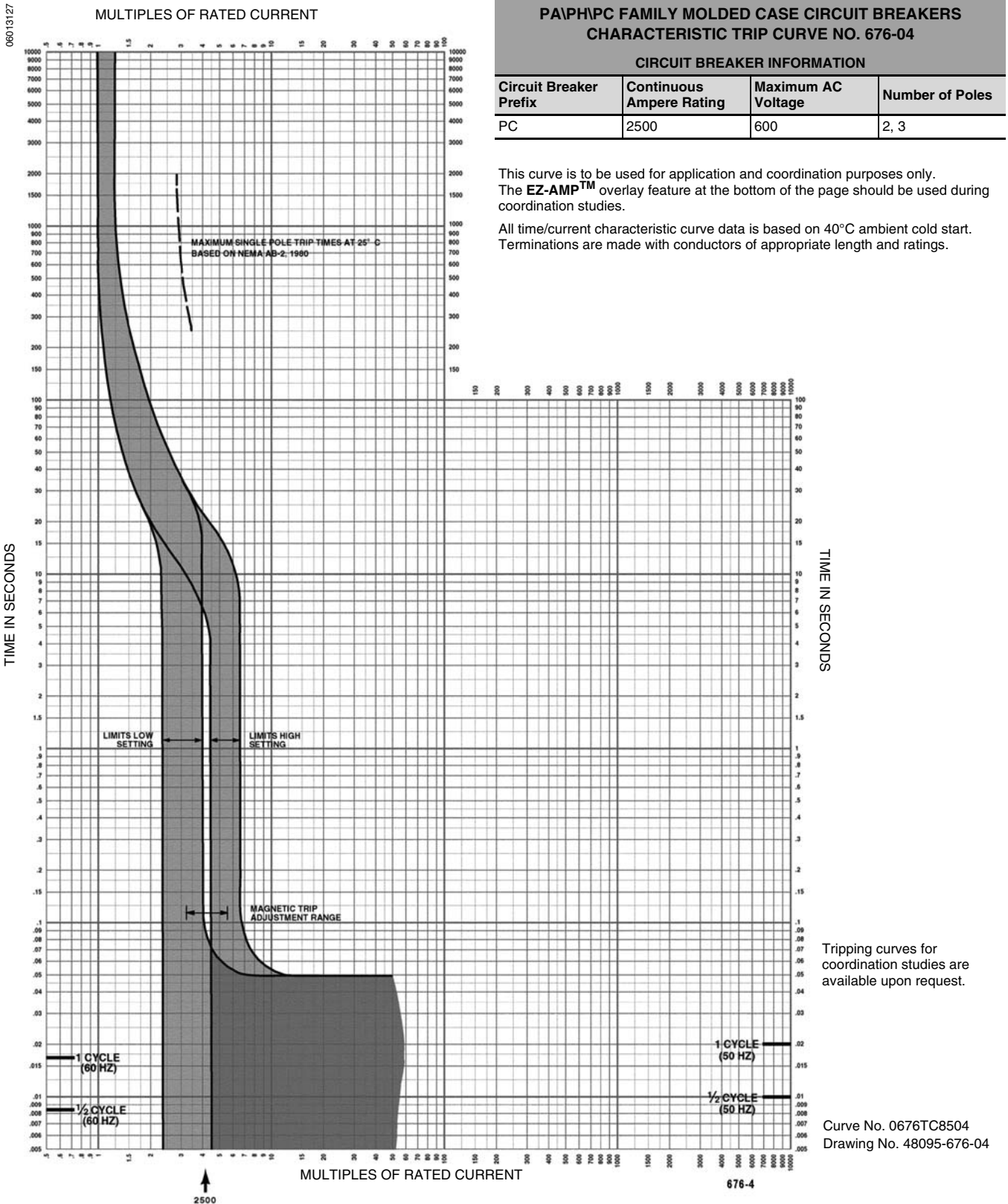

# Thermal-Magnetic / Magnetic Only Molded Case Circuit Breakers Magnetic Only Molded Case Circuit Breakers

## MAGNETIC ONLY MOLDED CASE CIRCUIT BREAKERS

This section provides specific information on Square D® magnetic only molded case circuit breakers. For more information, see the Introduction in this catalog.

### Description

**Table 45: Description of Magnetic Only Circuit Breakers**

Circuit Breaker	Description
Mag-Gard®	3–1200 ampere, 600 Vac, 50/60 Hz, 3-pole, instantaneous trip

### Characteristics

Mag-Gard magnetic only instantaneous trip circuit breakers are similar in construction to thermal-magnetic circuit breakers. Mag-Gard circuit breakers were tested per UL Standard 485, in combination with Square D starters at the following available fault currents:

**Table 46: Combination Starters - NEMA Application Data**

Mag-Gard Motor Circuit Protector Type			
NEMA Type	Voltage	Enclosure	Available Amperes RMS Symmetrical
0 & 1	0-480	Standard★ & Oversize	22,000
0 & 1	481-600	Standard★ & Oversize	10,000
0-2 with Current Limiting Module	600	Oversize	100,000
0-3 with Current Limiting Module	600	Standard★	100,000
0-3	600	NEMA 7 & 9	5,000
2	600	Oversize	22,000
2-6	600	Standard★	22,000
4 with Current Limiting Panel	600	Standard★	100,000
4 & 5	600	NEMA 7 & 9	10,000
7	0-480	Standard★	30,000
7	481-600	Standard★	22,000

★ Standard enclosure includes non-oversize NEMA Types 1, 4 & 4X Stainless, 4X Polyester, and 12.

### Ampere Rating

The Mag-Gard ampere rating is its continuous current carrying capacity. Continuous currents larger than the ampere rating can damage the circuit breaker. Mag-Gard circuit breakers do not contain thermal trip elements.

The current range over which the instantaneous magnetic trip point may be adjusted is the adjustable trip range amperes.

### Magnetic Adjustment

FA through NA frame Mag-Gard circuit breakers have an adjustable instantaneous magnetic trip.

# Thermal-Magnetic / Magnetic Only Molded Case Circuit Breakers

## Magnetic Only Molded Case Circuit Breakers

### Selection Data

Table 47: Magnetic Only Circuit Breakers

Ampere Rating	Adjustable* Trip Range Amperes	Suffix	3-Pole	
			Catalog Number	
<b>3-1200 Amperes, 600 Vac, 50/60 Hz<sup>▲</sup></b>				
FAL <sup>■</sup>	3	8-28	—	FAL3600311M
	7	18-70	—	FAL3600712M
	15	50-180	—	FAL3601513M
	30	50-180	—	FAL3603013M
	30	100-350	—	FAL3603015M
	50	75-260	—	FAL3605014M
	50	150-580	—	FAL3605016M
	100	150-580	—	FAL3610016M
	100	300-1100	—	FAL3610018M
GJL	3	9-33	—	GJL36003M01
	7	21-77	—	GJL36007M02
	15	45-165	—	GJL36015M03
	30	90-330	—	GJL36030M04
	50	150-550	—	GJL36050M05
	75	225-825	—	GJL36075M06
KAL	150	750-1500	—	KAL3615026M
	250	400-800	—	KAL3625021M
		500-1000	—	KAL3625022M
		625-1250	—	KAL3625025M
		750-1500	—	KAL3625026M
		875-1750	—	KAL3625029M
		1000-2000	—	KAL3625030M
		1125-2250	—	KAL3625031M
1250-2500	—	KAL3625032M		
LAL	400	500-1000	—	LAL3640022M
		750-1600	—	LAL3640028M
		1000-2000	—	LAL3640030M
		1125-2250	—	LAL3640031M
		1250-2500	—	LAL3640032M
		1500-3000	—	LAL3640033M
		1750-3500	—	LAL3640035M
	2000-4000	—	LAL3640036M	
MAL <sup>★★</sup>	600		—	MAL36600
	800		—	MAL36800
	1000		—	MAL361000
		625-1250	25M	
		750-1500	26M	
		1000-2000	30M	
		1500-3000	33M	
		2000-4000	36M	
		2500-5000	40M	
		3000-6000	42M	
		3500-7000	44M	
	4000-8000	45M		
	4500-8600	46M		
	5000-9000	47M		

Continued on next page

## Thermal-Magnetic / Magnetic Only Molded Case Circuit Breakers Magnetic Only Molded Case Circuit Breakers

**Table 47: Magnetic Only Circuit Breakers (continued)**

Ampere Rating	Adjustable <sup>★</sup> Trip Range Amperes	Suffix	3-Pole
			Catalog Number
<b>3-1200 Amperes, 600 Vac, 50/60 Hz<sup>▲</sup></b>			
NAL            1200	4000-8000	—	NAL36120045M
	4500-9000	—	NAL36120046M
	5000-10000	—	NAL36120047M

★ UL magnetic trip setting tolerances are ±20% from the nominal values shown.

▲ 250 Vdc ratings are available except on NA. Consult factory for trip range. No UL component recognition.

■ FAL frame has line and load restriction and cannot be reverse connected.

★★ Each ampere rating can be ordered with any designated trip range for the frame by adding the proper suffix to catalog numbers.

### Adjustable Instantaneous-trip Circuit Breakers for Single Motor Circuit Protection

Adjustable instantaneous-trip circuit breakers are intended for use in combination with motor starters with overload relays for the protection of motor circuits from short circuits. Other specific applications include rectifiers and resistance welders. These circuit breakers contain a magnetic trip element in each pole with the trip point adjustable from the front. Interrupting ratings are determined by testing the instantaneous-trip circuit breakers in combination with a contactor and overload relay.

1. This selection table is suitable for motors, other than NEMA Design E, with locked-rotor indicating code letters per NEC Table 430.7 (b) as follows:

Horsepower	Motor Code Letters
1/2 or less	A-L
3/4 to 1-1/2	A-K
2 to 3	A-J
5 to 25	A-H
30 to 125	A-G
150 or more	A-F

For other motors order a special thermal-magnetic circuit breaker with magnetic trip settings for the specific motor— specify motor horsepower, voltage, frequency, full-load current and code letter or locked rotor current.

2. Determine motor hp rating from the motor nameplate.
3. Refer to the table at right and select an instantaneous- trip circuit breaker with an Ampere rating recommended for the hp and voltage involved.
4. Select an adjustable trip setting of at least 800%, not to exceed 1300%, of the motor full-load amperes (FLA) for other than Design E motors. For Design E motors, select an adjustable trip setting of at least 1100% not to exceed 1700% of FLA.
5. The NEC 1300% maximum setting may be inadequate for instantaneous-trip circuit breakers to withstand current surges typical of the magnetization current of autotransformer type reduced voltage starters, or open transition wye-delta starters during transfer from "start" to "run," constant hp multi-speed motors, and motors labeled "high efficiency." Select thermal-magnetic circuit breakers from page 6-35 for those applications.
6. Part-winding motors, per NEC 430.3, should have two circuit breakers selected from the above at not more than one half the allowable trip setting for the horsepower rating. The two circuit breakers should operate simultaneously as a disconnecting means per NEC 430.103.

# Thermal-Magnetic / Magnetic Only Molded Case Circuit Breakers

## Magnetic Only Molded Case Circuit Breakers

**Table 48: Adjustable Instantaneous Trip Circuit Breakers for Single Motor Circuit Protection**

NOTE: Based on NEC 430.52 and NEC Table 430.150.

Hp Ratings of Induction Type Squirrel-cage and Wound Rotor Motors				★Full Load Amperes	Mag-Gard® Circuit Breaker Catalog No.	★★Magnetic Trip Settings		GJL Family Mag-Gard Circuit Breaker Catalog No.	★★Magnetic Trip Settings	
Three-Phase 60 Hz ac						MIN	MAX		MIN	MAX
200 Volts	230 Volts	460 Volts	575 Volts							
			1/2	0.8	FAL3600311M★	1000%	3500%	GJL36003M01▲	1100%	4100%
		1/2		1	FAL3600311M★	800%	2800%	GJL36003M01▲	900%	3300%
			3/4	1.1	FAL3600311M	700%	2500%	GJL36003M01▲	800%	3000%
		3/4	1	1.4	FAL3600311M	600%	2000%	GJL36003M01	600%	2400%
		1		1.8	FAL3600311M	400%	1600%	GJL36003M01	500%	1800%
	1/2			2	FAL3600311M	400%	1400%	GJL36003M01	500%	1700%
			1-1/2	2.1	FAL3600311M	400%	1300%	GJL36003M01	400%	1600%
1/2				2.3	FAL3600311M■	300%	1200%	GJL36003M01	400%	1400%
		1-1/2		2.6	FAL3600712M	700%	2700%	GJL36003M01	300%	1300%
			2	2.7	FAL3600712M	700%	2600%	GJL36003M01■	300%	1200%
	3/4			2.8	FAL3600712M	600%	2500%	GJL36003M01■	300%	1200%
3/4				3.2	FAL3600712M	600%	2200%	GJL36007M02	700%	2400%
		2		3.4	FAL3600712M	500%	2100%	GJL36007M02	600%	2300%
	1			3.6	FAL3600712M	500%	1900%	GJL36007M02	600%	2100%
			3	3.9	FAL3600712M	500%	1800%	GJL36007M02	500%	2000%
1				4.1	FAL3600712M	400%	1700%	GJL36007M02	500%	1900%
		3		4.8	FAL3600712M	400%	1500%	GJL36007M02	400%	1600%
	1-1/2			5.2	FAL3600712M	300%	1300%	GJL36007M02	400%	1500%
1-1/2				6	FAL3600712M■	300%	1200%	GJL36007M02	400%	1300%
			5	6.1	FAL3600712M■	300%	1100%	GJL36015M03	700%	2700%
	2			6.8	FAL3601513M	700%	2600%	GJL36015M03	700%	2400%
		5		7.6	FAL3601513M	700%	2400%	GJL36015M03	600%	2200%
2				7.8	FAL3601513M	600%	2300%	GJL36015M03	600%	2100%
			7-1/2	9	FAL3601513M	600%	2000%	GJL36015M03	500%	1800%
	3			9.6	FAL3601513M	500%	1900%	GJL36015M03	500%	1700%
3		7-1/2	10	11	FAL3601513M	500%	1600%	GJL36015M03	400%	1500%
		10		14	FAL3603015M	700%	2500%	GJL36030M04	600%	2400%
	5			15.2	FAL3603015M	700%	2300%	GJL36030M04	600%	2200%
			15	17	FAL3603015M	600%	2100%	GJL36030M04	500%	1900%
5			5	17.5	FAL3603015M	600%	2000%	GJL36030M04	500%	1900%
		15		21	FAL3603015M	500%	1700%	GJL36030M04	400%	1600%
	7-1/2			22	FAL3605016M	700%	2600%	GJL36030M04	400%	1500%
7-1/2				25.3	FAL3605016M	600%	2300%	GJL36030M04	400%	1300%
		20	25	27	FAL3605016M	600%	2100%	GJL36050M05	600%	2000%
	10			28	FAL3605016M	500%	2100%	GJL36050M05	500%	2000%
			30	32	FAL3605016M	500%	1800%	GJL36050M05	500%	1700%
10				32.2	FAL3605016M	500%	1800%	GJL36050M05	500%	1700%
		25		34	FAL3605016M	400%	1700%	GJL36050M05	400%	1600%
		30		40	FAL3605016M	400%	1500%	GJL36050M05	400%	1400%
			40	41	FAL3610018M	700%	2700%	GJL36050M05	400%	1300%
	15			42	FAL3610018M	700%	2600%	GJL36075M06	400%	1300%
15				48.3	FAL3610018M	600%	2300%	GJL36075M06	500%	1700%
		40	50	52	FAL3610018M	600%	2100%	GJL36075M06	400%	1600%
	20			54	FAL3610018M	600%	2000%	GJL36075M06	400%	1500%
20			60	62	FAL3610018M	500%	1800%	GJL36075M06	400%	1300%
		50		65	FAL3610018M	500%	1700%	GJL36075M06	300%	1300%

Continued on next page

## Thermal-Magnetic / Magnetic Only Molded Case Circuit Breakers Magnetic Only Molded Case Circuit Breakers

**Table 48: Adjustable Instantaneous Trip Circuit Breakers for Single Motor Circuit Protection** (continued)

NOTE: Based on NEC 430.52 and NEC Table 430.150.

Hp Ratings of Induction Type Squirrel-cage and Wound Rotor Motors				★Full Load Amperes	Mag-Gard® Circuit Breaker Catalog No.	★★Magnetic Trip Settings		GJL Family Mag-Gard Circuit Breaker Catalog No.	★★Magnetic Trip Settings	
Three-Phase 60 Hz ac						MIN	MAX		MIN	MAX
200 Volts	230 Volts	460 Volts	575 Volts							
	25			68	FAL3610018M	400%	1600%			
		60	75	77	FAL3615024M	600%	1400%			
25				78.2	FAL3615024M	600%	1400%			
	30			80	FAL3615024M	600%	1400%			
30				92	KAL3625025M	700%	1400%			
		75		96	KAL3625025M	700%	1300%			
			100	99	KAL3625025M	600%	1300%			
	40			104	KAL3625026M	700%	1400%			
40				120	KAL3625029M	700%	1500%			
		100		124	KAL3625029M	700%	1400%			
			125	125	KAL3625029M	700%	1400%			
	50			130	KAL3625029M	700%	1300%			
			150	144	KAL3625030M	700%	1400%			
50				150	KAL3625030M	700%	1300%			
	60			154	KAL3625031M	700%	1500%			
		125		156	KAL3625031M	700%	1400%			
60				177.1	KAL3625032M	700%	1400%			
		150		180	KAL3625032M	700%	1400%			
	75		200	192	KAL3625032M	700%	1300%			
75				221	LAL3640033M	700%	1400%			
		200		240	LAL3640035M	700%	1500%			
			250	242	LAL3640035M	700%	1400%			
	100			248	LAL3640035M	700%	1400%			
100				285	LAL3640036M	700%	1400%			
			300	289	LAL3640036M	700%	1400%			
		250		302	LAL3640036M	700%	1300%			
	125			312	LAL3640036M	600%	1300%			
			350	336	MAL3660040M	700%	1500%			
125				359	MAL3660040M	700%	1400%			
	150			360	MAL3660040M	700%	1400%			
		300		361	MAL3660040M	700%	1400%			
			400	382	MAL3660040M	700%	1300%			
		350		414	MAL3660042M	700%	1400%			
			500	472	MAL3660044M	700%	1500%			
		400		477	MAL3660044M	700%	1500%			
	200			480	MAL3660044M	700%	1500%			
200				552	MAL3680045M	700%	1400%			
		500		590	MAL3680045M	700%	1400%			
	250			602	MAL3680045M	700%	1300%			

★ Motor full-load currents are taken from NEC Table 430.150. Select wire and circuit breakers on basis of horsepower rather than nameplate full-load current per NEC 430.6 (A) for general motor applications. Do not use these values to select overload relay thermal units. See Digest pages 14-129-14-152 for selection of thermal units when actual full load current is not known. The voltages listed are rated motor voltages. Corresponding nominal system voltages are 200 to 208, 220 to 240, 440 to 480 and 550 to 600 volts.

▲ See NEC 430.52 (A) for breaker settings above 800%.

■ If due to motor starting characteristics, trip settings at the 1300% maximum permitted level are needed, the next size Mag-Gard® circuit breaker should be chosen.

★★ Only MIN and MAX settings are shown, intermediate settings are available on all circuit breakers.

# Thermal-Magnetic / Magnetic Only Molded Case Circuit Breakers

## Magnetic Only Molded Case Circuit Breakers

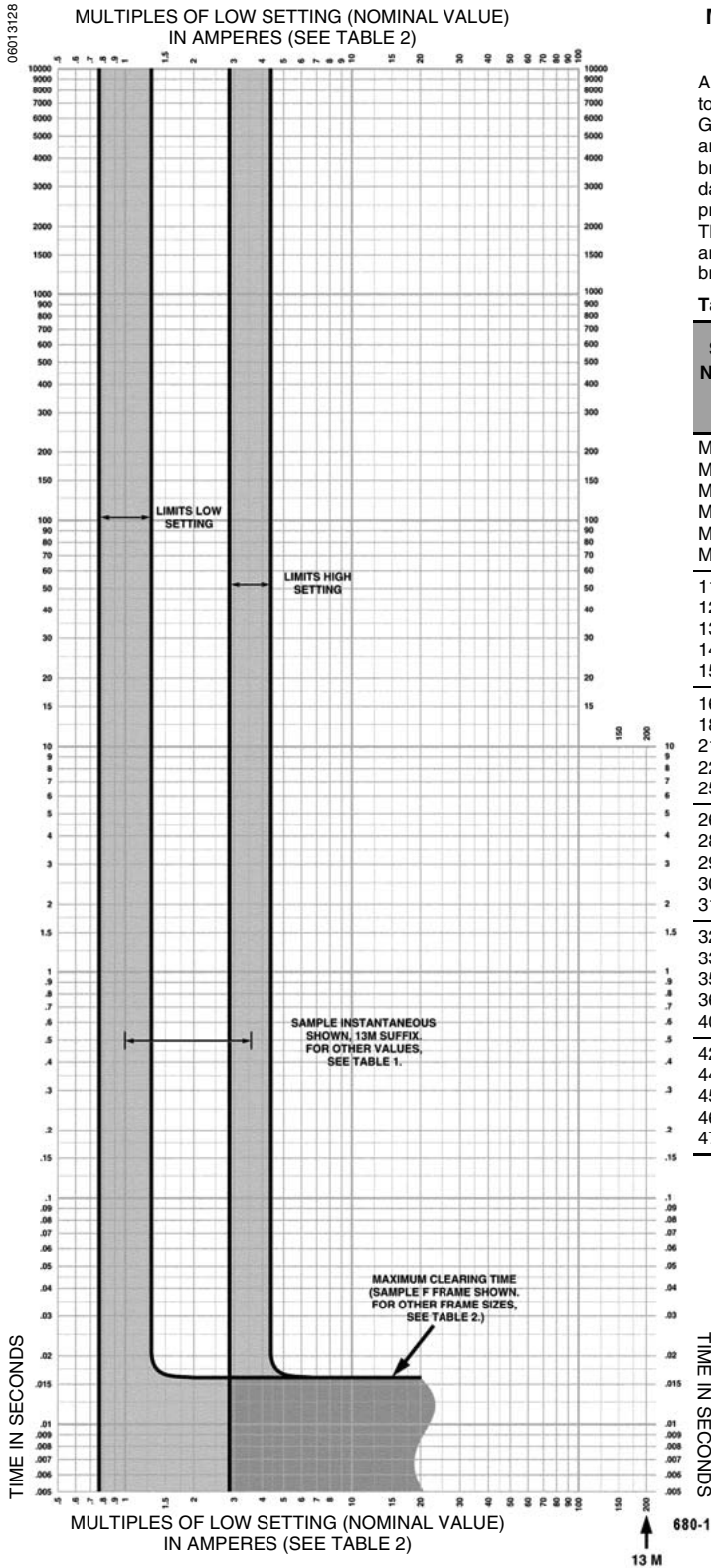

### MAG-GARD® INSTANTANEOUS TRIP MOLDED CASE CIRCUIT BREAKERS CHARACTERISTIC TRIP CURVE NO. 680-1

A Mag-Gard circuit breaker characteristic curve is shown. Any value of current to the right of the shaded area will trip the Mag-Gard circuit breaker. The Mag-Gard circuit breaker will not trip for any value of current to the left of the shaded area. For any value of current within the shaded area, the Mag-Gard circuit breaker will either hold in indefinitely or trip instantaneously. To prevent damage to the Mag-Gard circuit breaker, proper overload protection must be provided (NEC 430-52). The shaded area represents the UL 489 tolerances. They are  $\pm 25\%$  on low settings and  $\pm 20\%$  on high setting. Where trip values are not high enough due to excessive inrush currents, thermal-magnetic circuit breakers may be used if sized in accordance with NEC Table 430-152.

Table 1

Suffix Number	AC Magnetic Trip Setting Nominal Values		Align Arrow @
	Low	High	
M01	9	33	1111 Multiples
M02	21	77	476 Multiples
M03	45	165	222 Multiples
M04	90	330	111 Multiples
M05	150	550	67 Multiples
M06	225	825	44 Multiples
11M	8	28	1250 Multiples
12M	18	70	555 Multiples
13M	50	180	200 Multiples
14M	75	260	133 Multiples
15M	100	350	100 Multiples
16M	150	580	67 Multiples
18M	300	1100	33 Multiples
21M	400	800	25 Multiples
22M	500	1000	20 Multiples
25M	625	1250	16 Multiples
26M	750	1500	13 Multiples
28M	750	1600	13 Multiples
29M	875	1750	11 Multiples
30M	1000	2000	10 Multiples
31M	1125	2250	9 Multiples
32M	1250	2500	8 Multiples
33M	1500	3000	6.7 Multiples
35M	1750	3500	5.7 Multiples
36M	2000	4000	5 Multiples
40M	2500	5000	4 Multiples
42M	3000	6000	3.3 Multiples
44M	3500	7000	2.8 Multiples
45M	4000	8000	2.5 Multiples
46M	4500	8600	2.2 Multiples
47M	4500	9000	2 Multiples

Table 2

Frame Size	Maximum Clearing Time
G	.008 Seconds
F	.016 Seconds
K	.016 Seconds
L	.016 Seconds
M	.025 Seconds
N	.050 Seconds

Tripping curves for coordination studies are available upon request.

Curve No. 0680TC9401  
 Drawing No. B48095-680-01  
 (Replaces 680-1 dated 4/91)

# Thermal-Magnetic / Magnetic Only Molded Case Circuit Breakers Molded Case Switches

## MOLDED CASE SWITCHES

This section provides specific information on Square D® molded case switches. For more information, see the Introduction in this catalog.



KHL

### Description

**Table 49: Description of Molded Case Switches**

Circuit Breaker	Description
Molded Case Switches	100–2500 ampere, 600 Vac, 50/60 Hz, 2- and 3- pole automatic molded case switches

### Reverse Connection

Square D, molded case switches have been fully tested and are UL listed for reverse connection without restrictive “LINE” or “LOAD” markings.

### Selection Data

**Table 50: Molded Case Switches**

Ampere Rating	2-Pole	3-Pole	UL Listed Withstand Rating (kA) <sup>★</sup>				Trip Point - Amps. (Automatic Switch)		Lug Kit Installed
	Catalog No.	Catalog No.	240 Vac	480 Vac	600 Vac	250 Vdc	AC <sup>▲</sup>	DC <sup>▲</sup>	
600 Vac Automatic									
100	FHL26000M	FHL36000M	65	25	18	10	1500	1725	AL100FA
150	—	FHL3600015M	65	25	18	—	2500	—	AL150FA
250	KHL26000M	KHL36000M	65	35	25	10	4500	5175	AL250KA
400	LHL26000M	LHL36000M	65	35	25	10	8000	9600	AL400LA
600	MHL260006M	MHL360006M	65	65	25	10	9000	9900	AL900MA
800	MHL260008M	MHL360008M	65	65	25	10	9000	9900	AL900MA
1000	MHL26000M	MHL36000M	65	65	25	10	9000	9900	AL900MA
1200	NCL2600012M	NCL3600012M	125	100	65	—	16000	N/A	AL1200N E6
2000	PHF260000M	PHF360000M	125	100	65	—	16000	N/A	N/A
2500	PCF260000M	PCF360000M	125	100	65	—	16000	N/A	N/A

<sup>★</sup> The “Withstand Rating” is the maximum current, at rated voltage, that the molded case switch will withstand without damage when protected by a circuit breaker with an equal continuous current rating.

<sup>▲</sup> UL magnetic trip setting tolerances are ±20% from the nominal values shown.

# Thermal-Magnetic / Magnetic Only Molded Case Circuit Breakers Molded Case Switches

## Powerpact® Selection Data

NOTE: For Powerpact selection information see Class 611, 612, 613, and 734 catalogs.



07340300

Q-frame: Class 734



06113477

H-frame: Class 611



06113484

J-frame: Class 611



06123321

M-frame: Class 612

# Thermal-Magnetic / Magnetic Only Molded Case Circuit Breakers Molded Case Switches

## Dimensions

06013130

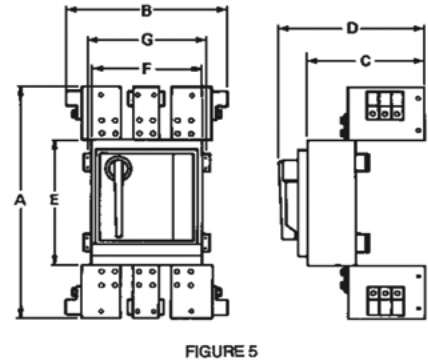
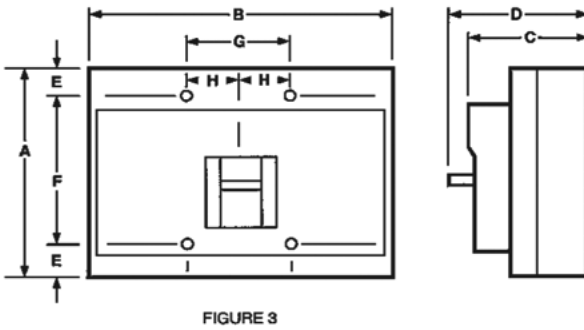
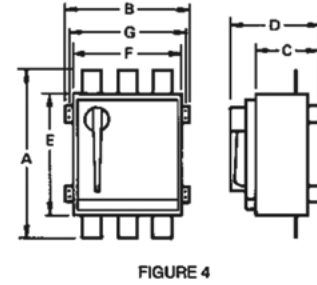
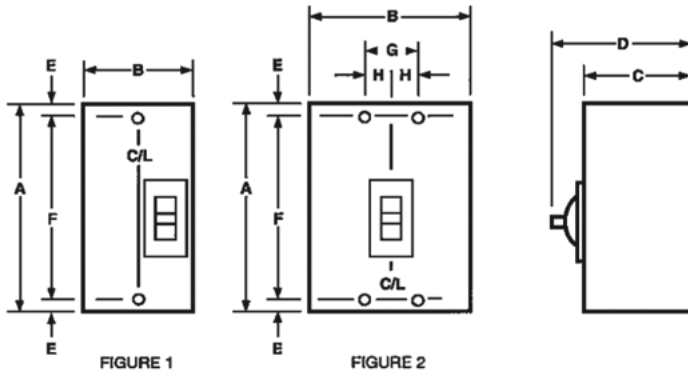

Molded Case Switch Catalog Number Prefix	No. Poles	Figure No.	Dimension — Inches							
			A	B	C	D	E	F	G	H
FHL	2	1	6	3	3.16	4.13	.44	5.13	....	....
	3	2	6	4.47	3.16	4.13	.44	5.13	1.5	.75
KHL	2 & 3	2	8	4.47	3.66	4.75	.44	7.13	1.5	.75
LHL	2 & 3	2	11	5.97	4.06	5.84	.88	9.25	2	1
MHL	2 & 3	2	14	8.97	4.53	6.5	1.66	10.69	3	1.5
NCL	2 & 3	3	12.12	14.98	6.40	8.07	1.69	8.75	5.00	.250
PHF	2 & 3	4	20.10	13.75	7.25	10.41	14.00	12.00	12.75	....
PCF	2 & 3	5	26.10	23.30	13.33	16.48	14.00	12.00	12.75	....

# Thermal-Magnetic / Magnetic Only Molded Case Circuit Breakers Accessories

## ACCESSORIES

*NOTE: For Powerpact® and Masterpact® accessory information see Class 611, 612, 613, and 734 catalogs.*

This section describes the UL Listed accessories available for Square D® thermal-magnetic molded case circuit breakers, Mag-Gard® magnetic only instantaneous trip circuit breakers and molded case switches. These accessories increase application versatility and meet the demands of modern electrical distribution systems.

The following table lists the accessories available for Square D thermal-magnetic circuit breakers, magnetic only circuit breakers and molded case switches.

**Table 51: Accessories Available**

Accessory	Circuit Breaker Frame																						
	FA	FH	FC	FI	FY	QB <sup>▲</sup> QD <sup>▲</sup> QG <sup>▲</sup> QJ <sup>▲</sup>	KA	KH	KC	KI	Q4	LA	LI	LC	LH	MA	MH	NA	NC	PAF	PHF	PCF	
Shunt Trip	X	X	X	X			X	X	X	X	X	X	X	X	X	X	X	X	X	X	X	X	X
Ground Fault Shunt Trip	X	X	X	X			X	X	X	X	X	X			X	X	X	X	X	X	X	X	X
Undervoltage Trip	X	X	X	X			X	X	X	X	X	X	X	X	X	X	X	X	X	X	X	X	X
Auxiliary Switch	X	X	X	X			X	X	X	X	X	X	X	X	X	X	X	X	X	X	X	X	X
Alarm Switch	X	X	X	X			X	X	X	X	X	X	X	X	X	X	X	X	X	X	X	X	X
Cylinder Lock★	X	X	X	X			X	X			X	X			X	X	X						
Ground Fault Module	X	X	X	X			X	X	X	X													
Handle Padlock Attachment	X	X	X	X	X	X	X	X	X	X	X	X	X	X	X	X	X	X	X	X	X	X	X
Walking Beam	X						X					X			X	X	X						
Front Mount Mechanical Interlock						X																	
Combination Handle Tie and Lock Off	X	X	X	X	X			X															
Handle Extension	X	X	X	X			X				X	X	X	X	X	X	X	X	X	X			
Electrical Operator	X	X	X	X			X				X	X			X	X	X			X	X	X	X

★ Cylinder locks not available on FA/FH Mag-Gard circuit breakers.

▲ For Powerpact Q-frame information see Class 734.

## Factory and Field Installation Types

*NOTE: See Catalog Numbers for an explanation of the catalog numbering system.*

Some electrical accessories are factory installed while others are field installable.

### ■ Factory Installed Accessories

Factory installed accessories are internally mounted and provided with minimum 18-inch lead wires. Factory installed devices cannot be removed or repaired in the field.

Factory installed accessories are ordered by adding the correct suffix number to the standard circuit breaker catalog number (i.e., a 3-pole, 600 Vac, 100 ampere molded case circuit breaker with a 120/240 Vac shunt trip would be FAL361001021). Suffix numbers for some combinations of factory

## Thermal-Magnetic / Magnetic Only Molded Case Circuit Breakers Accessories

installed electrical accessories are listed in this section. If the combination is not listed in one of the tables, order the combination by description.

The table below shows suffix numbers for the following combinations of factory installed accessories for the FA, FH, FC, FI, KA, KH, KC, and KI thermal-magnetic circuit breakers, magnetic only circuit breakers and molded case switches. Additional combinations are available; please contact your local Square D® sales office: 1-888 Square D.

**Table 52: Suffixes for Factory Installed Accessories**

NOTE: The FA 1-pole Circuit Breaker is not included in this table.

Device Suffix	Shunt Trip		Shunt Trip			Undervoltage Trip		Undervoltage Trip		Auxiliary Switches			Not Compatible With:
	24 Vdc	48 Vdc	24 Vac	120/240 Vac	277/480 Vac	24 Vdc	48 Vdc	120 Vac	240 Vac	1A-1B	2A-2B	3A-3B	
1027	X												
1386	X									X			FA 2P
1426	X										X		FA 2P
1472	X											X	FA 2P, FA 3P, FI, KC, KI
1028		X											
1390		X								X			FA 2P
1433		X									X		FA 2P
1477		X										X	FA 2P, FA 3P, FI, KC, KI
1042			X										
1441			X							X			FA 2P
1442			X								X		FA 2P
1021				X									
1380				X						X			FA 2P
1422				X							X		FA 2P
1466				X								X	FA 2P, FA 3P, FI, KC, KI
1037					X								
1388					X					X			FA 2P
1427					X						X		FA 2P
1127						X							
1616						X				X			FA 2P
1625						X					X		FA 2P
1128							X						FI, KC, KI
1627							X				X		FA, 2P, FI, KC, KI
1670							X					X	FA 2P, FA 3P, FI, KC, KI
1121								X					
1590								X		X			FA 2P
1595								X			X		FA 2P
1631								X				X	FA 2P, FA 3P, FI, KC, KI
1124									X				
1581									X	X			FA 2P
1619									X		X		FA 2P

Continued on next page

# Thermal-Magnetic / Magnetic Only Molded Case Circuit Breakers Accessories

**Table 52: Suffixes for Factory Installed Accessories (continued)**

NOTE: The FA 1-pole Circuit Breaker is not included in this table.

Device Suffix	Shunt Trip		Shunt Trip			Undervoltage Trip		Undervoltage Trip		Auxiliary Switches			Not Compatible With:
	24 Vdc	48 Vdc	24 Vac	120/240 Vac	277/480 Vac	24 Vdc	48 Vdc	120 Vac	240 Vac	1A-1B	2A-2B	3A-3B	
1611									X			X	FA 2P, FA 3P, FI, KC, KI
1212										X			FA 2P use 1202 suffix
1352											X		
1354											X <sup>★1</sup>		FA 2P
1364												X <sup>★2</sup>	FA 2P
1218												X <sup>★3</sup>	FA 2P, FA 3P, FI, KC, KI

★1—Circuit breaker has 2 sets of 2A2B auxiliary contacts.

★2—The FA 3-pole, FI, KC, and KI circuit breakers will include 1A1B in the left pole and 2A2B in the right pole to achieve 3A3B.

★3—Circuit breaker has 2 sets of 3A3B contacts.

■ Factory Installed Combinations of Electrical Accessories

**Table 53: Available Factory Installed Accessory Combinations**

FA, FH, FC and FI Thermal-Magnetic Circuit Breakers				KA and KH Circuit Breakers		KC and KI Circuit Breakers	
Accessory	1-Pole	2-Pole	3-Pole	Accessory	2, 3 Pole	Accessory	2, 3 Pole
A/S (1A1B or 2A2B)		X	X	A/S (1A1B or 2A2B or 3A3B)	X	A/S (1A1B or 2A2B)	X
A/S (3A3B or 4A4B)			X	A/S (4A4B or 5A5B or 6A6B)	X	A/S (3A3B or 4A4B)	X
A/S (1A1B or 2A2B), B/A		X	X	A/S (1A1B or 2A2B or 3A3B), B/A	X	A/S (1A1B or 2A2B), B/A	X
A/S (3A3B or 4A4B), B/A			X	A/S (4A4B or 5A5B or 6A6B), B/A	X	A/S (3A3B or 4A4B), B/A	X
A/S (1A1B or 2A2B), B/A, S/T			X	A/S (1A1B or 2A2B or 3A3B), B/A, S/T	X	A/S (1A1B or 2A2B), B/A, S/T	X
A/S (1A1B or 2A2B), S/T			X	A/S (1A1B or 2A2B or 3A3B), S/T	X	A/S (1A1B or 2A2B), S/T	X
A/S (1A1B or 2A2B), B/A, UVR			X	A/S (1A1B or 2A2B or 3A3B), B/A, UVR	X	A/S (1A1B or 2A2B), B/A, UVR	X
A/S (1A1B or 2A2B), UVR			X	A/S (1A1B or 2A2B or 3A3B), UVR	X	A/S (1A1B or 2A2B), UVR	X
B/A	X	X	X	B/A	X	B/A	X
B/A, S/T		X	X	B/A, S/T	X	B/A, S/T	X
B/A, UVR		X	X	B/A, UVR	X	B/A, UVR	X
S/T		X	X	S/T	X	S/T	X
S/T, B/A, UVR			X	S/T, B/A, UVR	X	S/T, B/A, UVR	X
S/T, UVR			X	S/T, UVR	X	S/T, UVR	X
UVR		X	X	UVR	X	UVR	X
CL			X	CL	X	CL	X
CL, A/S (1A1B or 2A2B)			X	CL, A/S (1A1B or 2A2B or 3A3B)	X	CL, A/S (1A1B or 2A2B)	X
CL, B/A, A/S (1A1B or 2A2B)			X	CL, B/A, A/S (1A1B or 2A2B or 3A3B)	X	CL, B/A, A/S (1A1B or 2A2B)	X
CL, B/A			X	CL, B/A	X	CL, B/A	X
CL, B/A, S/T			X	CL, B/A, S/T	X	CL, B/A, S/T	X
CL, S/T			X	CL, S/T	X	CL, S/T	X
CL, B/A, UVR			X	CL, B/A, UVR	X	CL, B/A, UVR	X
CL, UVR			X	CL, UVR	X	CL, UVR	X

Cylinder Lock not available on FA/FH Mag-Gard®

LEGEND - A/S=Auxiliary Switch, B/A=Bell Alarm, S/T=Shunt Trip, UVR=Undervoltage Trip, CL=Cylinder Lock

## Thermal-Magnetic / Magnetic Only Molded Case Circuit Breakers Accessories

### ■ Field Installable Accessories

Field installable accessories can be installed, interchanged or replaced in the field without affecting the circuit breaker's UL listing or interrupting ratings. Field installable accessories cannot be used in a mounting location or a pole that has a factory installed only accessory. Field installable electrical accessories and circuit breakers are shipped separately. The following thermal-magnetic circuit breakers, magnetic only circuit breakers and molded case switches accept UL Listed, Square D® field installable accessories:

- Q4, LA, and LH Series 4 and higher
- LI and LC Series 1 and higher
- MA and MH Series 2 and higher
- PA, PH, and PC Series 4 and higher
- NA and NC Series 1 and higher

### Shunt Trip

The shunt trip accessory is used to trip the circuit breaker from a remote location by using a trip coil energized from a separate circuit. When energized by a push button or other pilot device, the shunt trip causes the circuit breaker to trip. The trip coil has coil clearing contacts to break the coil circuit when the circuit breaker opens.

Shunt trips are available for 2- and 3-pole thermal-magnetic circuit breakers, magnetic only circuit breakers and molded case switches with standard control voltage ratings to 480 Vac or 24 Vdc. Additional ac control voltage ratings to 600 Vac are supplied with a 120 Vac rated coil and a control voltage transformer for user mounting. Control voltages above 480 Vac are not UL Listed. A 120 Vac shunt trip operates at 55% or more of rated voltage and all other shunt trips operate at 75% or more of rated voltage.

### Ground Fault Shunt Trip

A ground fault shunt trip operates in the same manner as a standard shunt trip, except that since the trip coil is rated for continuous duty, no coil clearing contact is needed. This accessory was designed for use with the Micrologic® Ground Fault Module (GFM).

**Table 54: Shunt Trip—Selection Data**

	Control Voltage	Factory Installed Shunt Trip Suffix	Field Installable Shunt Trip Catalog Number★
Shunt Trip	24 Vac 50/60 Hz	1042	( ) 1042
	48 Vac 50/60 Hz	1048	( ) 1048
	120–240 Vac 50/60 Hz	1021	( ) 1021
	120–240 Vac 400 Hz	1046▲	( ) 1046▲
	208–480 Vac 50/60 Hz	—	( ) 1086■
	277–480 Vac 50/60 Hz	1037	( ) 1037★★
	600 Vac 50/60 Hz	1026▲	( ) 1026▲
	6 Vdc	1040	( ) 1040
	12 Vdc	1039	( ) 1039
	24 Vdc	1027	( ) 1027
	48 Vdc	1028	( ) 1028
	72 Vdc	1038	( ) 1038
	125 Vdc	1029	( ) 1029
	250 Vdc	1030	( ) 1030
Ground Fault Shunt Trip	24 Vac 50/60 Hz	G	( ) G★★

★ Complete accessory catalog number by adding appropriate circuit breaker prefix (LA1, MA1, NA1, or PA1).

▲ Not UL Listed

■ PA1 prefix only.

★★ Not available with PA1 prefix.

# Thermal-Magnetic / Magnetic Only Molded Case Circuit Breakers Accessories

Figure 22: Ground Fault and Shunt Trip Wiring Diagram

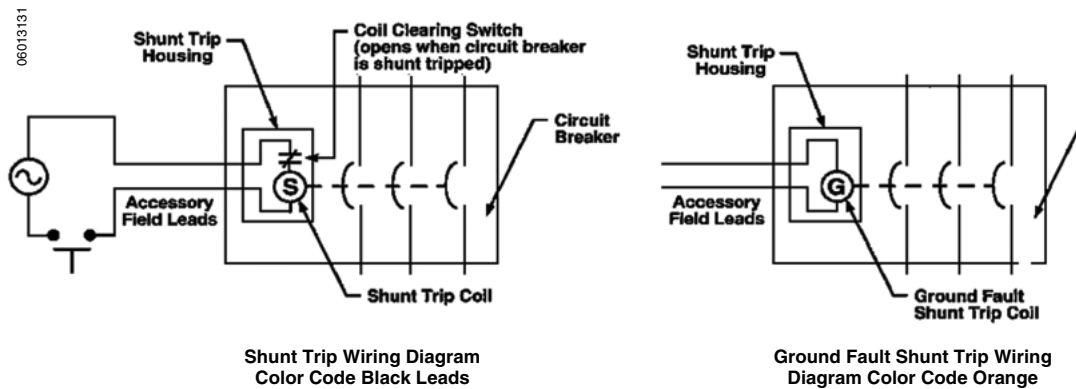

Table 55: Shunt Trip Electrical Specifications

Voltage Rating		Maximum Current in Milliamps (RMS)	Coil Burden Max. VA	Minimum Recommended Supply Transformer (VA)
AC	24	850 (3650)	20.4 (88)	25
	48	540	26	50
	120	240 (4000)	29 (54)	50
	208	515 (500)	107 (104)	50
	240	740	154	50
	277	50	13.9	25
	480	93	44.6	50
DC	6	1714 (6000)	10.3 (36)	—
	12	800 (6000)	9.6 (72)	—
	24	1500 (460)	36 (11)	—
	48	750 (920)	36 (44)	—
	72	200 (208)	14.4 (15)	—
	125	350 (80)	43.7 (10)	—
	250	60 (160)	15 (40)	—

( ) Values in parenthesis apply to field installable devices used in PA/PC frame breakers.

Table 56: Shunt Trip & Undervoltage Trip Clearing Times

Circuit Breaker	Average Clearing Time, Milliseconds
FA	16
KA	20
LA, Q4	25
MA	33
NA	35
PA, PC	40

## Undervoltage Trip

The undervoltage trip accessory reduces the possibility of damage to the electrical equipment when a reduction or loss of system voltage occurs. When the voltage drops below a level established by UL 489 requirements for more than 3 milliseconds, the undervoltage trip mechanism (undervoltage trip release) trips the circuit breaker or molded case switch and prevents it from being reclosed until this voltage level is restored.

## Thermal-Magnetic / Magnetic Only Molded Case Circuit Breakers Accessories

**Table 57: UL 489 Undervoltage Trip Requirements**

To Trip Circuit Breaker	Undervoltage Trip <b>MUST</b> Trip	Undervoltage Trip <b>MAY</b> Trip	Undervoltage Trip <b>MUST NOT</b> Trip
Percent of Rated Voltage	0%	35% 70%	85% 100%
To reseal Undervoltage Trip		Undervoltage Trip <b>MAY</b> Pickup and Seal	Undervoltage Trip <b>MUST</b> Pickup and Seal

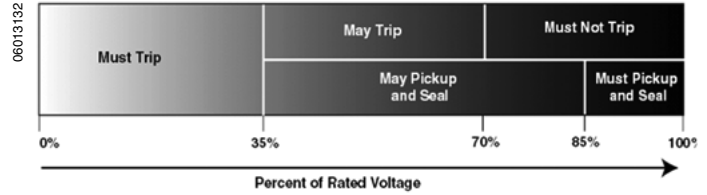

Undervoltage trip accessories are available on 2- and 3-pole circuit breakers and molded case switches with standard control voltage ratings to 240 Vac or 24 Vdc. Additional ac control voltage ratings up to 600 Vac can be supplied with a 120 Vac rated device and control voltage transformer for user mounting. Optional dc voltage ratings up to 250 Vdc are available and can be supplied with a 24 Vdc undervoltage trip release and a step down resistor for field installation. Voltage ratings above 24 Vac or 240 Vdc are not UL listed.

**Table 58: Undervoltage Trip—Selection Data**

Voltage	Factory Installed Suffix	Field Installable Catalog Number★
24 Vac 50/60 Hz	1143	( ) 1143
48 Vac 400 Hz	1157▲	( ) 1157▲
120 Vac 50/60 Hz	1121	( ) 1121
208 Vac 50/60 Hz	1122	( ) 1122
240 Vac 50/60 Hz	1124	( ) 1124
277 Vac 50/60 Hz	1142▲	( ) 1142▲
380 Vac 50/60 Hz	1148▲	( ) 1148▲
415 Vac 50/60 Hz	1149▲	( ) 1149▲
440 Vac 50/60 Hz	1134▲	( ) 1134▲
480 Vac 50/60 Hz	1125▲	( ) 1125▲
600 Vac 50/60 Hz	1126▲	( ) 1126▲
6 Vdc	1136	( ) 1136
12 Vdc	1133	( ) 1133
24 Vdc	1127	( ) 1127
48 Vdc	1128■	( ) 1128▲
72 Vdc	1135■	( ) 1135▲
125 Vdc	1129■	( ) 1129▲
250 Vdc	1130■	( ) 1130▲

★ Complete accessory catalog number by adding appropriate circuit breaker prefix (LA1, MA1, NA1, or PA1). **Compatibility with circuit breaker must be verified.**

▲ Not UL Listed.

■ UL Listed only on PA, PC, PE circuit breakers.

# Thermal-Magnetic / Magnetic Only Molded Case Circuit Breakers Accessories

## Undervoltage Trip Time-delay Unit

The undervoltage trip time-delay unit, when connected in series with a 120 Vac undervoltage trip, introduces an adjustable time delay of .1 to .6 seconds in the release of the undervoltage trip coil. This prevents momentary voltage fluctuations from releasing the undervoltage trip coil and nuisance tripping the circuit breaker.

The time delay unit can be mounted separately (Catalog Number UVTD), or mounted in a 1-1/2-inch single pole FA I-Line® circuit breaker space (Catalog Number UVTD1). It can be wired into existing circuits already equipped with 120 Vac undervoltage trip.

**Table 59: Undervoltage Trip Electrical Specifications**

Voltage Rating	Maximum Current in Milliamps (RMS)	Maximum Inrush	Coil Burden (VA) Sealed	Minimum Recommended Supply Transformer (VA)
AC	24	170	4.1	25
	120	63	7.6	25
	208	30	6.2	25
	240	32	7.6	25
	★277	63	7.6	25
	★380	63	7.6	25
	★415	63	7.6	25
	★440	63	7.6	25
	★480	63	7.6	25
★600	63	7.6	5.4	25
DC	6	400	2.4	—
	12	185	2.2	—
	24	69	1.6	—
	▲48	64	3.1	—
	▲72	45	3.2	—
	▲125	40	5	—
	▲250	21	5.2	—
	▲300	21	6.2	—

★ Includes a separate control voltage transformer. (Not UL Listed).

▲ Includes a separate resistor.



# Thermal-Magnetic / Magnetic Only Molded Case Circuit Breakers Accessories

## Auxiliary Switch

The auxiliary switch accessory monitors the circuit breaker's contact status and provides a remote signal indicating whether the contact is open or closed. When the circuit breaker is in the OFF or tripped state, the auxiliary switch's A contact is open and the B contact is closed. When the circuit breaker is ON, the B contact is open and the A contact is closed.

### Maximum Ratings:

- 10 Ampere     120 Vac or 240 Vac
- 1/3 hp        120 Vac or 240 Vac (1/4 hp-FA and KA)
- 4 Ampere     120 Vac lamp load
- 1/2 Ampere   120 Vdc
- 1/4 Ampere   120 Vdc

**Table 60: Auxiliary Switch—Selection Data**

Type of Contacts	Factory Installed Suffix	Field Installable Catalog Number
1A and 1B	1212	( ) 1212
2A and 2B	1352	( ) 1352
3A and 3B	1364	( ) 1364★

★ Complete accessory catalog number by adding appropriate circuit breaker prefix (LA1, MA1, NA1 or PA1).

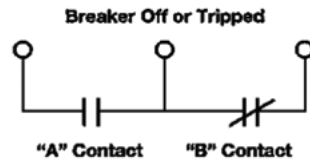
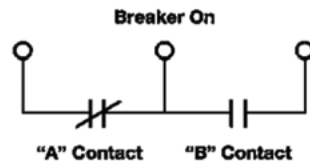
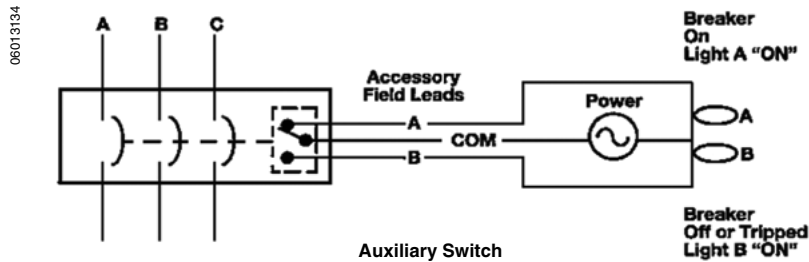

**Color Code: "A" Contact—Yellow Leads, "B" Contact—Blue Leads, Common—Striped Leads**

Auxiliary Switch Wiring Diagram

# Thermal-Magnetic / Magnetic Only Molded Case Circuit Breakers Accessories

## Alarm Switch

The alarm switch accessory monitors the circuit breaker's trip status and is used to provide a remote warning signal indicating the circuit breaker has tripped. This signal can be used in conjunction with a horn, pilot light or some other indicator.

The contact on the standard alarm switch is open when the circuit breaker is in the OFF or ON position and is closed when the circuit breaker is in the tripped position.

Alarm switches are actuated when the circuit breaker is tripped as a result of an overload, short circuit, undervoltage trip operation, shunt trip operation or a result of a manual Push-To-Trip operation.

Standard construction is with Normally Open (N.O.) contacts. Maximum ratings are 7A at 120 Vac or 240 Vac.

**Table 61: Alarm Switch—Selection Data**

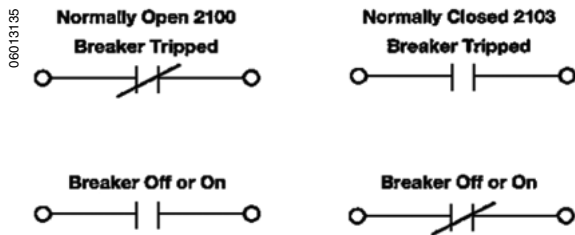

Type of Contacts	Factory Installed Suffix	Field Installable Catalog Number <sup>★</sup>
Normally Open	2100	( ) 2100
Normally Closed	2103 <sup>▲</sup>	( ) 2103 <sup>▲</sup>

<sup>★</sup> Complete accessory catalog number by adding appropriate circuit breaker prefix (NA1 only).

<sup>▲</sup> Not UL listed.

**Table 62: Endurance Operations For Electrical Accessories**

Circuit Breaker Frame Size	UL 489 Operations				Square D <sup>®</sup> Certified Operations	
	Circuit Breaker		Auxiliary Switch	Shunt Trip UVR Alarm Switch	Auxiliary Switch	Shunt Trip UVR Alarm Switch
	Load	No Load				
100 Ampere	6,000	4,000	10,000	600	10,000	10,000
	6,000	4,000	10,000	600	10,000	10,000
225 Ampere	4,000	4,000	8,000	400	8,000	8,000
250 Ampere	1,000	5,000	6,000	100	6,000	6,000
400 Ampere	1,000	5,000	1,000	100	6,000	6,000
600 Ampere	500	2,000	500	50	2,500	2,500
800 Ampere	500	2,000	500	50	2,500	2,500
1200 Ampere	500	2,000	500	50	2,500	2,500
2500 Ampere	500	2,000	500	50	2,500	2,500

Operations are at rated voltage and current.

One tripping operation is defined as a close-trip-reset operation of the circuit breaker.

# Thermal-Magnetic / Magnetic Only Molded Case Circuit Breakers Accessories

## Micrologic® Ground Fault Module



Ground Fault Module

The Micrologic Ground Fault Module (GFM) is a UL Listed self-powered ground fault sensing device that signals a circuit breaker ground fault shunt trip. It is available for use with unit mount or I-Line® construction circuit breakers.

**Table 63: Ground Fault Module—Selection Data**

Companion Circuit Breaker Prefix	Catalog Number	Enclosure Space Required		Ground Fault Pickup Adjustment Range Amperes
		Panelboard	Switchboard / Enclosure	
FAL, FHL, FCL, FA, FH, FC	GFM100FA	LA	KA	20–100
FIL, FI	GFM100FI	LA	LA	20–100
KAL, KHL, KCL, KIL, KA, KH, KC, KI	GFM250	LA	LA	40–200

Fewer components are required at the branch level since the GFM eliminates the need for a control test panel and relay device. The integral Push-To-Test button allows testing at the job site and eliminates the need for costly primary injection testing. The GFM uses electronic circuitry to provide branch circuit ground fault protection using a compact module that mounts directly to the OFF and lugs of the circuit breaker. By eliminating the need for wiring external ground fault relays and sensors, the GFM saves space and reduces labor costs.

**Standard features include:**

- All GFMs supplied for I-line mounting, are easily converted to unit mount by removing the I-line brackets.
- Molded case circuit breakers using the GFM require a ground fault shunt trip (add suffix G to the circuit breaker catalog number when ordering).
- All GFMs must be used with a 3-pole breaker.
- Up to 200,000 ampere short circuit withstand rating at 600 Vac.

■ Adjustable ground fault pickup settings

GFM100FA and GFM100FI modules are adjustable from 20 ampere through 100 ampere. GFM250 module is adjustable from 40 ampere through 200 ampere.

■ Adjustable ground fault delay settings

Actual time-delay varies with the magnitude of the ground fault.

■ Sealable adjustments

A clear plastic shield that fits over posts protruding from the module and can be sealed by attaching a sealing wire through the hole in the posts.

■ Integral Push-To-Trip Button

A button on the face of the GFM allows testing of the ground fault system without the need for any peripheral equipment. This meets the requirements of NEC230-95(c).

*NOTE: A 120Vac 60Hz power source capable of supplying 0.5A is required to power the test feature.*

■ Zone selective interlocking

Zone selective interlocking (ZSI) is standard with upstream Micrologic trip system circuit breakers. The GFM can also be zone interlocked with the GC-100 ground fault system by using a restraint interface module (Catalog Number RIM32).

■ Ground fault indication

A pop-out indicator on the face of the GFM indicates the module has sensed a ground fault and initiated a tripping signal to the companion circuit breaker.

■ Neutral current transformer

A neutral current transformer (CT) is supplied with each GFM for 3-phase 4-wire applications or 1-phase 3-wire applications.

# Thermal-Magnetic / Magnetic Only Molded Case Circuit Breakers Accessories

Figure 23: Ground Fault Module Dimensions

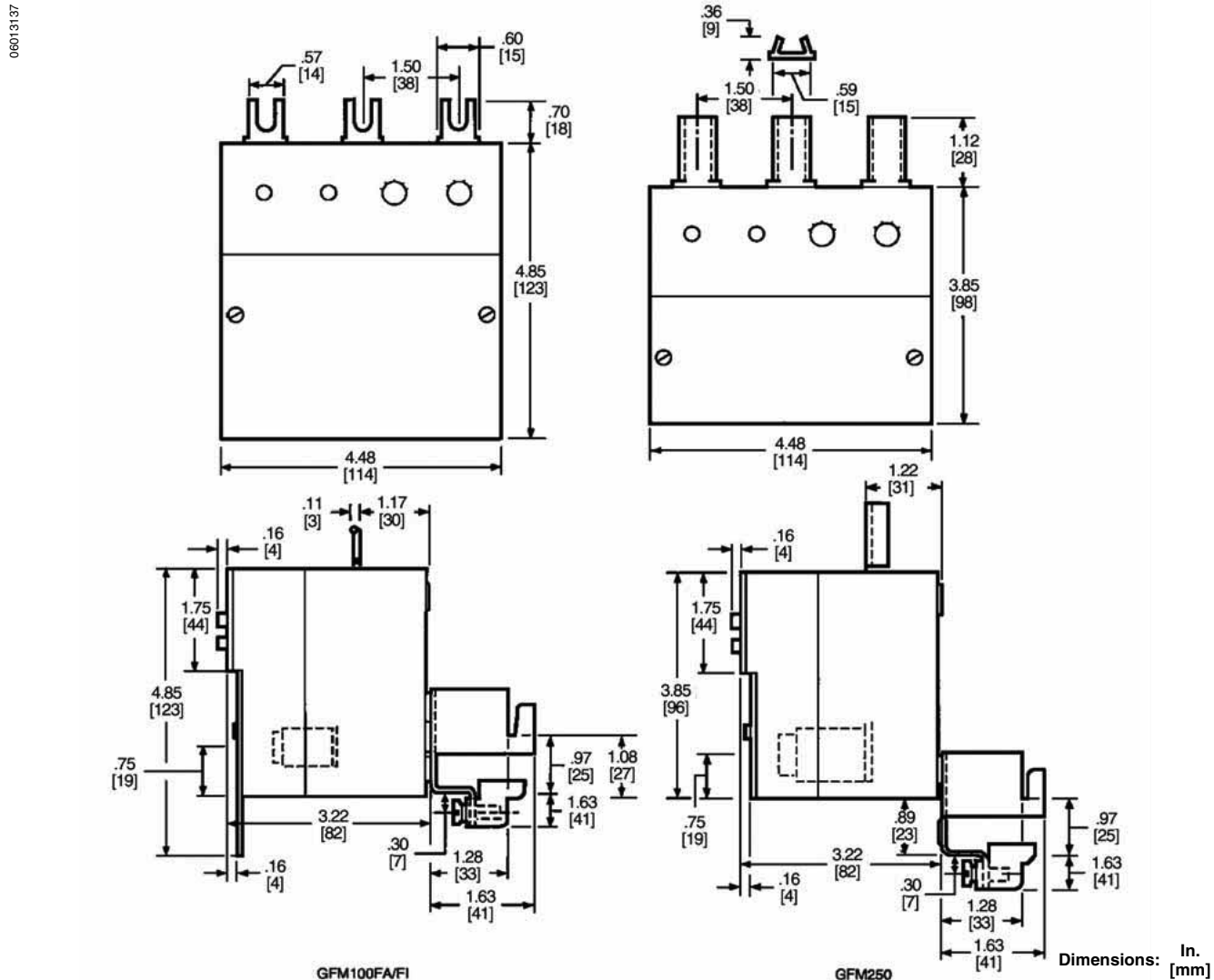

## Electrical Operators

Electrical operators provide ON, OFF and reset control from remote location of thermal-magnetic molded case circuit breakers, magnetic only molded case circuit breakers and molded case switches. When a remote indication of the circuit breaker status is required, use of circuit breaker with a 1A1B auxiliary switch for ON-OFF indication or with an alarm switch for trip indication.

### ■ Electrical Operator Endurance

The UL Standard 489 endurance requirement for an electrical operator is equal to the circuit breaker's no-load endurance requirement. For example, 100 ampere circuit breakers are required to sustain a minimum of 4,000 operations to meet UL requirements. There are two types of electrical operators available: side mount and top mount.

### ■ Side Mount Electrical Operators (MO1)

Side mount electrical operators are field installable on FA, FH, FC, FI, KA, KH, KC, KL, Q4, LA, LH, MA and MH families of molded case circuit breakers and molded case switches. Unit mount circuit breakers require a separate mounting pan to mount the circuit breaker flush with the electrical operator. The operators may be field installed on circuit breakers in I-Line® panelboards and



FAMO1

## Thermal-Magnetic / Magnetic Only Molded Case Circuit Breakers Accessories

switchboards without a mounting pan, but require 4-1/2 inches of circuit breaker mounting space. The operators require a single pole, double throw maintained contact switch and 120 Vac control voltage.

■ **Top Mount Electrical Operators (MO2)**

Top mount electrical operators are field installable on KA, KH, KC, KL, Q4, LA, LH, MA, MH, PA, PH and PC families of circuit breakers. They are intended for use on indoor, NEMA Type 1 applications. The top mount electrical operator requires a single pole, double throw switch and the proper control voltage.

The PAMO2 is an electronically controlled motor-gear reduction operating mechanism that installs to the top surface of a PA, PH or PC circuit breaker or molded case switch. The device can be operated in the ON or OFF position using low energy control circuitry. The PAMO2 requires momentary, continuous or solid state contacts and the correct control voltages.

**Table 64: Electrical Operators**

Characteristics Of Electrical Operators					
Motor Operator Catalog No.	Circuit Breaker Prefix	Closing Time (Sec.)	Current (Amps)		Endurance Operations
			Inrush (Peak)	Cont.	
<b>Side Mount Motor Operators</b>					
FAMO1	FA/FH/FC/FI	.80	2.0	.71	4000
KAMO1	KA/KH/KC/KI	.90	2.0	.71	4000
LAMO1	Q4/LA/LH	.65	18.0	4.2	3000
MAMO1	MA/MH	.65	18.0	4.2	3000
<b>Top Mounted Motor Operators</b>					
KAMO2120AC5C	KA/KH/KC/KI	.30	13.6	5.5	5000
KAMO2120AC	KA/KH/KC/KI	.30	16.0	6.0	5000
KAMO2240AC	KA/KH/KC/KI	.30	7.0	3.0	5000
KAMO224DC	KA/KH/KC/KI	.30	35.0	22.5	5000
KAMO2125DC	KA/KH/KC/KI	.30	13.2	6.6	5000
LAMO2120AC5C	Q4/LA/LH	.30	13.6	5.0	5000
LAMO2120AC	Q4/LA/LH	.30	14.0	5.5	5000
LAMO2240AC	Q4/LA/LH	.30	7.0	3.0	5000
LAMO224DC	Q4/LA/LH	.30	35.0	22.5	5000
LAMO2125DC	Q4/LA/LH	.30	13.2	6.6	5000
MAMO2120AC5C	MA/MH	.30	23	9.4	5000
MAMO2120AC	MA/MH	.30	14.0	5.5	5000
MAMO2240AC	MA/MH	.30	7.0	3.0	5000
MAMO224DC	MA/MH	.30	35.0	22.5	5000
MAMO2125DC	MA/MH	.30	13.2	6.5	5000
PAMO2	PA/PH/PC	.30	40.0	10.0	5000

Electrical Operator—Selection Data				
Motor Operator Catalog No.	Circuit Breaker Prefix	Control Voltage	Recommend-ed Control Transformer	Mounting Pan Cat. No.
<b>Side Mount Motor Operators</b>				
FAMO1	FA/FH/FC/FI	120 Vac	EO-1 50VA	N/A
	FAL/FHL/FC L/FIL			FAMOP
KAMO1	KA/KH/KC/KI	120 Vac	EO-1 50VA	N/A
	KAL/KHL/KC L/KIL			KAMOP
LAMO1	Q4/LA/LH	120 Vac	EO-3 150VA	N/A
	Q4L/LAL/LH L			LAMOP
MAMO1	MA/MH	120 Vac	EO-3 50VA	N/A
	MAL/MHL			FAMOP
<b>Top Mounted Motor Operators</b>				
KAMO2120AC	KA/KH/KC/KI	120 Vac	EO-4 300VA	N/A
KAMO2240AC	KA/KH/KC/KI	240 Vac	EO-4 300VA	
KAMO224DC	KA/KH/KC/KI	24 Vac		
KAMO2125DC	KA/KH/KC/KI	125 Vac		
LAMO2120AC	Q4/LA/LH	120 Vac	EO-4 300VA	N/A
LAMO2240AC	Q4/LA/LH	240 Vac	EO-4 300VA	
LAMO224DC	Q4/LA/LH	24 Vac		
LAMO2125DC	Q4/LA/LH	125 Vac		
MAMO2120AC	MA/MH	120 Vac	EO-1 300VA	N/A
MAMO2240AC	MA/MH	240 Vac	EO-1 300VA	
MAMO224DC	MA/MH	24 Vac		
MAMO2125DC	MA/MH	125 Vac		
PAMO2	PA/PH/PC	120 Vac 48 Vdc 24 Vdc	EO-1 1000VA	

# Thermal-Magnetic / Magnetic Only Molded Case Circuit Breakers Accessories

Figure 24: Electrical Operator Side Mount Dimensions and Wiring Diagram

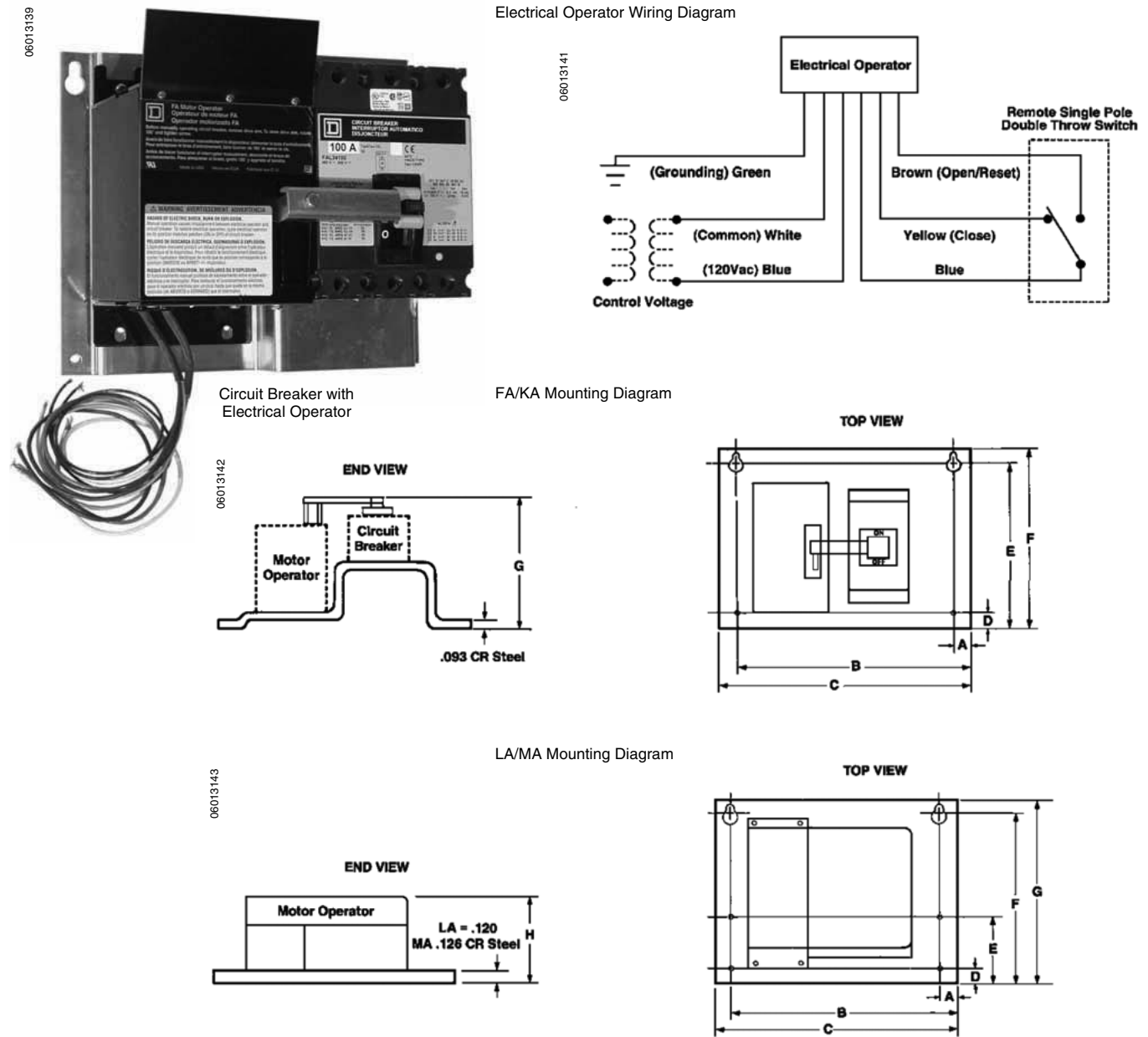
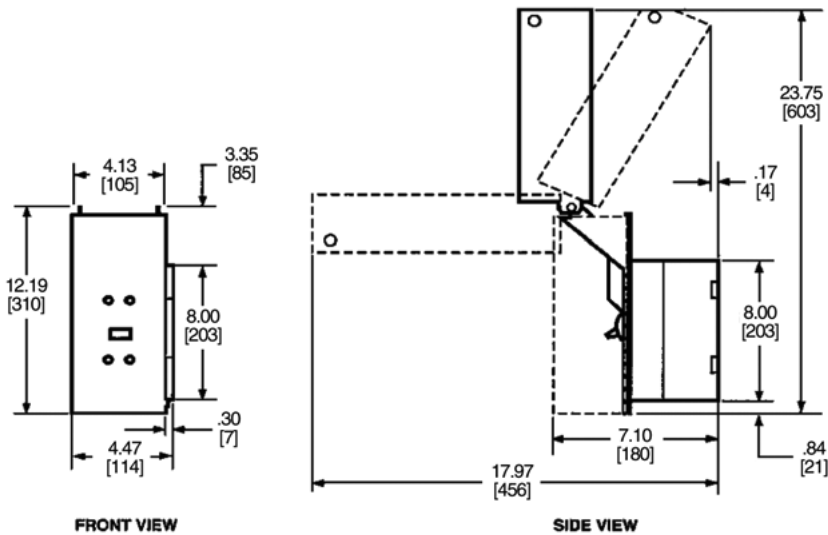
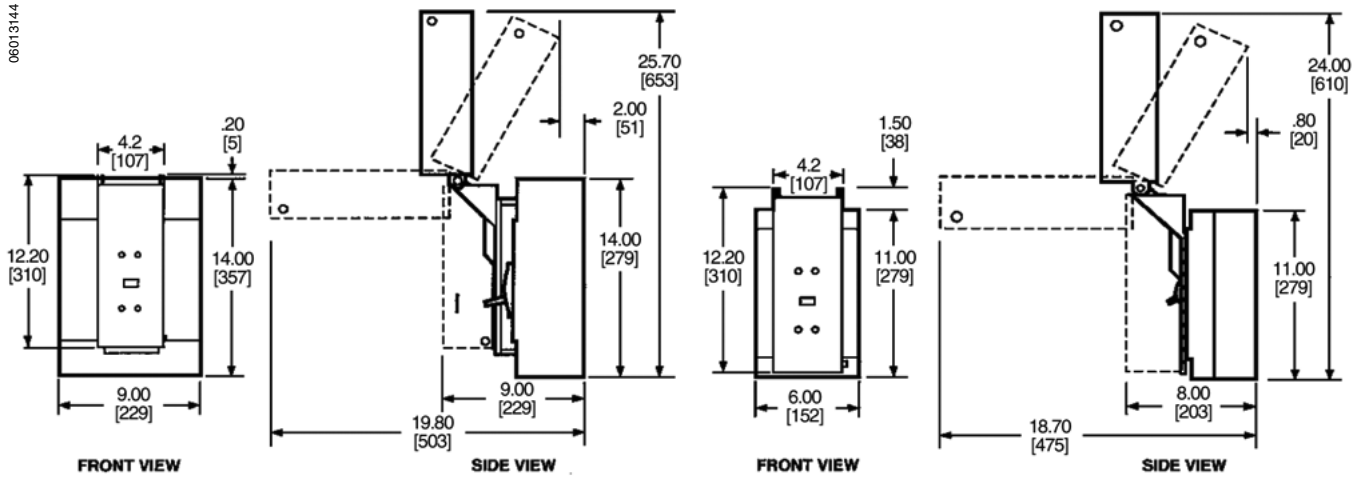

Table 65: Electrical Operator Mounting Dimensions, Inches (mm)

Electrical Operator	A		B		C		D		E		F		G		H	
	IN	mm	IN	mm	IN	mm	IN	mm	IN	mm	IN	mm	IN	mm	IN	mm
FAMO1	.40	10.16	10.20	259.08	10.69	269.24	.40	10.16	7.72	196.09	8.58	217.93	5.72	14.29	—	—
KAMO1	.40	10.16	10.20	259.08	10.50	269.24	.40	10.16	7.72	196.09	8.58	217.93	5.81	147.57	—	—
LAMO1	.50	12.70	12.06	306.32	12.50	317.50	2.38	60.45	6.13	166.70	9.63	244.60	12.25	311.15	7.53	191.26
MAMO1	.45	11.43	15.06	382.52	14.94	379.48	2.37	60.20	6.74	171.19	10.88	276.35	13.50	342.90	7.53	191.26

# Thermal-Magnetic / Magnetic Only Molded Case Circuit Breakers Accessories

**Figure 25: Top Mount Electrical Operator Dimensions and Wiring Diagrams**



Top Mounted Electrical Operator

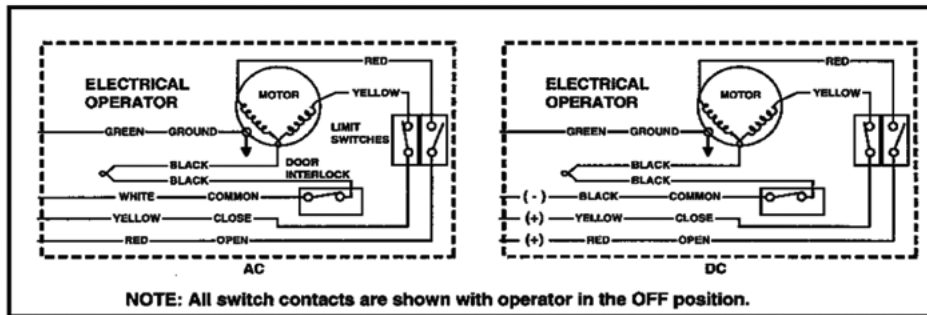

Internal Schematic

# Thermal-Magnetic / Magnetic Only Molded Case Circuit Breakers Accessories

Figure 26: PAMO2 Electrical Operator Suggested Wiring Diagrams

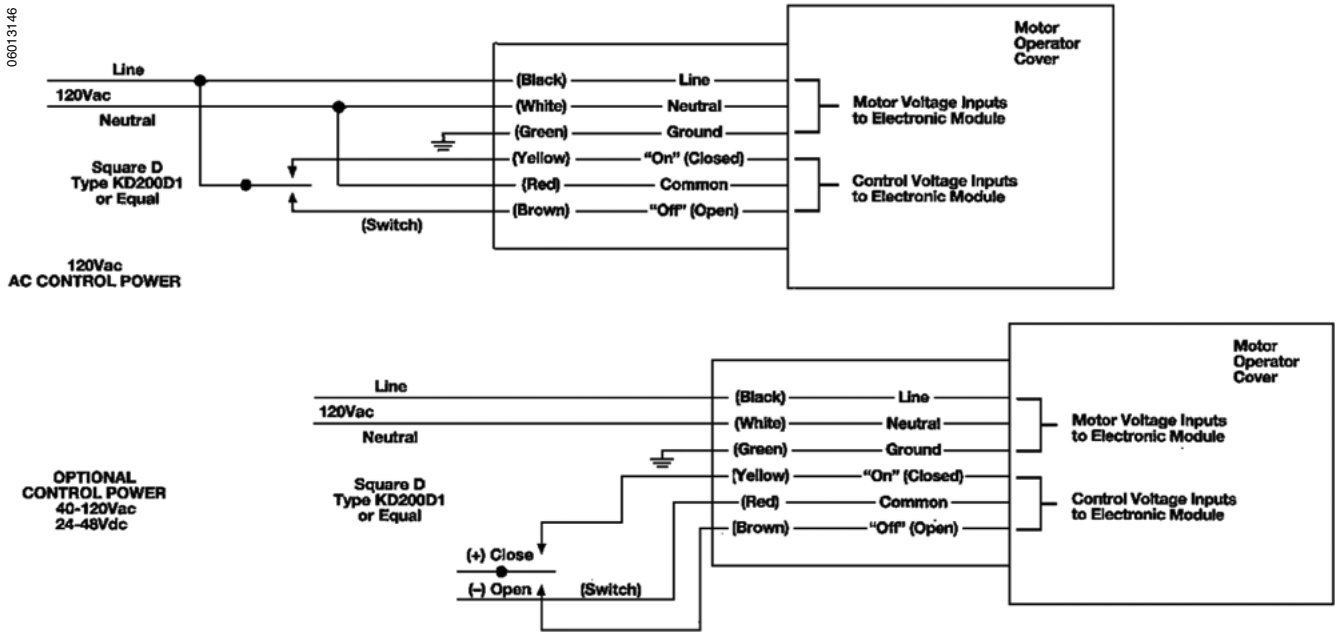

**Control Voltage:**

Switches shown in the suggested wiring diagrams can be,

- Momentary contact,
- Solid state contacts
- Continuous contracts.

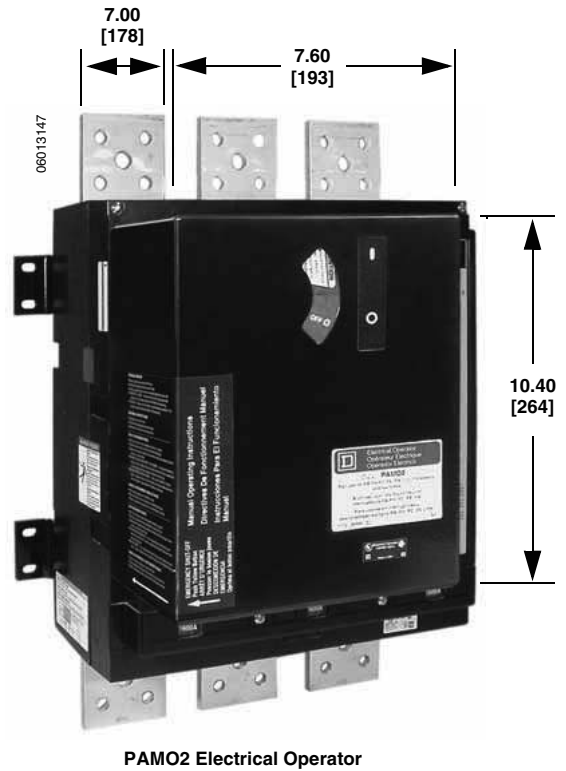
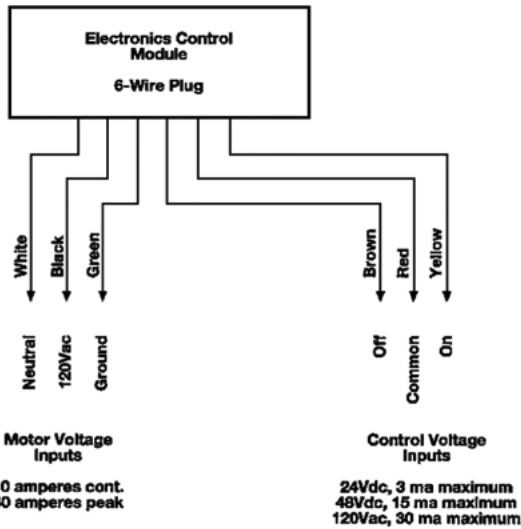

# Thermal-Magnetic / Magnetic Only Molded Case Circuit Breakers Accessories

## Circuit Breaker Handle Accessories

Several handle accessories are available to lock the circuit breaker. See table below to select the desired accessories.

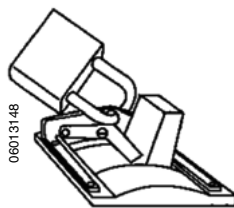

06013148  
Padlock Attachment

**Table 66: Circuit Breaker Handle Accessories—Selection Data**

Accessories	Circuit Breaker	No. of Poles	Catalog Number	Locks Circuit Breaker	
				ON <sup>★</sup>	OFF
Handle Padlock Attachment	PA, PC	2, 3	PAPAF	—	X
	FY	1	HPAFYQ	X	X
	Q2	2, 3	HPAFYQ	X	X
	FA, FH, FC	1, 2, 3	HPAFK	X	X
	FI, KI, KA, KH, KC	2, 3	HPAFK	X	X
	LA, LH, Q4, MA, MH	2, 3	HPALM	X <sup>▲</sup>	X
	LC, LI	2, 3	HPALI	X	X
	NA, NC	2, 3	HPANE	X	X
Handle Extension	LA, LH, Q4	2, 3	LAHEX	—	—
	MA, MH, NA, NC	2, 3	MAHEX	—	—
Handle Extension & Padlock Attachment	LC, LI	2, 3	AHEXLI	—	—
	LA, LH, Q4, MA, MH	2, 3	HPAXLM	X <sup>★</sup>	X
Handle Tie	2-FA	3	FKHT	—	—
	2-KA, 2-FI or 2-KI or 1-FI & 1-KI	2, 3	FKHT	—	—
	2LA or 2 Q4	2, 3	LAHT	—	—
California Title 24 Combination Handle Tie & Lock-off	FY	(3) Single Pole	FY3HT	—	—
	FA, FH, FC	(3) Single Pole	FY3HT	—	—

<sup>★</sup> Circuit breaker will trip free when locked in the ON position.

<sup>▲</sup> MA, MH circuit breakers will not lock in the ON position.

## Circuit Breaker Cylinder Locks

A key cylinder lock prevents the circuit breaker from being reset or turned ON. Cylinder locks **cannot** be used to lock the circuit breaker in the ON position. The cylinder lock key can be removed in the UNLOCKED or LOCKED OFF position. A key cylinder lock is available for Square D<sup>®</sup> FA, KA, LA and MA frame circuit breakers.

**Table 67: Cylinder Lock—Selection Data**

Accessory	Circuit Breaker	Factory Installed Catalog No. (Suffix)	Field Installed Catalog Number
Cylinder Lock	FA, FH, FC, FI, KA, KH, KC, KI	CL <sup>★</sup>	—
	LA, LH, Q4	—	LA1CL
	MA, MH	—	MA1CL

<sup>★</sup> Factory installed cylinder locks are available for -pole circuit breakers only. Cylinder locks are not available on FA/FH Mag-Gard<sup>®</sup> magnetic only circuit breakers.

## Walking Beam Mechanical Interlock

The walking beam mechanical interlock is used with two circuit breakers to maintain essential loads during power outages. It is UL Listed for FA, KA, LA and MA circuit breakers, 15 ampere through 1000 ampere. Manual and automatic transfer schemes use these interlocked circuit breakers.

Mechanically interlocked circuit breakers are intended to prohibit both power sources from being simultaneously connected to the load. The circuit breakers are equipped with an actuator button that operates with and detects the position of the circuit breaker contacts.



06013149  
LA1CL Cylinder Lock

## Thermal-Magnetic / Magnetic Only Molded Case Circuit Breakers Accessories

Walking beam interlocks are available with circuit breakers for unit mounting, but identical frame size breakers must be used. The circuit breakers can be manually or motor operated.

### ■ Unit Mounting

Pre-drilled and tapped mounting pans ease the mounting of all required components. To establish the correct dimensional relationships, Square D suggests using the mounting pans when installing these interlocks.

**Table 68: Walking Beam—Selection Data**

Circuit Breaker		Walking Beam Assembly	Mounting Pan
Catalog Number		Catalog Number	Catalog Number
Prefix	Suffix		
<b>Manually Operated</b>			
FAL	WB	FA4WB	FAWBP4
KAL	WB	KA4WB	KAWBP4
LAL, LHL	WB	LA6WB	LAWBP6
MAL, MHL	WB	MA9WB	MAWBP9
<b>Electrically Operated</b>			
FAL	WBMO	FA9WB	KAWBP9
KAL	WBMO	KA9WB	KAWBP9
LAL, LHL	WBMO	LA10WB	LAWBP10
MAL, MHL	WB	MA13WB	MAWBP13

**Figure 27: Walking Beam Mechanical Interlock**



Requires two circuit breakers with WB suffix, one walking beam assembly and one mounting pan.

# Thermal-Magnetic / Magnetic Only Molded Case Circuit Breakers Accessories

## ■ Dimensions

The dimensions shown below are for two unit-mounted circuit breakers that are installed on the appropriate mounting pan include the walking beam assembly. The dimensions also show the electrically operated version.

06013151

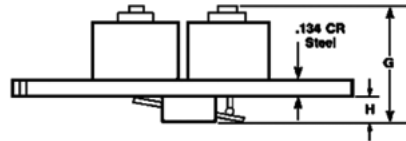
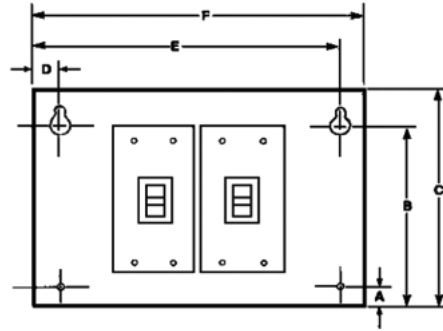

Requires two circuit breakers with WB suffix, one walking beam assembly and one mounting pan.

06013152

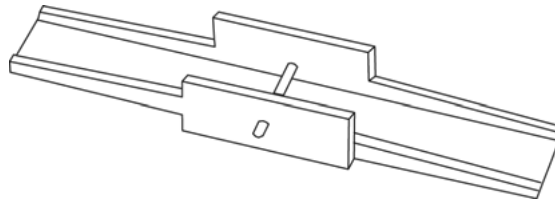

**Table 69: Electrical Operator Mounting Dimensions, Inches (mm)**

Circuit Breaker	Dimensions (Inches)							
	A	B	C	D	E	F	G	H
<b>Manually Operated</b>								
FAL	.562	5.74	6.38	.50	10.25	10.75	5.77	1.5
KAL	.50	7.81	8.50	.50	10.25	10.75	6.38	1.5
LAL, LHL	.75	10.25	11.25	.52	13.37	14.00	7.48	1.5
MAL, MHL	.68	12.39	14.12	.56	19.56	20.12	8.13	1.5
<b>Electrically Operated</b>								
FAL	.50	7.88	8.50	.50	19.25	19.75	7.22	1.5
KAL	.50	9.75	10.25	.50	19.25	19.75	7.31	1.5
LAL, LHL	.75	12.75	13.75	.56	22.56	23.12	9.03	1.5
MAL, MHL	.68	13.43	14.12	.56	28.56	29.12	8.13	1.5

# Thermal-Magnetic / Magnetic Only Molded Case Circuit Breakers Accessories

## Operating Mechanisms

### ■ Door Mounted

Type L door mounted, variable depth operating mechanisms are kits featuring heavy duty, all metal construction with trip indication. All of the operating mechanisms can be padlocked in the OFF position when the enclosure door is open. The kits include handle assemblies, padlocks, door drilling template and shafts. Handle assemblies can be locked in the OFF position with up to three padlocks that also lock the door closed. The 3-inch handle accepts one padlock. A door drilling template is supplied with each kit to ease installation. The kits are rated for installation into NEMA Type 1, 3, 3R and 12 enclosures. All NEMA Type 1, 3, 3R and 12 handle assemblies are painted; the handle is flat black; and the base ring is silver.

**Figure 28: Door Mounted Variable Depth Operating Mechanisms**

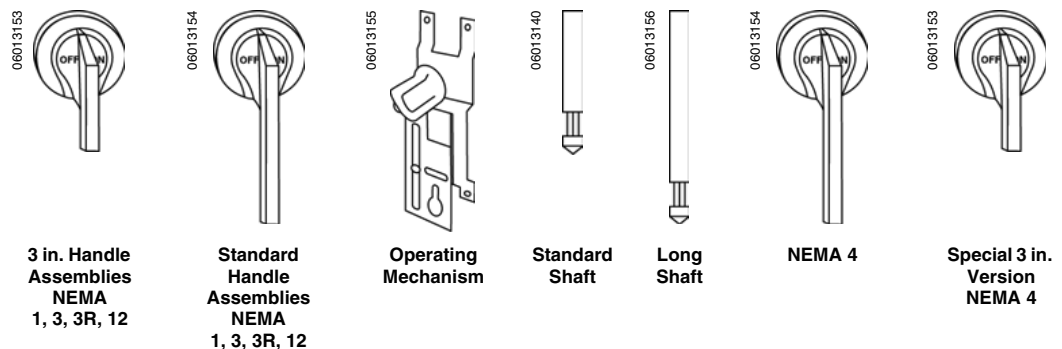

### ■ Flange Mounted, Variable Depth

Designed for installation in custom built control enclosures where main or branch circuit protective devices are required. All circuit breaker operating mechanisms are field convertible or either right- or left-hand flanged mounting.

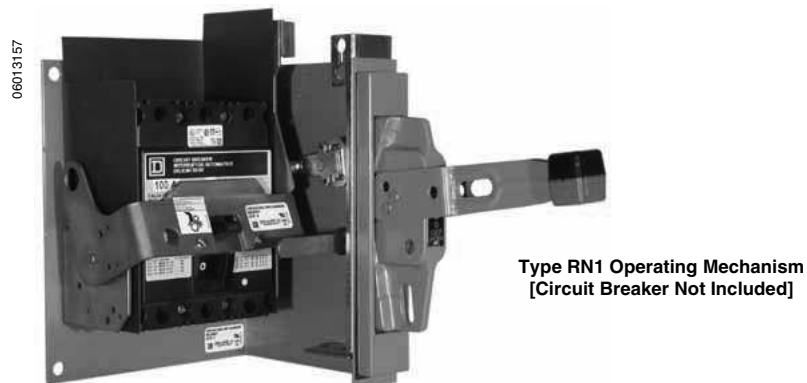

### ■ Door Closing Mechanisms

Class 9423 door closing mechanisms are designed for use on small to medium size single door control enclosures. They are primarily designed for use with the Class 9422 flange-mounted disconnect switches and circuit breaker operating mechanisms. However, they can be used independently.

When used on properly designed and gasketed NEMA Type 12 industrial use enclosures, they meet NFPA 70 standards.

# Thermal-Magnetic / Magnetic Only Molded Case Circuit Breakers Accessories

## UL Listed Terminations

Square D supplies all thermal-magnetic molded case circuit breakers, Mag-Gard® instantaneous trip circuit breakers and molded case switches (1200 ampere frame and smaller) with mechanical-type aluminum alloy lugs suitable for use with either aluminum or copper wire.

I-line® circuit breakers are supplied with mechanical-type lugs on the OFF end.

Additionally, Square D offers a large selection of UL Listed lugs to meet individual termination requirements for almost every application. Besides the mechanical lugs, Square D can supply copper mechanical lugs or our exclusive aluminum or copper Versa-Crimp® compression lugs. Power distribution connectors permit multiple conductor installation in control panel applications.

## Control Wire Terminations

Mechanical lugs with provisions for separate control wire terminations are available in kit form. They can be field or factory installed.

The FA-T adaptor has been designed for mounting on the FA 100 ampere frame circuit breaker, between the breaker lug and its terminal. It has a tab extension suitable for attachment of 250-inch slip-on connectors. Fully insulated type connectors must be used to prevent live parts from extending into the wiring gutter area.

On larger frame circuit breakers, provision is made for securing the control wire directly to the circuit breaker lug with provided #6-32 screws, threaded directly into the lug body. Use ring type connectors crimped to the control wire to provide secure terminations for control wiring. These control terminations are UL recognized components for use with Square D® circuit breakers.

**Table 70: Control Wire Termination Kits—Selection Data**

Breaker Prefix	Catalog Number	Qty. Per Kit	UL Listed Wire Size
FA, FAL, FH, FHL, FC, FCL	FA-T★	2	—
KA, KAL, KH, KHL, KC, KCL	AL250 KAT	2	One #4–#300 MCM Al or Cu
LA, LAL, LH, LHL		2	One #1–#600 MCM Al or Cu or Two #1–#250 MCM Al or Cu
MA, MAL, MH, MHL	AL900 LAT	1	Three 3/0–#500 MCM Al or Cu
NA, NAL, NC, NCL	AL1200 NE6T	1	Four 3/0–#600 MCM Al or Cu

★ Use fully insulated 250 slip-on connectors.

## Lug Delete

In certain applications, a circuit breaker does not require lugs on one or both ends. This can be accomplished by ordering a standard circuit breaker and removing the lugs. The alternative is to order the circuit breaker without lugs.

**Table 71: Lug—Selection Data**

Lug Configuration		Circuit Breaker Catalog Number
ON End	OFF End	“Prefix” Indication
No Lugs	No Lugs	“F” (e.g. KAF36150)
No Lugs	Lugs	“P” (e.g. KAP36150)

# Thermal-Magnetic / Magnetic Only Molded Case Circuit Breakers Accessories

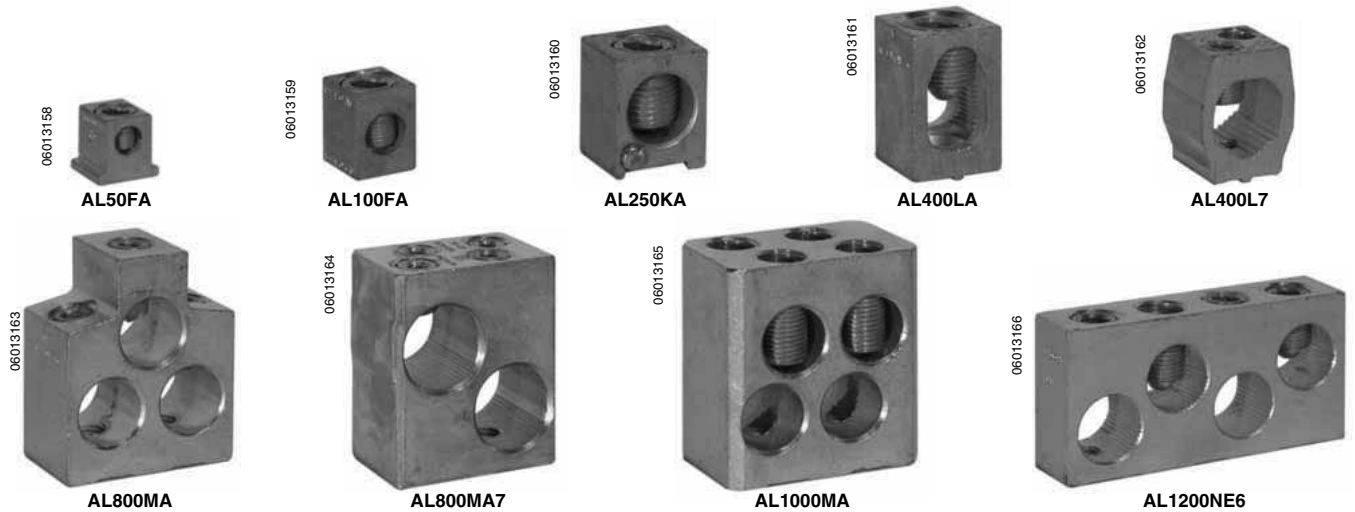

**Table 72: Mechanical Lug Kit Wire Ranges and Torques—Selection Data**

Lug Kit	No. of Lugs Per Kit	Circuit Breaker	Number of Wires Per Lug and Wire Ranges			Lug Mounting Screw Torque		Wire Binding Screw Torque		
			No. Wires	Domestic	Metric	Lb-in.	N•m	Wire	Lb-in.	N•m
AL50FA	3	FA, FH, FI	1	#14–#4 Cu or #12–#4 Al	2.5–25 mm <sup>2</sup> 4–25 mm <sup>2</sup>	40	4.5	Cu #14–#4 STR/SOL Al #12–#4 STR Al #12–#10 SOL	35 35 15	4.0 4.0 1.7
AL100FA4	3	FC	1	#14–#3 Cu or #12–#1 Al		65	7.3	Cu #14–#3 STR Cu #14–#8 SOL Al #8–#1 STR Al #12–#10 SOL	65 65 65 65	7.3 7.3 7.3 7.3
AL100FA	3	FA, FH, FI	1	#14–1/0 Cu or #12–1/0 Al	2.5–50 mm <sup>2</sup> 4–50 mm <sup>2</sup>	40	4.5	Cu #14–1/0 STR Al #12–1/0 STR Al #12–#10 SOL	80 80 40	9.0 9.0 4.5
AL100TF	3	FA, FH	1	#12–#3 Cu		50	5.7	Cu #12–#3 STR Cu #12–#10 SOL	50 50	5.6 5.6
AL250KA	3	KA, KH, KC, KI	1	#6–#350 kcmil	25–185 mm <sup>2</sup>	80	9.0		250	28.2
AL250KI	3	KC, KI	1	1/0–#350 kcmil	50–185 mm <sup>2</sup>	80	9.0		250	28.2
AL400LA	1	Q4, LA, LH	1 2	#0–#600 kcmil or #1–#250 kcmil	50–300 mm <sup>2</sup> 50–120 mm <sup>2</sup>	180	20.0		300	33.9
AL800MA7	1	MA, MH	2	#500–#750 kcmil	240–300 mm <sup>2</sup>	180	20.0		300	33.9
AL900MA	1	MA, MH	3	3/0–#500 kcmil	95–240 mm <sup>2</sup>	180	20.0		300	33.9
AL1000MA	1	MA, MH	4	1/0–#350 kcmil	50–185 mm <sup>2</sup>	180	20.0		300	33.9
AL1200NE6	1	NA, NC	4	3/0–#600 kcmil	95–300 mm <sup>2</sup>	250	28.2		330	37.3
AL2500PA	2	PAF, PHF, PCF	1	3/0–#750 kcmil	95–300 mm <sup>2</sup>	840			550	
CU30FA4	3	FC	1	#14–#10 Cu		N/A	N/A	#14–#10 STR/SOL	35	4.0
CU100FA	3	FA, FH, FI	1	#14–#1 Cu	2.5–50 mm <sup>2</sup>	50	5.7	Cu #3–#1 STR Cu #6–#4 STR Cu #8 STR/SOL Cu #14–#10 STR/SOL	50 45 40 35	5.7 5.1 4.5 4.0
CU100TF	3	FA, FH	1	#12–#3 Cu		50	5.7	Cu #12–#3 STR Cu #12–#10 SOL	50 50	5.7 5.7
CU250KA	3	KA, KH, KC, KI	1	#6–#250 MCM Cu	16–20 mm <sup>2</sup>	80	9.0		250	22.6
CU400LA	1	Q4, LA, LH	2	#1–#600 MCM Cu #1–#250 MCM Cu	50–300 mm <sup>2</sup> 50–120 mm <sup>2</sup>	180	20.0		300	33.9
CU1000MA	1	MA, MH	3	3/0–#500 MCM Cu	95–240 mm <sup>2</sup>	300	33.9		300	33.9
CU1200NE6	1	NA, NC	4	3/0–#600 MCM Cu	95–300 mm <sup>2</sup>	250	28.2	330		37.3

STR = Stranded, SOL = Solid

## Thermal-Magnetic / Magnetic Only Molded Case Circuit Breakers Accessories



**Table 73: Versatile Compression Lug Kit Wire Ranges and Mounting Screw Torques—Selection Data**

Lug Kit	No. of Lugs Per Kit	Circuit Breaker	Versatile System Wire Ranges <sup>★</sup>		Lug Mounting Screw Torque		Versa-Crimp <sup>®</sup> Tool Type	Mounting Hole Dia. (Inches)
			Domestic	Metric	Lb-in.	N•m		
VC100FA	1	FA, FH, FC, FI	#8–1/0	10–50 mm <sup>2</sup>	50	5.7	VC-6	.265
VC250KA3	1	KA, KH, KC, KI	#4–#300 MCM	25–150 mm <sup>2</sup>	50	5.7	VC-6	.265
VC250KA35	1	KA, KH, KC, KI	#250–#350 MCM	120–185 mm <sup>2</sup>	50	5.7	VC-6	.375
VC400LA3	2	LA, LH, Q4	#4–#300 MCM	25–150 mm <sup>2</sup>	180	20.0	VC-6	.375
VC400LA5	1	LA, LH, Q4	2/0–#500 MCM	70–240 mm <sup>2</sup>	250	28.2	VC-6	.390
VC400LA7	1	LA, LH, Q4	#500–#750 MCM Al or #500 MCM Cu	240–300 mm <sup>2</sup> Al or 240 mm <sup>2</sup> Cu	250	28.2	VC-6FT or VC-8	.390
VC800MA5	2	MA, MH	2/0–#500 MCM	70–240 mm <sup>2</sup> Cu	300	33.9	VC-6	.500
VC800MA7	2	MA, MH	#500–#750 MCM Al or #500 MCM Cu	240–300 mm <sup>2</sup> Al or 240 mm <sup>2</sup> Cu	300	33.9	VC-6FT or VC-8	.500
VC1200NE5	4	NA, NC	2/0–#500 MCM	70–240 mm <sup>2</sup> Cu	600	67.8	VC-6	.500
VC1200NE7	4	NA, NC	#500–#750 MCM Al or #500 MCM Cu	240–300 mm <sup>2</sup> Al or 240 mm <sup>2</sup> Cu	600	67.8	VC-6FT or VC-8	.500
VC2000PA5	1	PA, PH	2/0–#500 MCM	70–240 mm Cu <sup>2</sup>	600	67.8	VC-6	.500
VC2000PA7	1	PA, PH, PCF	#500–#750 MCM Al or #500 MCM Cu	240–300 mm <sup>2</sup> Al or 240 mm <sup>2</sup> Cu	800	67.8	VC-6FT or VC-8	.500
CVC100FA	1	FA, FH, FI	#6–1/0	16–50 mm <sup>2</sup> Cu	50	5.7	VC-6	.265
CVC250KA3	1	KA, KH, KC, KI	2/0–#300 MCM Cu	70–150 mm Cu <sup>2</sup>	50	5.7	VC-6	.265
CVC400LA3	2	LA, LH, Q4	2/0–#300 MCM Cu	70–150 mm <sup>2</sup> Cu	180	20.0	VC-6	.375
CVC400LA5	1	LA, LH, Q4	#250–#500 MCM Cu	120–240 mm <sup>2</sup> Cu	250	28.2	VC-6	.390
CVC800MA5	2	MA, MH	#250–#500 MCM Cu	120–240 mm <sup>2</sup> Cu	300	33.9	VC-6	.500
CVC1200NE5	4	NA, NC	#250–#500 MCM Cu	120–240 mm <sup>2</sup> Cu	600	67.8	VC-6	.500
CVC1200NE7	4	NA, NC	#500–#750 MCM Cu	240–300 mm <sup>2</sup> Cu	600	67.8	VC-6FT or VC-8	.500

<sup>★</sup> Unless otherwise specified, wire ranges are for both aluminum and copper conductors.

# Thermal-Magnetic / Magnetic Only Molded Case Circuit Breakers Accessories



PDC4LA250

## Power Distribution Connectors

Power distribution connectors can be used for multiple lead wire connections on one circuit breaker. Field installable kits, including aluminum alloy connectors and all necessary mounting hardware, are available for the Square D® FA, KA, LA, Q4 and MA molded case circuit breakers. Each is UL Listed (per UL Standard 486a) for copper wire only. Power distribution connectors are for use on the OFF end of the circuit breaker only, when the OFF end is connected to the load.

**Table 74: Power Distribution Connectors—Selection Data**

Lug Kit	No. of Lugs Per Kit	Circuit Breaker	Wire Ranges (Copper only)		Lug Mounting Screw Torque		Wire Binding Screw Torque		
			Domestic	Metric	Lb-in.	N•m	Wire Size	Lb-in.	N•m
PDC6FA6	FA, FH, FI	6	#14–#6	2.5–16 mm <sup>2</sup>	40	4.5	#14–#10 #8–#6	20 25	2.3 2.8
PDC3FA2	FA, FH, FI	3	#14–#2	2.5–35 mm <sup>2</sup>	40	4.5	#14–#8 #6–#2	35 40	4.0 4.5
PDC6KA4	KA, KH, KC, KI	6	#14–#4	2.5–25 mm <sup>2</sup>	80	9.0	#14–#10 #8–#4	20 35	2.3 4.0
PDC3KA20	KA, KH, KC, KI	3	(2) #14–#1	2.5–50 mm <sup>2</sup>	80	9.0	#14–#8 #4–#1	35 40	40 45
			(1) #12–2/0	4–70 mm <sup>2</sup>			#12–2/0	50	57
PDC6LA20	LA, LH, Q4	6	#12–2/0	4–70 mm <sup>2</sup>	180	20.0	#12 #6–#10 #20–#4	35 45 50	4.0 5.1 5.7
PDC12LA4	LA, LH, Q4	12	#14–#4	2.5–25 mm <sup>2</sup>	180	20.0	#14–#10 #8–#4	20 35	2.3 4.0
PDC4LA250	LA, LH, Q4	4	(3) #14–#1	2.5–35 mm <sup>2</sup>	180	20.0	#6–#14 #1–#4	35 40	4.0 4.5
			(1) 2/0 #250 kcmil	35–120 mm <sup>2</sup>			2/0–4/0 #250 kcmil	180 190	14.7 21.4
PDC6MA20	MA, MH, ME, MX	6	#12–2/0	4.70 mm <sup>2</sup>	180	20.0	#12 #6–#10 2/0–#4 2/0–#4	35 45 50 50	40 51 57 57
PDC12MA4	MA, MH, ME, MX	12	#14–#4	2.5–25 mm <sup>2</sup>	180	20.0	#14–#10 #8–#4	20 35	2.3 4.0

## Rear Connecting Studs



Rear connecting studs are designed to allow rear termination in applications, such as control panels where wire gutter space may be limited. The studs can be bolted directly to the bus bars or lugs can be attached to the studs. Long and short studs should be alternated on adjacent poles to assure proper electrical clearance. These studs are not UL Listed.

**Table 75: Rear Connecting Studs—Selection Data**

Circuit Breaker Catalog Number Prefix	Ampere Ratings	Stud Catalog Number	Dimensions			
			Inches Millimeters			
			Overall Length	Back of Circuit Breaker	Diameter	Threads / Inches
FAL, FHL	15–100	FAS–20	2.25	2.00	0.125	16
			5.72	5.08	0.318	5.30
FAL, FHL	15–100	FAS–42	4.875	4.25	0.125	16
			2.383	0.795	0.318	6.30
KAL, KHL	70–225	KAS–21	2.25	2.125	0.50	13
			5.72	5.398	1.27	5.19

*Continued on next page*

## Thermal-Magnetic / Magnetic Only Molded Case Circuit Breakers Accessories

**Table 75: Rear Connecting Studs—Selection Data** *(continued)*

Circuit Breaker Catalog Number Prefix	Ampere Ratings	Stud Catalog Number	Dimensions			
			Inches Millimeters			
			Overall Length	Back of Circuit Breaker	Diameter	Threads / Inches
KAL, KHL	70–225	KAS–45	2.125	4.825	0.50	13
			13.018	11.748	1.27	5.19
LAL, LHL	125–400	LAS–54	6.188	5.50	0.75	16
			15.718	13.97	1.905	6.30
LAL, LHL	125–400	LAS–114	12.188	11.50	0.75	16
			30.958	29.21	1.905	6.30
MAL, MHL	300–1000	MAS–54	6.188	5.50	1.25	12
			15.718	13.97	3.175	4.72
MAL, MHL	300–1000	MAS–114	12.188	11.50	1.25	12
			30.958	29.21	3.175	.472

Use alternate length studs on adjacent poles to obtain proper voltage spacing.

### I-Line® Accessories

#### ■ Top-feed I-Line

I-Line panelboards may require the use of a top-feed I-Line circuit breaker in applications where a top-feed main circuit breaker is required. This involves having the I-Line jaw connectors on the OFF end of the circuit breaker, as opposed to the standard location on the ON end. To designate this construction, place MT at the end of the circuit breaker catalog number (i.e. KA36150 becomes KA36150MT). Not available for FY circuit breakers.

#### ■ I-Line Electric Joint Compound

I-Line circuit breakers, I-Line busway plug-on units, and I-Line panelboards and switchboards are supplied with factory applied joint compound on the plug-on connectors. The compound contributes to the overall performance of the connection. If removed, the joint compound should be reapplied. Order catalog number PIC-7201 for a 2-ounce container of compound especially formulated for the I-Line, QMB and Model IV MCC connections.

### KA Insert Kit

The standard lugs supplied with KA, KH, KC and KI circuit breakers and molded case switches (Series 2 and higher) are secured with a screw fastened through the circuit breaker terminal into the lug body. If the standard lug is removed and a bolted connection to the circuit breaker terminal pad is desired, the AL250KAIN threaded insert kit is required to make this connection. The AL250KAIN is inserted below the terminal pad and secured by a wire retaining clip. See figure below.

**Table 76: Insert Kit—Selection Data**

Kit Catalog	Inserts Per kit	Circuit Breakers
AL250KAIN	3	KA, KH, KC, KI

# Thermal-Magnetic / Magnetic Only Molded Case Circuit Breakers Accessories

## LC, LI, LE, LX and LXI Circuit Breaker Termination Clip Kit

The standard lugs supplied with LC and LI circuit breakers are secured by means of a screw fastened through the circuit breaker terminal into the lug body. If the standard lug is removed and a bolted connection to the circuit breaker terminal is desired, the AL600IN threaded terminal clip kit is required to make this connection. The AL600IN clip snaps onto the bottom of the terminal. For ordering information, see the chart below.

**Table 77: Termination Clip Kit—Selection Data**

Kit Catalog	Inserts Per kit	Circuit Breakers
AL250KAIN	3	KA, KH, KC, KI

## Replacement Handles

Replacement handle assemblies for PAF, PHF and PCF circuit breakers (manufactured after March 1975) are available as follows:

**Table 78: Replacement Handles—Selection Data**

Circuit Breaker Catalog Number Prefix	Replacement Handle Catalog Number
PAF, PHF, PCF	HRPA

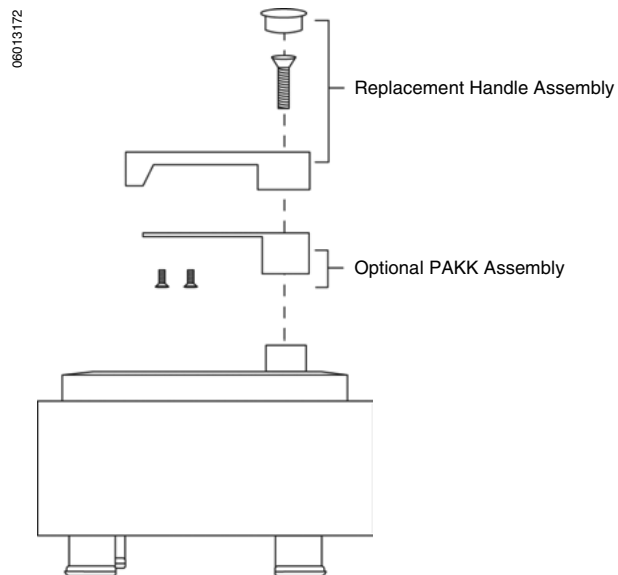

## Mechanical Key Interlock Adaptor Plate

An adaptor plate is available for PAF, PHF and PCF circuit breakers that can be added under the circuit breaker handle to allow mechanical interlocking with a key interlock (not included). The kit, Catalog Number PAKK, includes all the necessary hardware to mount onto the circuit breaker handle.

# Thermal-Magnetic / Magnetic Only Molded Case Circuit Breakers Accessories

## Visi-blade® Circuit Breakers



Mag-Gard Circuit Breaker  
LAF36400

Visi-blade construction is a modification to the cover of a thermal-magnetic circuit breaker, a molded case switch, or a Mag-Gard® circuit breaker, which provides a window through which the position of the movable contacts can be verified. Luminescent paint is applied to the moveable contact arms to indicate their position. Visi-blade circuit breakers are UL Listed except for the FH. Visi-blade construction is available only on circuit breakers listed in the following table. Add suffix letter V to the circuit breaker catalog number (i.e. FAL36100V).

**Table 79: Visi-blade Circuit Breakers**

Circuit Breaker Prefix	Amperes
FA, FH★	15–100
KA, KH	70–250
LA, LH	125–400
MA, MH	300–1000

★ FH Visi-blade circuit breaker is not UL Listed.



## Sub-feed Lugs

Sub-feed lug kits are UL Listed for use on listed equipment. They have plug-on jaw construction and plug-on to the I-Line® bus stack in the same manner as branch circuit breakers. Lugs on these devices accommodate the same wire sizes as the equivalent ampere rated circuit breakers.

**Table 80: I-Line Sub-feed Lug Kits—Selection Data**

Ampere Rating	Ht. (In.)	Catalog Number	Max. Short Circuit System Ratings RMS Symmetrical Amperes			Protected by Circuit Breaker	Standard I-Line Panelboard
			240 Vac	480 Vac	600 Vac		
100	4-1/2	SL100	65,000	25,000	18,000	FH	HCN, HCM, HCW, HCWM, HCWM-U
225	4-1/2	SL225	65,000	35,000	25,000	KH	HCM, HCW, HCWM, HCWM-U
			200,000	200,000	100,000	KI	
400	6	SL400★	65,000	35,000	25,000	LH	HCW, HCWM, HCWM-U
800	9	SL800	65,000	65,000	25,000	MH	HCM, HCW, HCWM, HCWM-U
1200	15	SL1200	126,000	100,000	65,000	NC	HCW, HCWM, HCWM-U

★ SL400 cannot be used in HCM panelboards due to inadequate wire bending space.

**Table 81: Terminations**

Catalog No.	No. Poles	Ampere Rating	Standard Lug Kit Catalog No.	Standard Lug Wire Size★
SL100	3	100	AL100FA	#4-1/0 Cu or #12-1/0 Al
SL225	3	225	—	#4-#300 kcmil
SL400	3	400	AL400LA	(1) #1-#600 kcmil or (2)-#1-#250 kcmil
SL800	3	800	AL800MA	(3) 3/0-#500 kcmil
SL1200	3	1200	AL1200NE6	(4) 3/0-#600 kcmil

★ Unless otherwise specified, wire sizes apply to both aluminum and copper conductors.

# Thermal-Magnetic / Magnetic Only Molded Case Circuit Breakers



# Thermal-Magnetic / Magnetic Only Molded Case Circuit Breakers

**Schneider Electric USA**

3700 Sixth Street SW  
Cedar Rapids, Iowa 52404 USA  
1-888-Square D  
1-888-778-2733  
www.us.SquareD.com

0601CT9101R12-03 © 2004 Schneider Electric All Rights Reserved  
Replaces Catalog 0601CT9101

**10/2004**